



**PRECISION**<sup>™</sup>  
SURGICAL WORKS

## ARTERY FORCEPS

Arterienklemmen  
Pinzas hemostáticas  
Pinces hémostatiques  
Pinze emostatiche





**Biemer Clip Applying Forcep**  
Without Lock

Catalog #	Size
PRO-04-010-14	14.5 cm (5 ¾")



**Biemer Clip Applying Forcep**  
With Lock

Catalog #	Size
PRO-04-012-14	14.5 cm (5 ¾")

**Biemer Vessel Clip**

Catalog #	Size, Opening, Jaw Length, Closing Pressure
PRO-04-016-14	14 mm, 4 mm, 4 mm, 30 - 40 gr



**Biemer Vessel Clip**

Catalog #	Size, Opening, Jaw Length, Closing Pressure
PRO-04-018-17	17 mm, 7 mm, 5 mm, 30 - 40 gr



**Biemer Vessel Clip**

Catalog #	Size, Opening, Jaw Length, Closing Pressure
PRO-04-020-17	17 mm, 7 mm, 5 mm, 20 - 25 gr



**Biemer-Mueller Approximator**  
Straight, Wide

Catalog #	Size, Opening, Jaw Length, Closing Pressure
PRO-04-024-17	17 mm, 5 mm, 9 mm, 25 - 30 gr

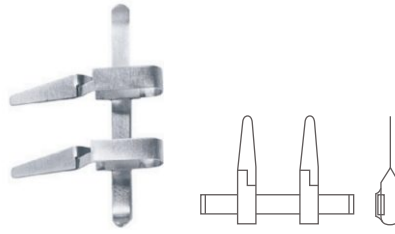

**Biemer-Mueller Approximator**  
Angled, Wide

Catalog #	Size, Opening, Jaw Length, Closing Pressure
PRO-04-025-17	17 mm, 5 mm, 9 mm, , 25 - 30 gr

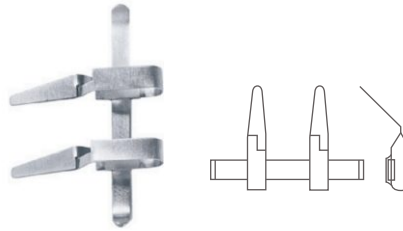

**Biemer-Mueller Approximator**  
Straight, Narrow

Catalog #	Size, Opening, Jaw Length, Closing Pressure
PRO-04-026-13	13 mm, 3 mm, 4.5 mm, 25 - 30 gr
PRO-04-026-17	17 mm, 5 mm, 9 mm, , 25 - 30 gr

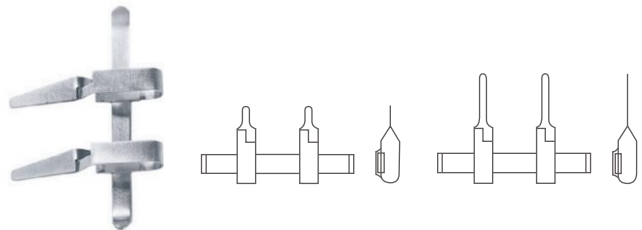

**Biemer-Mueller Approximator**  
Angled, Narrow

Catalog #	Size, Opening, Jaw Length, Closing Pressure
PRO-04-027-17	17 mm, 5 mm, 9 mm. 25 - 30 gr

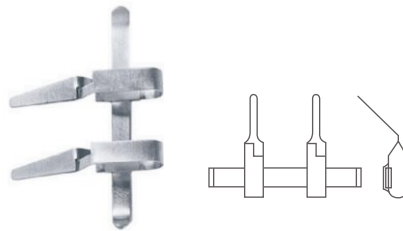

**Mueller Approximator**

Catalog #	Size, Diameter, Closing Pressure
PRO-04-030-01	17 mm, Ø 1 mm, 25 - 30 gr
PRO-04-030-02	17 mm, Ø 2 mm, 25 - 30 gr
PRO-04-030-03	17 mm, Ø 3 mm, 25 - 30 gr
PRO-04-030-04	17 mm, Ø 4 mm, 25 - 30 gr

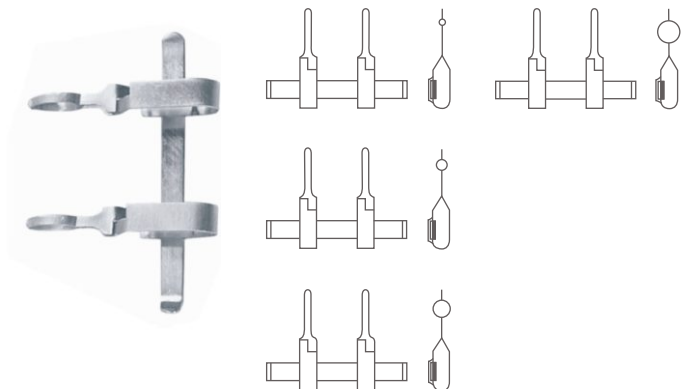

**Nerve Approximator**

Complete With Key

Catalog #	Size
PRO-04-040-00	Standard



**Key For Approximator**

Catalog #	Size
PRO-04-040-01	Standard



**Nerve Approximator**

Approximator Only

Catalog #	Size
PRO-04-040-02	Standard



**Nerve Approximator- Complete With Key**

Needles Exchangeable by Mean of Key

Catalog #	Size
PRO-04-044-00	Standard



**Nerve Approximator**

Approximator With Needles Only

Catalog #	Size
PRO-04-044-02	Standard



**Nerve Approximator**

Spare Needles Only

Catalog #	Size
PRO-04-044-04	Standard



**Clip Applying Forcep**

With Ratchet

Catalog #	Size
PRO-04-046-14	Standard



**Clip Applying Forcep**

Bayonet Shaped, With Ratchet

Catalog #	Size
PRO-04-049-18	18.5 cm ( 7 ¼")



**Mini Vessel Clip**

Catalog #	Size, Jaw Size, Closing Pressure
PRO-04-050-04	13 mm, 4.0 x 0.75 mm, 60 gr
PRO-04-050-06	15 mm, 6.0 x 1.0 mm, 85 gr
PRO-04-050-08	17 mm, 8.0 x 2.0 mm, 100 gr
PRO-04-050-10	20 mm, 10.0 x 2.0 mm, 125 gr



**Dieffenbach Bulldog Clamp**  
Straight

Catalog #	Size
PRO-04-060-06	6 cm (2 1/4")



**Dieffenbach Bulldog Clamp**  
Curved

Catalog #	Size
PRO-04-061-06	6 cm (2 1/4")



**Dieffenbach Bulldog Clamp**  
Straight

Catalog #	Size
PRO-04-062-03	3.5 cm (1 1/2")
PRO-04-062-05	5 cm (2")



**Dieffenbach Bulldog Clamp**  
Curved

Catalog #	Size
PRO-04-063-03	3.5 cm (1 1/2")
PRO-04-063-05	5 cm (2")



**John-Hopkins Bulldog Clamp**

Catalog #	Size
PRO-04-065-35	3.5 cm (1 ½")
PRO-04-065-50	5 cm (2")
PRO-04-065-55	5.5 cm (2 ½")
PRO-04-065-65	6.5 cm (2 ½")
PRO-04-065-70	7 cm (2 ¾")
PRO-04-065-80	8 cm (3 ¼")
PRO-04-065-90	9 cm (3 ½")

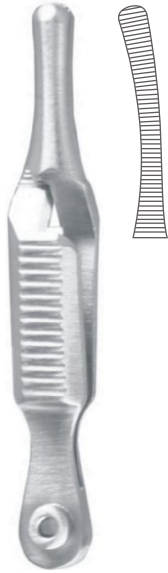

**John-Hopkins Clip Applying Forcep**

Catalog #	Size
PRO-04-067-24	24 cm (9 ½")



**Diethrich Bulldog Clamp**  
Straight

Catalog #	Size, Jaw Length
PRO-04-080-45	45 mm, 8 mm
PRO-04-080-50	50 mm, 12 mm
PRO-04-080-60	60 mm, 20 mm

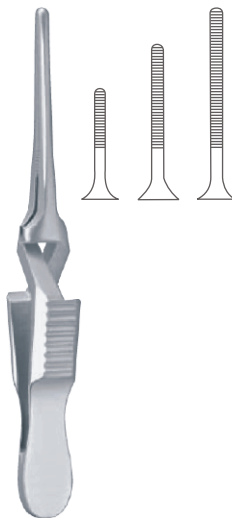

**Diethrich Bulldog Clamp**  
Angled

Catalog #	Size, Jaw Length
PRO-04-081-40	45 mm, 8 mm
PRO-04-081-45	50 mm, 12 mm
PRO-04-081-50	60 mm, 20mm

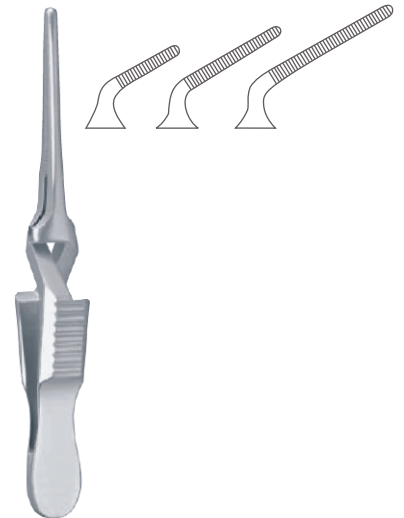

**DeBakey-Diethrich Atrauma Bulldog Clamp**  
Straight

Catalog #	Size, Jaw Length
PRO-04-084-10	45 mm, 10 mm
PRO-04-084-14	50 mm, 14 mm
PRO-04-084-20	60 mm, 20mm

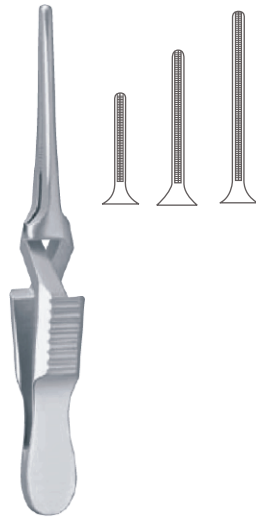

**DeBakey-Diethrich Atrauma Bulldog Clamp**  
Straight, Titanium

Catalog #	Size, Jaw Length
PRO-04-084-10 T	45 mm, 10 mm
PRO-04-084-14 T	50 mm, 14 mm
PRO-04-084-20 T	60 mm, 20mm

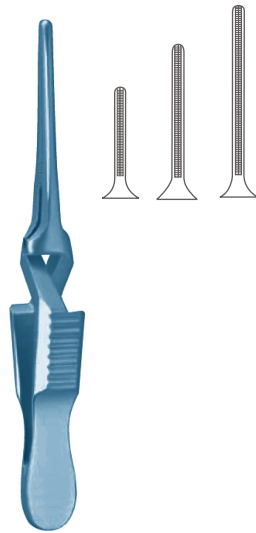

**DeBakey-Diethrich Atrauma Bulldog Clamp**  
Angled

Catalog #	Size, Jaw Length
PRO-04-085-10	35 mm, 10 mm
PRO-04-085-14	45 mm, 14 mm
PRO-04-085-20	50 mm, 20 mm

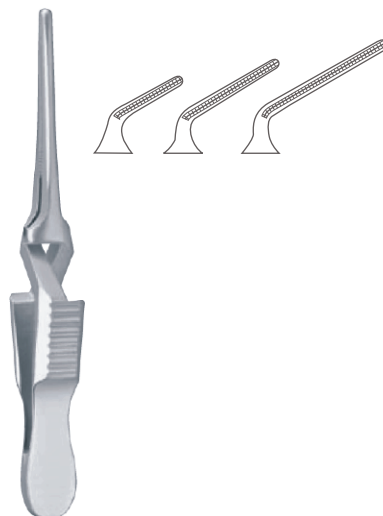

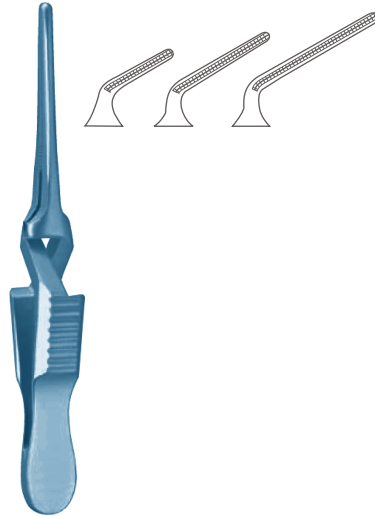

**DeBakey-Diethrich Atrauma Bulldog Clamp**  
Angled, Titanium

Catalog #	Size, Jaw Length
PRO-04-085-10 T	35 mm, 10 mm
PRO-04-085-14 T	45 mm, 14 mm
PRO-04-085-20 T	50 mm, 20mm



**DeBakey-Hess Bulldog Clamp**

Catalog #	Size, Jaw Length
PRO-04-089-35	35 mm, 10 mm
PRO-04-089-40	40 mm, 10 mm

**Mini-Glover Vena Atrauma Bulldog Clamp**  
Straight, Titanium

Catalog #	Size, Jaw Length
PRO-04-090-30 T	30 mm, 9 mm
PRO-04-090-35 T	35 mm, 13 mm
PRO-04-090-40 T	40 mm, 14 mm
PRO-04-090-50 T	50 mm, 23 mm

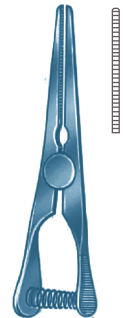

**Mini-Glover Vena Atrauma Bulldog Clamp**  
Gently Curved, Titanium

Catalog #	Size, Jaw Length
PRO-04-091-30 T	30 mm, 9 mm
PRO-04-091-35 T	35 mm, 13 mm
PRO-04-091-40 T	40 mm, 14 mm
PRO-04-091-50 T	50 mm, 23 mm

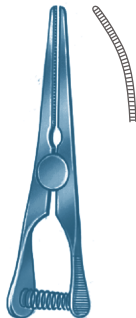

**Mini-Glover Vena Atrauma Bulldog Clamp**  
Strongly Curved, Titanium

Catalog #	Size, Jaw Length
PRO-04-093-30 T	30 mm, 9 mm
PRO-04-093-35 T	35 mm, 13 mm
PRO-04-093-40 T	40 mm, 14 mm
PRO-04-093-50 T	50 mm, 23 mm

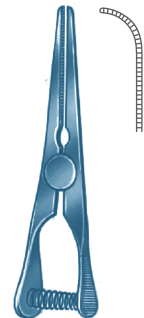



**Mini-Glover Arteria Atrauma Bulldog Clamp**  
Straight, Titanium

Catalog #	Size, Jaw Length
PRO-04-096-30 T	30 mm, 9 mm
PRO-04-096-35 T	35 mm, 13 mm
PRO-04-096-40 T	40 mm, 14 mm
PRO-04-096-50 T	50 mm, 23 mm

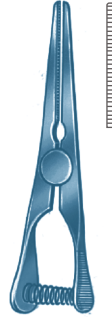

**Mini-Glover Arteria Atrauma Bulldog Clamp**  
Gently Curved, Titanium

Catalog #	Size, Jaw Length
PRO-04-097-30 T	30 mm, 9 mm
PRO-04-097-35 T	35 mm, 13 mm
PRO-04-097-40 T	40 mm, 14 mm
PRO-04-097-50 T	50 mm, 22 mm

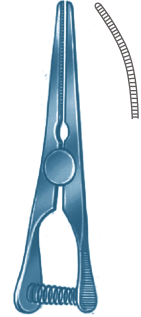

**Mini-Glover Arteria Atrauma Bulldog Clamp**  
Strongly Curved, Titanium

Catalog #	Size, Jaw Length
PRO-04-099-30 T	30 mm, 10mm
PRO-04-099-35 T	35 mm, 14 mm
PRO-04-099-40 T	40 mm, 15 mm
PRO-04-099-50 T	50 mm, 21mm

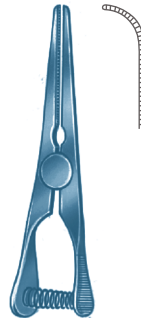

**Pean Haemostatic Forcep**

Catalog #	Size
PRO-04-110-14	14.5 cm (5 ¾")
PRO-04-110-16	16 cm (6 ¼")



**Korenlein Haemostatic Forcep**

Catalog #	Size
PRO-04-112-13	13 cm (5")



**Spencer-Wells Haemostatic Forcep**  
Straight

Catalog #	Size
PRO-04-114-13	13 cm (5")
PRO-04-114-14	14.5 cm (5 ¾")
PRO-04-114-15	15.5 cm (6")
PRO-04-114-18	18.5 cm (7 ¼")
PRO-04-114-20	20 cm (8")



**Spencer-Wells Haemostatic Forcep**  
Curved

Catalog #	Size
PRO-04-115-13	13 cm (5")
PRO-04-115-14	14 cm (5 ¾")
PRO-04-115-15	15 cm (6")
PRO-04-115-18	18 cm (7 ¼")
PRO-04-115-20	20 cm (8")





**Chaput Haemostatic Forcep**  
2 x 3 Teeth

Catalog #	Size
PRO-04-120-13	12.5 cm (5")

**Tuffier Haemostatic Forcep**  
4 x 5 Teeth

Catalog #	Size
PRO-04-122-13	12.5 cm (5")



**Atrauma Organ Grasping / Haemorrhoidal Forcep**

Catalog #	Size
PRO-04-126-25	25 cm (9 3/4")
PRO-04-126-26	26 cm (10 1/4")



**Collin Organ Grasping Forcep**

Catalog #	Size
PRO-04-128-14	14 cm (5 1/2")



**Collin Tumor Grasping Forcep**

Catalog #	Size
PRO-04-130-17	17 cm (6 ¾")



**Pennington Organ Grasping Forcep**

Catalog #	Size
PRO-04-134-15	15.5 cm (6")
PRO-04-134-20	21 cm (8 ¼")



**Pratt Haemostatic Forcep**

Catalog #	Size
PRO-04-136-15	15 cm (6")



**Martel-Rees Face-Lift Forcep**

Catalog #	Size
PRO-04-138-14	13.5 cm (5 ¼")



**Hartmann Haemostatic Forcep**  
Straight

Catalog #	Size
PRO-04-140-10	10 cm (4")



**Hartmann Haemostatic Forcep**  
Curved

Catalog #	Size
PRO-04-141-10	9.5 cm (3 ¾")



**Hartmann Haemostatic Forcep**  
Straight, 1 x 2 Teeth

Catalog #	Size
PRO-04-142-10	10 cm (4")



**Hartmann Haemostatic Forcep**  
Curved, 1 x 2 Teeth

Catalog #	Size
PRO-04-143-10	9.5 cm (3 ¾")



**Haemostatic Forcep**  
Cross Serrated Jaw

Catalog #	Size
PRO-04-146-12	12.5 cm (5")



**Carrel Haemostatic Forcep**

Catalog #	Size
PRO-04-148-08	8.5 cm (3 ¼")



**Terrier Haemostatic Forcep**  
1 x 2 Teeth

Catalog #	Size
PRO-04-150-08	8.5 cm (3 ¼")



**Halsted-Mosquito Haemostatic Forcep**  
Straight

Catalog #	Size
PRO-04-160-12	12.5 cm (4 ¾")
PRO-04-160-14	14.5 cm (5 ½")



**Halsted-Mosquito Haemostatic Forcep**  
Curved

Catalog #	Size
PRO-04-161-12	12 cm (4 ¾")
PRO-04-161-14	14 cm (5 ½")





**Halsted-Mosquito Haemostatic Forcep**  
Straight, 1 x 2 Teeth

Catalog #	Size
PRO-04-162-12	12.5 cm (4 ¾")
PRO-04-162-14	14.5 cm (5 ¾")

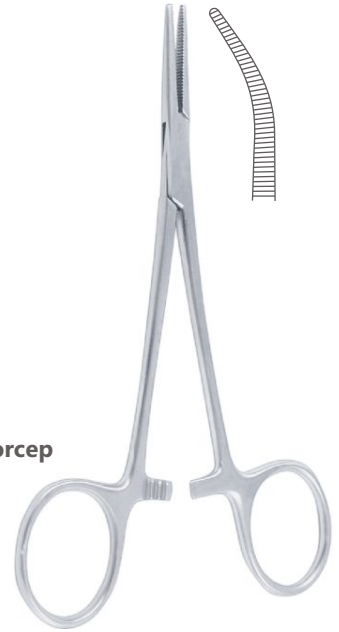

**Halsted-Mosquito Haemostatic Forcep**  
Curved, 1 x 2 Teeth

Catalog #	Size
PRO-04-163-12	12 cm (4 ¾")
PRO-04-163-14	14 cm (5 ½")



**Micro-Mosquito Haemostatic Forcep**  
Straight

Catalog #	Size
PRO-04-170-10	10 cm (4")
PRO-04-170-12	12 cm (4 ¾")



**Micro-Mosquito Haemostatic Forcep**  
Curved

Catalog #	Size
PRO-04-171-10	9.5 cm (3 ¾")
PRO-04-171-12	11.5 cm (4 ½")

**Micro-Mosquito Haemostatic Forcep**  
Straight, 1 x 2 Teeth

Catalog #	Size
PRO-04-172-10	10 cm (4")
PRO-04-172-12	12 cm (4 ¾")



**Micro-Mosquito Haemostatic Forcep**  
Curved, 1 x 2 Teeth

Catalog #	Size
PRO-04-173-10	10 cm (4")
PRO-04-173-12	12 cm (4 ¾")



**Halsted-Mosquito Haemostatic Forcep**  
Straight

Catalog #	Size
PRO-04-176-18	18.5 cm (7 ¼")
PRO-04-176-21	21 cm (8 ¼")



**Halsted-Mosquito Haemostatic Forcep**  
Curved

Catalog #	Size
PRO-04-177-18	18 cm (7")
PRO-04-177-21	20.5 cm (8")

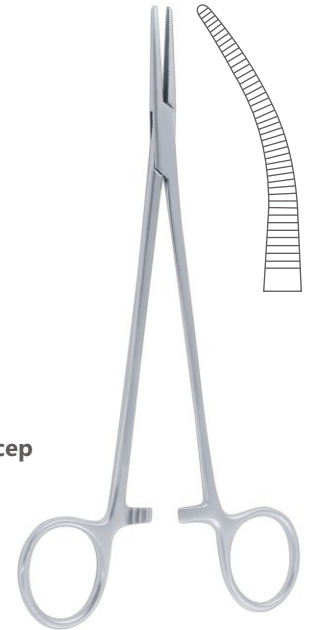



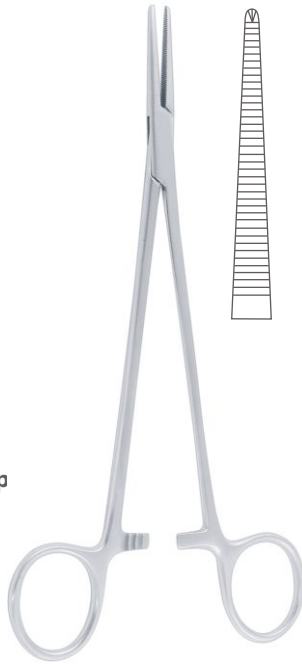

**Halsted-Mosquito Haemostatic Forcep**  
Straight, 1 x 2 Teeth

Catalog #	Size
PRO-04-178-18	18.5 cm (7 ¼")
PRO-04-178-21	21 cm (8 ¼")

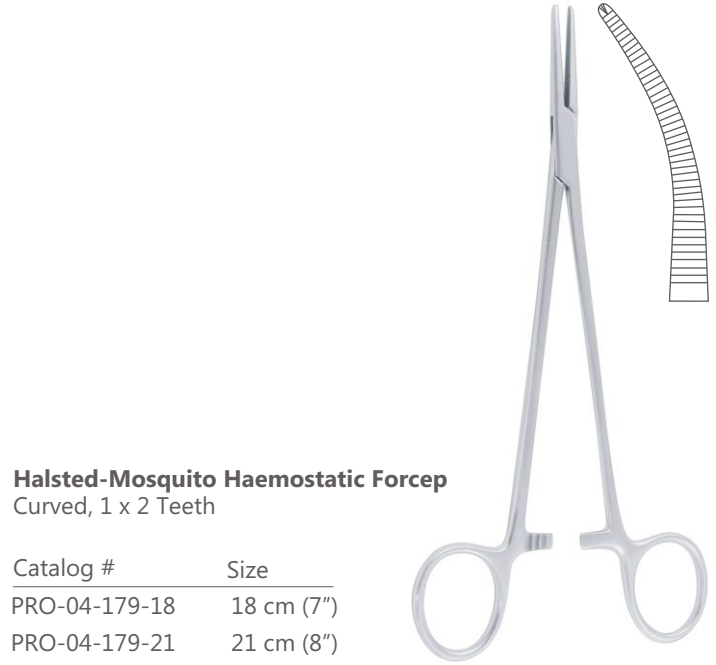

**Halsted-Mosquito Haemostatic Forcep**  
Curved, 1 x 2 Teeth

Catalog #	Size
PRO-04-179-18	18 cm (7")
PRO-04-179-21	21 cm (8")



**Providence-Hospital Haemostatic Forcep**  
Straight

Catalog #	Size
PRO-04-182-14	14 cm (5 ½")



**Providence-Hospital Haemostatic Forcep**  
Curved

Catalog #	Size
PRO-04-183-14	14 cm (5 ½")



**Leriche Haemostatic Forcep**  
Straight

Catalog #	Size
PRO-04-184-15	15.5 cm (6")

**Leriche Haemostatic Forcep**  
Curved

Catalog #	Size
PRO-04-185-15	15 cm (6")



**Leriche Haemostatic Forcep**  
Straight, 1 x 2 Teeth

Catalog #	Size
PRO-04-186-15	15.5 cm (6")

**Leriche Haemostatic Forcep**  
Curved, 1 x 2 Teeth

Catalog #	Size
PRO-04-187-15	15 cm (6")



**Kelly Haemostatic Forcep**  
Straight

Catalog #	Size
PRO-04-200-14	14.5 cm (5 ¾")



**Kelly Haemostatic Forcep**  
Curved

Catalog #	Size
PRO-04-201-14	14 cm (5 ½")



**Kelly-Rankin Haemostatic Forcep**  
Straight

Catalog #	Size
PRO-04-202-16	16 cm (6 ¼")



**Kelly-Rankin Haemostatic Forcep**  
Curved

Catalog #	Size
PRO-04-203-16	15.5 cm (6")





**Crile Haemostatic Forcep**  
Straight

Catalog #	Size
PRO-04-210-14	14.5 cm (5 ¾")



**Crile Haemostatic Forcep**  
Curved

Catalog #	Size
PRO-04-211-14	14 cm (5 ½")



**Crile Haemostatic Forcep**  
Straight, 1 x 2 Teeth

Catalog #	Size
PRO-04-212-14	14 cm (5 ½")



**Crile Haemostatic Forcep**  
Curved, 1 x 2 Teeth

Catalog #	Size
PRO-04-213-14	14 cm (5 ½")



**Crile-Rankin Haemostatic Forcep**  
Straight

Catalog #	Size
PRO-04-214-16	17 cm (6 ¾")

**Crile-Rankin Haemostatic Forcep**  
Curved

Catalog #	Size
PRO-04-215-16	17 cm (6 ¾")



**Rochester-Pean Haemostatic Forcep**  
Straight

Catalog #	Size
PRO-04-220-14	14.5 cm (5 ¾")
PRO-04-220-16	16.5 cm (6 ½")
PRO-04-220-18	18.5 cm (7 ¼")
PRO-04-220-20	20.5 cm (8")
PRO-04-220-22	22.5 cm (8 ¾")
PRO-04-220-24	24.5 cm (9 ¾")
PRO-04-220-26	26 cm (10 ¼")
PRO-04-220-30	30.5 cm (12")

**Rochester-Pean Haemostatic Forcep**  
Curved

Catalog #	Size
PRO-04-221-14	14 cm (5 ½")
PRO-04-221-16	16 cm (6 ¼")
PRO-04-221-18	18 cm (7")
PRO-04-221-20	20 cm (8")
PRO-04-221-22	22 cm (8 ¾")
PRO-04-221-24	24 cm (9 ½")
PRO-04-221-26	25.5 cm (10")
PRO-04-221-30	30 cm (11 ¾")



**Ochsner-Kocher Haemostatic Forcep**  
Straight, 1 x 2 Teeth

Catalog #	Size
PRO-04-230-14	14.5 cm (5 ¾")
PRO-04-230-16	16.5 cm (6 ½")
PRO-04-230-18	18.5 cm (7 ¼")
PRO-04-230-20	20.5 cm (8")
PRO-04-230-22	22.5 cm (8 ¾")
PRO-04-230-24	24.5 cm (9 ¾")
PRO-04-230-26	26 cm (10 ¼")
PRO-04-230-30	30.5 cm (12")



**Ochsner-Kocher Haemostatic Forcep**  
Curved, 1 x 2 Teeth

Catalog #	Size
PRO-04-231-14	14 cm (5 ½")
PRO-04-231-16	16 cm (6 ¼")
PRO-04-231-18	18 cm (7")
PRO-04-231-20	20 cm (8")
PRO-04-231-22	22 cm (8 ¾")
PRO-04-231-24	24 cm (9 ½")
PRO-04-231-26	25.5 cm (10 ")
PRO-04-231-30	30 cm (11 ¾")



**Rochester-Ochsner Haemostatic Forcep**  
Straight

Catalog #	Size
PRO-04-234-14	14 cm (5 ½")



**Rochester-Ochsner Haemostatic Forcep**  
Curved

Catalog #	Size
PRO-04-235-14	14 cm (5 ½")



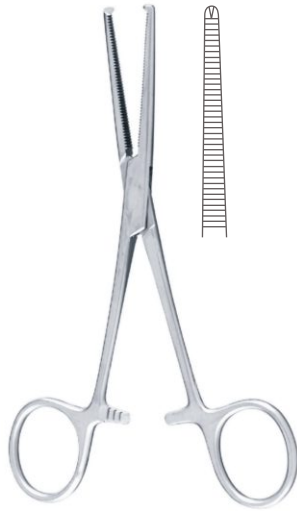

**Kocher Haemostatic Forcep**  
Straight, 1 x 2 Teeth

Catalog #	Size
PRO-04-236-15	15 cm (6")

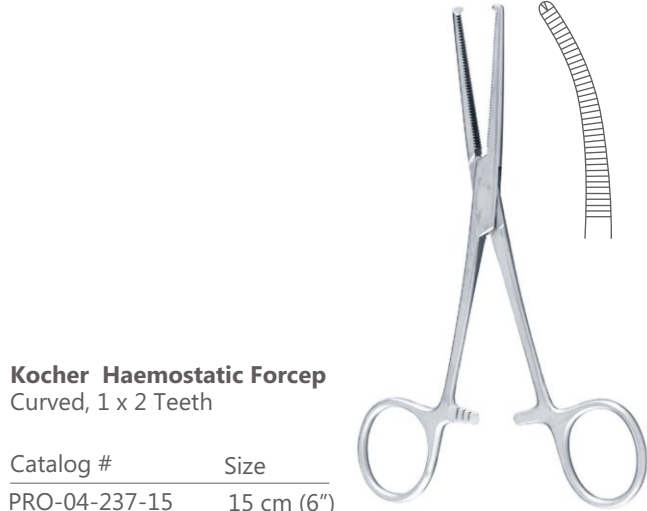

**Kocher Haemostatic Forcep**  
Curved, 1 x 2 Teeth

Catalog #	Size
PRO-04-237-15	15 cm (6")



**Pean-Nippon Haemostatic Forcep**  
Straight

Catalog #	Size
PRO-04-240-14	14.5 cm (5 ¾")
PRO-04-240-16	16.5 cm (6 ½")
PRO-04-240-18	18.5 cm (7 ¼")

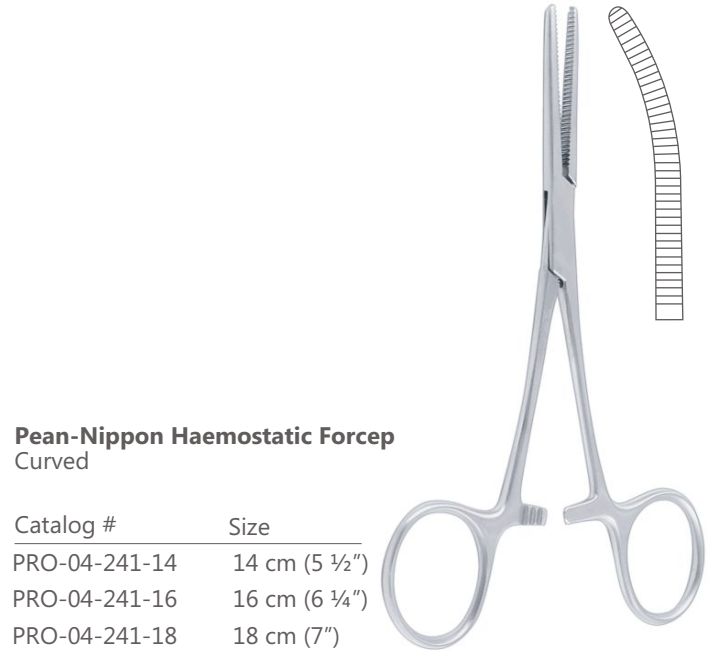

**Pean-Nippon Haemostatic Forcep**  
Curved

Catalog #	Size
PRO-04-241-14	14 cm (5 ½")
PRO-04-241-16	16 cm (6 ¼")
PRO-04-241-18	18 cm (7")

**Kocher-Nippon Haemostatic Forcep**  
Straight, 1 x 2 Teeth

Catalog #	Size
PRO-04-242-14	14.5 cm (5 ¾")
PRO-04-242-16	16.5 cm (6 ½")
PRO-04-242-18	18.5 cm (7 ¼")



**Kocher-Nippon Haemostatic Forcep**  
Curved, 1 x 2 Teeth

Catalog #	Size
PRO-04-243-14	14.5 cm (5 ¾")
PRO-04-243-16	16 cm (6 ¼")
PRO-04-243-18	18 cm (7")



**Pean (Delicate) Haemostatic Forcep**  
Straight

Catalog #	Size
PRO-04-246-13	13.5 cm (5 ¼")
PRO-04-246-14	14.5 cm (5 ¾")
PRO-04-246-16	17 cm (6 ¾")



**Pean (Delicate) Haemostatic Forcep**  
Curved

Catalog #	Size
PRO-04-247-13	13 cm (5")
PRO-04-247-14	14 cm (5 ½")
PRO-04-247-16	16.5 cm (6 ½")







**Kocher (Delicate) Haemostatic Forcep**  
Straight, 1 x 2 Teeth

Catalog #	Size
PRO-04-248-13	13 cm (5")
PRO-04-248-14	14 cm (5 ½")
PRO-04-248-17	16 cm (6 ¼")

**Kocher (Delicate) Haemostatic Forcep**  
Curved, 1 x 2 Teeth

Catalog #	Size
PRO-04-249-13	13 cm (5")
PRO-04-249-14	14 cm (5 ½")
PRO-04-249-16	16 cm (6 ¼")

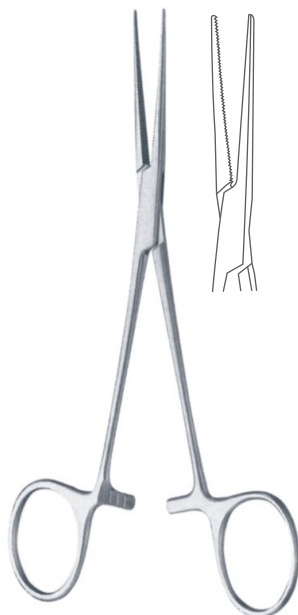

**Coller Haemostatic Forcep**  
Straight

Catalog #	Size
PRO-04-260-14	14 cm (5 ½")
PRO-04-260-16	16.5 cm (6 ½")
PRO-04-260-18	18.5 cm (7 ¼")

**Coller Haemostatic Forcep**  
Curved

Catalog #	Size
PRO-04-261-14	14 cm (5 ½")
PRO-04-261-16	16.5 cm (6 ½")
PRO-04-261-18	18.5 cm (7 ¼")

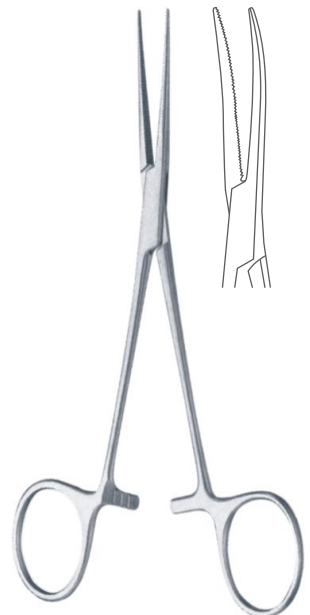



**Fraser-Kelly (Crile) Haemostatic Forcep**  
Curved

Catalog #	Size
PRO-04-265-18	18 cm (7")

**Adson Haemostatic Forcep**  
Straight

Catalog #	Size
PRO-04-268-18	19 cm (7 ½")

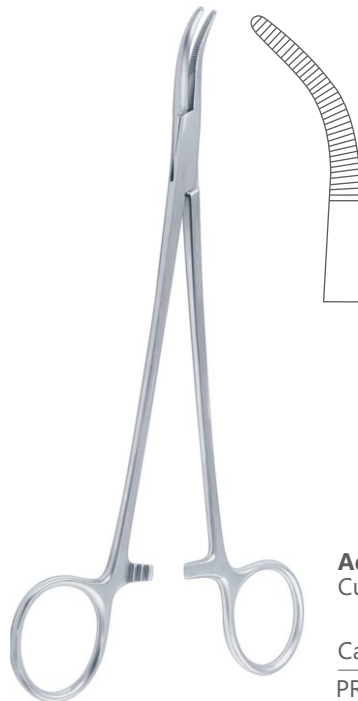
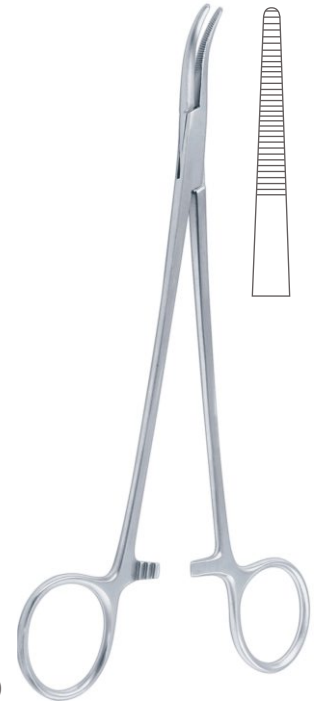

**Adson Haemostatic Forcep**  
Curved

Catalog #	Size
PRO-04-269-18	18.5 cm (7 ¼")

**Adson Haemostatic Forcep**  
Curved

Catalog #	Size
PRO-04-271-21	21.5 cm (8 ½")





**Jacobson Haemostatic Forcep**  
Curved

Catalog #	Size
PRO-04-275-19	19 cm (7 ½")

**Dunhill Haemostatic Forcep**  
Gently Curved

Catalog #	Size
PRO-04-277-19	19 cm (7 ½")



**Grey-Turner Haemostatic Forcep**  
Curved

Catalog #	Size
PRO-04-279-19	18 cm (7")

**Dandy-Mosquito Haemostatic Forcep**  
Laterally Curved, Cross Serrated

Catalog #	Size
PRO-04-281-12	12 cm (4 ¾")





**Dandy Haemostatic Forcep**  
Laterally Curved

Catalog #	Size
PRO-04-283-14	14.5 cm (5 ¾")

**Dandy Haemostatic Forcep**  
Laterally Curved, 1 x 2 Teeth

Catalog #	Size
PRO-04-285-14	14.5 cm (5 ¾")

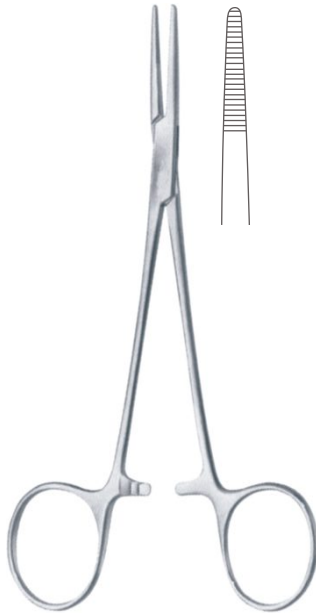
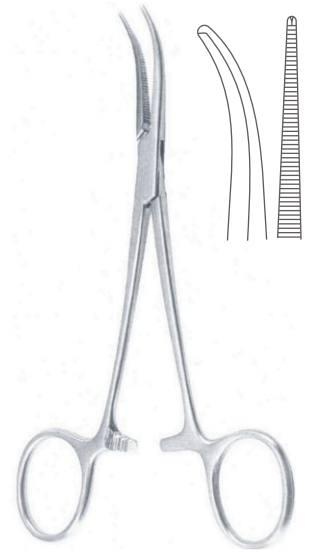

**Cairns Haemostatic Forcep**  
Straight

Catalog #	Size
PRO-04-290-15	15 cm (6")

**Cairns Haemostatic Forcep**  
Curved

Catalog #	Size
PRO-04-291-15	15 cm (6")





**Cairns Haemostatic Forcep**  
Curved to Side

Catalog #	Size
PRO-04-293-14	14.5 cm (5 ¾")

**Dunhill Haemostatic Forcep**  
Straight

Catalog #	Size
PRO-04-295-13	13 cm (5")



**Lovelace Haemostatic Forcep**  
Straight, Cross Serrated

Catalog #	Size
PRO-04-300-16	16 cm (6 ¼")

**Lovelace Haemostatic Forcep**  
Straight, Cross Serrated, 1 x 2 Teeth

Catalog #	Size
PRO-04-302-16	16 cm (6 ¼")





**Martin-Fuchsig Haemostatic Forcep**  
Curved

Catalog #	Size
PRO-04-305-20	20.5 cm (8")



**Nissen Haemostatic Forcep**  
Curved

Catalog #	Size
PRO-04-307-18	18.5 cm (7 ¼")



**Schnidt Tonsil Haemostatic Forcep**  
Strongly Curved

Catalog #	Size
PRO-04-311-01	18.5 cm (7 ¼")

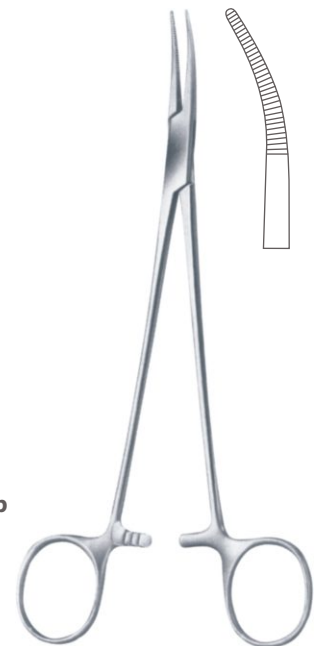

**Schnidt Tonsil Haemostatic Forcep**  
Gently Curved

Catalog #	Size
PRO-04-311-02	19 cm (7 ½")



**Negus Haemostatic Forcep**  
Fig. 1

Catalog #	Size
PRO-04-315-01	19.5 cm (7 ¾")

**Negus Haemostatic Forcep**  
Fig. 2

Catalog #	Size
PRO-04-315-02	20 cm (8")



**Wilson Haemostatic Forcep**  
Curved

Catalog #	Size
PRO-04-317-19	19 cm (7 ½")

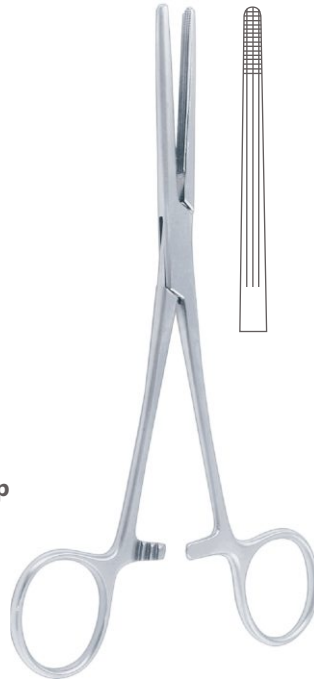

**Rochester-Carmalt Haemostatic Forcep**  
Straight

Catalog #	Size
PRO-04-320-16	17 cm (6 ¾")
PRO-04-320-20	20.5 cm (8")



**Rochester-Carmalt Haemostatic Forcep**  
Curved

Catalog #	Size
PRO-04-321-16	16.5 cm (6 ½")
PRO-04-321-20	20 cm (8")





**Fickling Haemostatic Forcep**

Catalog #	Size
PRO-04-331-18	18 cm (7")

**Fickling Haemostatic Forcep**  
1 x 2 Teeth

Catalog #	Size
PRO-04-333-18	18 cm (7")



**Bainbridge Haemostatic Forcep**  
Straight, Longitudinally Serrated

Catalog #	Size
PRO-04-340-15	15 cm (6")
PRO-04-340-18	18.5 cm (7 ¼")

**Bainbridge Haemostatic Forcep**  
Curved, Longitudinally Serrated

Catalog #	Size
PRO-04-341-15	15 cm (6")
PRO-04-341-18	18.5 cm (7 ¼")

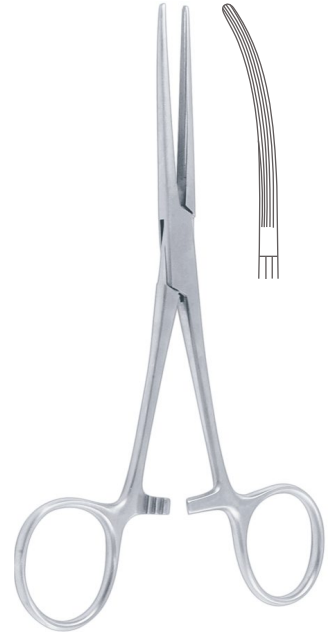



**Birkett Haemostatic Forcep**  
Straight

Catalog #	Size
PRO-04-346-18	18.5 cm (7 ¼")

**Birkett Haemostatic Forcep**  
Curved

Catalog #	Size
PRO-04-347-18	18.5 cm (7 ¼")

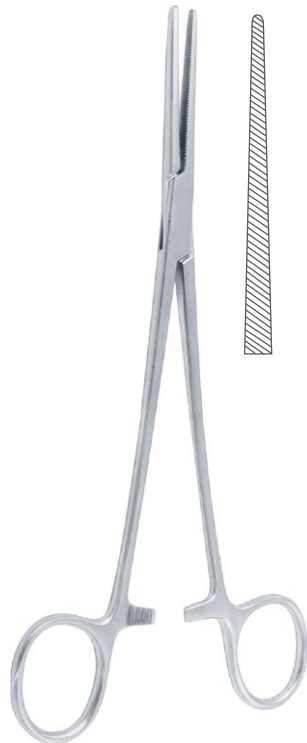

**Bengolea Haemostatic Forcep**  
Straight

Catalog #	Size
PRO-04-350-20	21.5 cm (8 ½")
PRO-04-350-26	26 cm (10 ¼")



**Bengolea Haemostatic Forcep**  
Curved

Catalog #	Size
PRO-04-351-20	21 cm (8 ¼")
PRO-04-351-26	25.5 cm (10")

**Bengolea Haemostatic Forcep**  
Straight, 1 x 2 Teeth

Catalog #	Size
PRO-04-352-20	21.5 cm (8 ½")
PRO-04-352-26	26 cm (10 ¼")

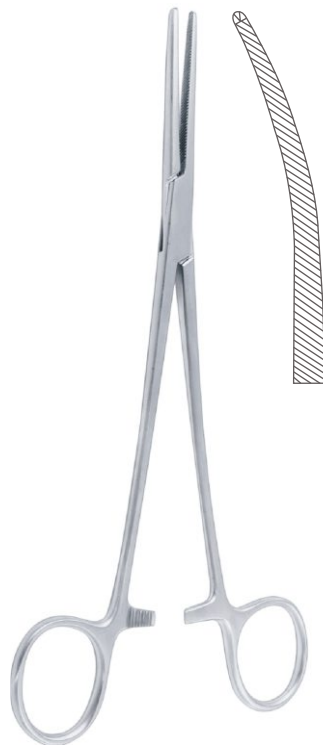

**Bengolea Haemostatic Forcep**  
Curved, 1 x 2 Teeth

Catalog #	Size
PRO-04-353-20	21 cm (8 ¼")
PRO-04-353-26	25.5 cm (10")



**Roberts Haemostatic Forcep**  
Straight

Catalog #	Size
PRO-04-360-22	22.5 cm (8 ¾")

**Roberts Haemostatic Forcep**  
Curved

Catalog #	Size
PRO-04-361-22	21.5 cm (8 ½")



**Sarot Haemostatic Forcep**  
Straight

Catalog #	Size
PRO-04-364-24	25 cm (9 ¾")

**Sarot Haemostatic Forcep**  
Curved

Catalog #	Size
PRO-04-365-24	24.5 cm (9 ¾")





**Crafoord Haemostatic Forcep**  
Curved

Catalog #	Size
PRO-04-371-18	18 cm (9 3/4")
PRO-04-371-24	24.5 cm (9 3/4")



**Crafoord- Sellors Haemostatic Forcep**

Catalog #	Size, Profile
PRO-04-375-01	24 cm (9 1/2"), Fig. 1
PRO-04-375-02	24 cm (9 1/2"), Fig. 2
PRO-04-375-03	24 cm (9 1/2"), Fig. 3



**Bridge Haemostatic Forcep**  
Straight

Catalog #	Size
PRO-04-380-27	27.5 cm (10 ¾")



**Bridge Haemostatic Forcep**  
Curved

Catalog #	Size
PRO-04-381-27	27.5 cm (10 ¾")

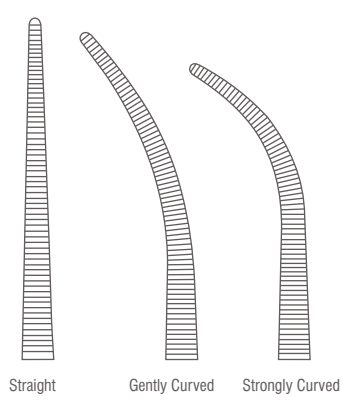
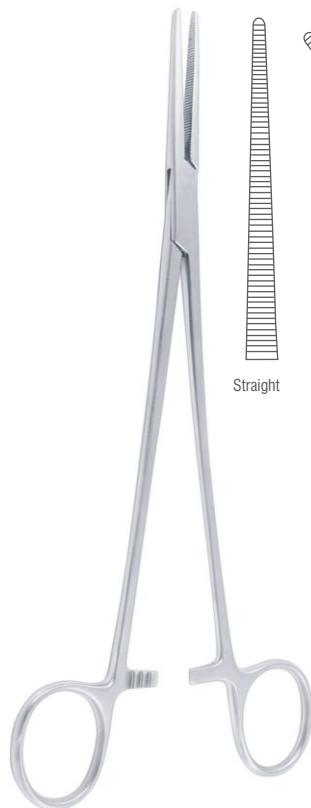

**Heiss Haemostatic Forcep**

Catalog #	Size, Profile
PRO-04-386-20	21 cm (8 ¼"), Straight
PRO-04-387-20	20.5 cm (8"), Gently Curved
PRO-04-389-20	20 cm (8"), Strongly Curved

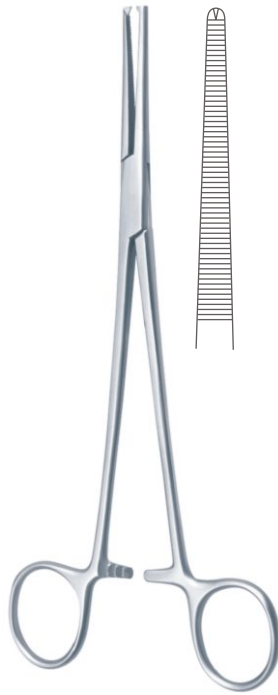

**Heiss Haemostatic Forcep**  
Straight, 1 x 2 Teeth

Catalog #	Size
PRO-04-390-20	20 cm (8")

**Heiss Haemostatic Forcep**  
Curved, 1 x 2 Teeth

Catalog #	Size
PRO-04-391-20	20 cm (8")

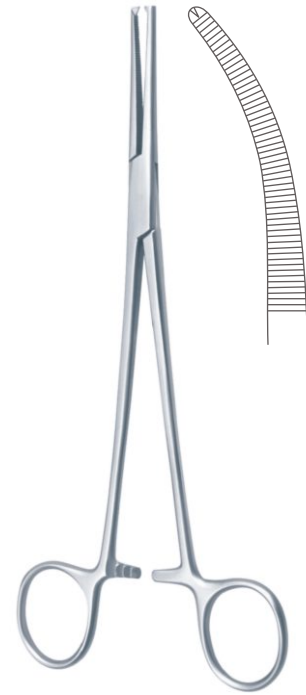

**Overholt-Martin Dissecting and Ligature Forcep**

Catalog #	Size
PRO-04-401-01	18.5 cm (7 ¼"), Fig. 1
PRO-04-401-02	20.5 cm (8"), Fig. 2
PRO-04-401-03	21 cm (8 ¼"), Fig. 3
PRO-04-401-04	21.5 cm (8 ½"), Fig. 4
PRO-04-401-05	24.5 cm (9 ¾"), Fig. 5

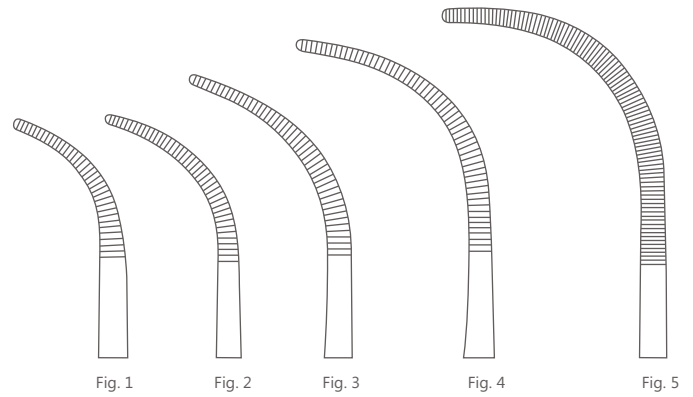



**Dissecting and Ligature Forcep**  
Smooth Jaws

Catalog #	Size
PRO-04-404-12	12.5 cm (5")



**Adson-Baby Dissecting and Ligature Forcep**  
Curved

Catalog #	Size
PRO-04-411-14	14.5 cm (5 ¾")
PRO-04-411-18	18 cm (7")





**Overholt-Baby Dissecting and Ligature Forcep**  
Curved

Catalog #	Size
PRO-04-415-14	14 cm (5 ½")



**Overholt-Mixter Dissecting and Ligature Forcep**  
Curved

Catalog #	Size
PRO-04-417-21	21.5 cm (8 ½")



**Overholt-Geissendoerfer Dissecting and Ligature Forcep**

Catalog #	Size
PRO-04-421-01	20.5 cm (8"), Fig. 1
PRO-04-421-02	20 cm (8"), Fig. 2
PRO-04-421-03	21.5 cm (8 ½"), Fig. 3
PRO-04-421-04	22 cm (8 ¾"), Fig. 4
PRO-04-421-05	21.5 cm (8 ½"), Fig. 5
PRO-04-421-06	22 cm (8 ¾"), Fig. 6
PRO-04-421-07	22 cm (8 ¾"), Fig. 7

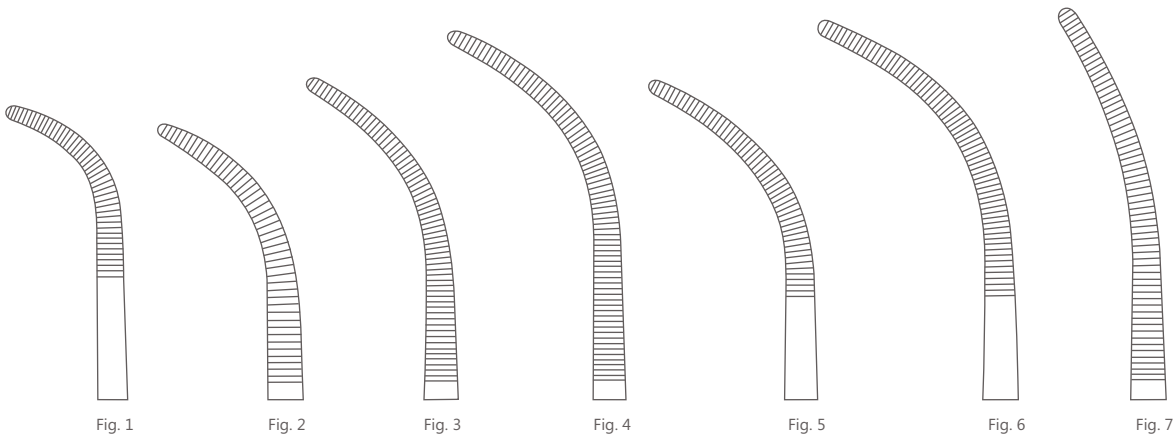



**Overholt-Geissendoerfer Dissecting and Ligature Forcep**

Catalog #	Size
PRO-04-423-01	27 cm (10 ¾"), Fig. 1
PRO-04-423-02	26.5 cm (10 ½"), Fig. 2
PRO-04-423-03	27.5 cm (10 ¾"), Fig. 3
PRO-04-423-04	28 cm (11"), Fig. 4
PRO-04-423-05	27.5 cm (10 ¾"), Fig. 5
PRO-04-423-06	28 cm (11"), Fig. 6
PRO-04-423-07	27.5 cm (10 ¾"), Fig. 7

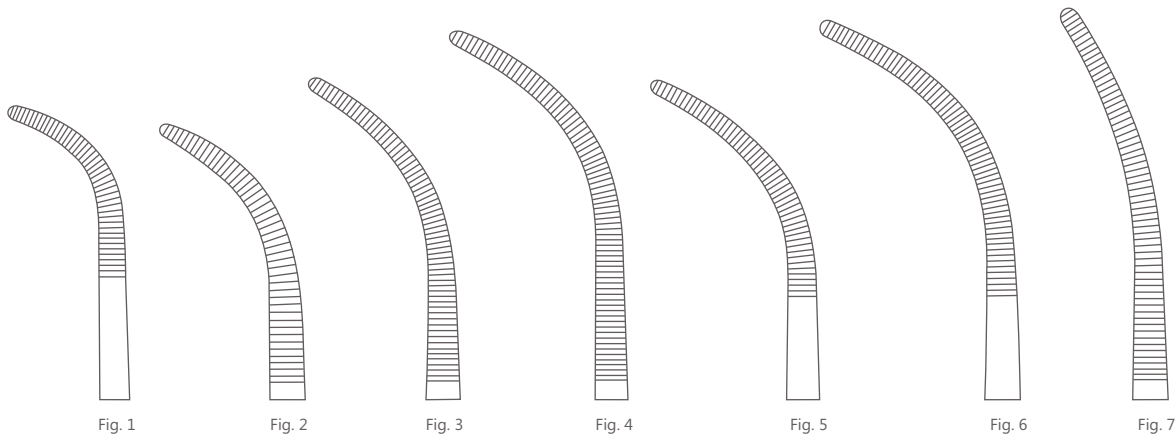

**Overholt-Fine Dissecting and Ligature Forcep**  
Curved

Catalog #	Size
PRO-04-427-00	21.5 cm (8 1/2")
PRO-04-427-01	21 cm (8 1/4")
PRO-04-427-02	22 cm (8 3/4")
PRO-04-427-03	23 cm (9")
PRO-04-427-06	22.5 cm (8 3/4")

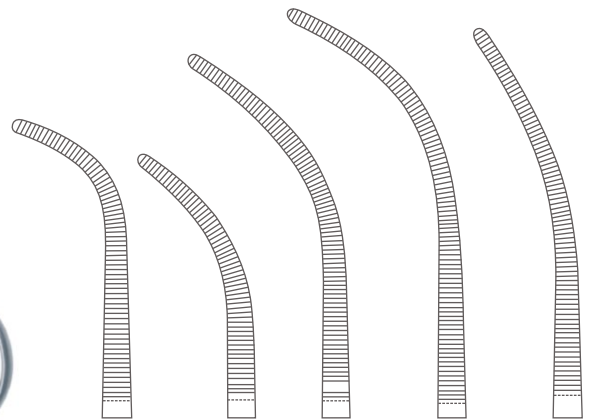

**Overholt Dissecting and Ligature Forcep**  
Curved

Catalog #	Size
PRO-04-429-00	29.5 cm (11 1/2")
PRO-04-429-01	29.5 cm (11 1/2")
PRO-04-429-06	30 cm (11 3/4")

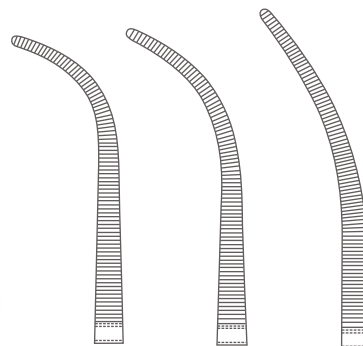

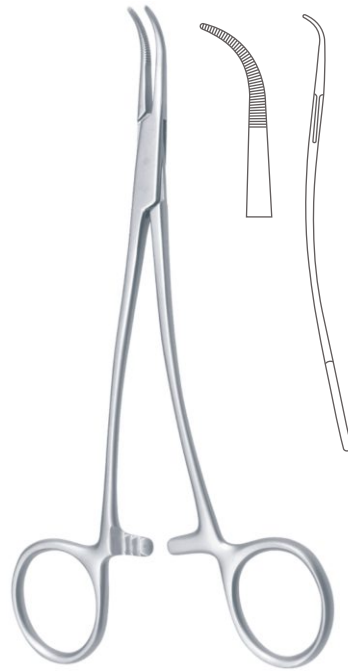

**Overholt-Mini Dissecting and Ligature Forcep**  
Curve, S Shaped

Catalog #	Size
PRO-04-431-15	15 cm (6")



**Overholt-Mini Dissecting and Ligature Forcep**  
Curve

Catalog #	Size
PRO-04-433-20	20 cm (8")



**Kelly Dissecting and Ligature Forcep**  
Fig. 1

Catalog #	Size
PRO-04-441-19	19.5 cm (7 ¾")
PRO-04-441-22	22.5 cm (8 ¾")
PRO-04-441-24	24.5 cm (9 ¾")



**Kelly Dissecting and Ligature Forcep**  
Fig. 2

Catalog #	Size
PRO-04-443-19	19 cm (7 ½")
PRO-04-443-22	22 cm (8 ¾")
PRO-04-443-24	24 cm (9 ½")



**Kelly Dissecting and Ligature Forcep**  
Fig. 3

Catalog #	Size
PRO-04-445-19	18.5 cm (7 ¼")
PRO-04-445-22	21.5 cm (8 ½")
PRO-04-445-24	23.5 cm (9 ¼")



**Lawrence Dissecting and Ligature Forcep**  
Curved

Catalog #	Size
PRO-04-451-28	28 cm (11")

**Meeker Dissecting and Ligature Forcep**  
Right Angled

Catalog #	Size
PRO-04-455-28	28 cm (11")





**Mini-Gemini Dissecting and Ligature Forcep**  
Curved

Catalog #	Size
PRO-04-469-18	18 cm (7")
PRO-04-469-22	22.5cm (8 ¾")
PRO-04-469-25	25 cm (9 ¾")
PRO-04-469-28	28.5 cm (11 ¼")



**Gemini Dissecting and Ligature Forcep**  
Curved

Catalog #	Size
PRO-04-471-13	13 cm (5")
PRO-04-471-16	16 cm (6 ¼")
PRO-04-471-18	18 cm (7")
PRO-04-471-20	21 cm (8 ¼")
PRO-04-471-23	23 cm (9")
PRO-04-471-25	25 cm (9 ¾")
PRO-04-471-28	28 cm (11")





**Rumel Dissecting and Ligature Forcep**  
Curved

Catalog #	Size
PRO-04-475-01	24 cm (9 ½")
PRO-04-475-02	23.5 cm (9 ½")
PRO-04-475-03	23 cm (9")
PRO-04-475-04	24 cm (9 ½")
PRO-04-475-05	23.5 cm (9 ¼")



**Zenker Dissecting and Ligature Forcep**  
Curved

Catalog #	Size
PRO-04-479-01	29.5 cm (11 ½")
PRO-04-479-02	28.5 cm (11 ¼")

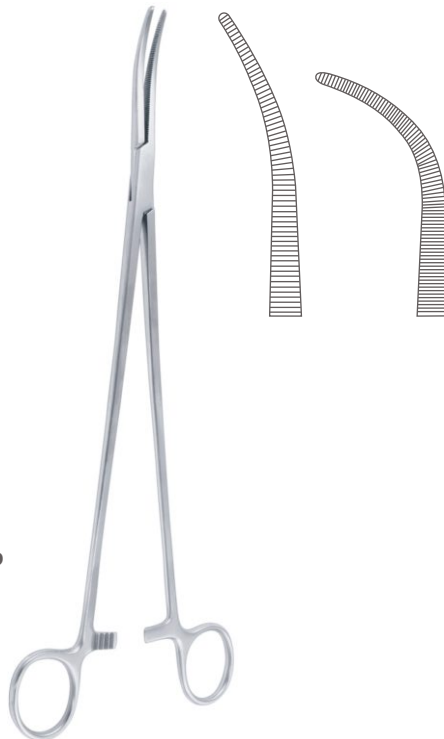



**Kieback Dissecting and Ligature Forcep**  
Curved

Catalog #	Size
PRO-04-481-23	23.5 cm (9 ¼")



**Mixer-Baby Dissecting and Ligature Forcep**  
Gently Curved

Catalog #	Size
PRO-04-491-01	13.5 cm (5 ¼")



**Mixer-Baby Dissecting and Ligature Forcep**  
Strongly Curved

Catalog #	Size
PRO-04-491-02	13 cm (5")



**Mixer-Baby Dissecting and Ligature Forcep**  
Curved

Catalog #	Size
PRO-04-493-14	13.5 cm (5 ¼")



**Mixer-Baby Dissecting and Ligature Forcep**  
Curved

Catalog #	Size
PRO-04-495-18	18.5 cm (7 ¼")



**Mixer Dissecting and Ligature Forcep**  
Right Angled

Catalog #	Size
PRO-04-497-15	16 cm (6 ¼")
PRO-04-497-19	18 cm (7")

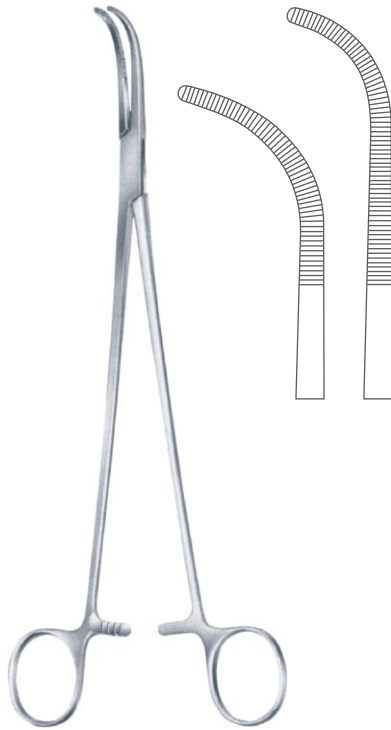

**Mixer Dissecting and Ligature Forcep**  
Curved

Catalog #	Size
PRO-04-499-22	22.5 cm (8 ¾")
PRO-04-499-23	23 cm (9")



**Mixer Dissecting and Ligature Forcep**  
Right Angled, Longitudinally Serrated

Catalog #	Size
PRO-04-501-22	22.5 cm (8 ¾")
PRO-04-501-25	26 cm (10 ¼")
PRO-04-501-28	28 cm (11")



**McQuigg-Mixer Dissecting and Ligature Forcep**  
Right Angled, Longitudinally Serrated

Catalog #	Size
PRO-04-505-22	23.5 cm (9 ¼")



**Mixer-O'Shaughnessy Dissecting and Ligature Forcep**  
Curved

Catalog #	Size
PRO-04-509-19	18.5 cm (7")



**O'Shaughnessy Dissecting and Ligature Forcep**  
Curved

Catalog #	Size
PRO-04-511-14	15 cm (6")
PRO-04-511-17	18 cm (7")
PRO-04-511-20	20 cm (8")
PRO-04-511-23	23 cm (9")
PRO-04-511-26	26 cm (10 ¼")

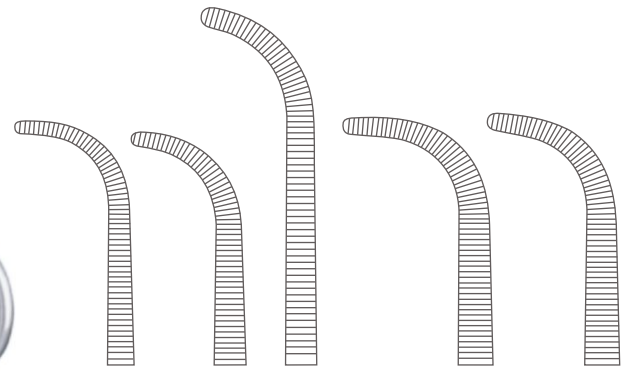

**Wickstroem Dissecting and Ligature Forcep**  
Right Angled

Catalog #	Size
PRO-04-517-21	21 cm (8 ¼")
PRO-04-517-24	24.5 cm (9 ¾")



**Lahey Dissecting and Ligature Forcep**  
Curved

Catalog #	Size
PRO-04-519-18	18.5 cm (7 ¼")





**Kantrowitz Dissecting and Ligature Forcep**  
Right Angled

Catalog #	Size
PRO-04-523-20	20 cm (8")
PRO-04-523-25	25 cm (9 ¾")
PRO-04-523-27	27.5 cm (10 ¾")



**Barre Dissecting and Ligature Forcep**  
Extra Delicate

Catalog #	Size
PRO-04-527-28	28 cm (11")



**Barre Dissecting and Ligature Forcep**  
Delicate

Catalog #	Size
PRO-04-529-28	28 cm (11")



**Lahey (Sweet) Bile Duct Clamp**  
Curved

Catalog #	Size
PRO-04-535-19	19.5 cm (7 ¾")





**Lahey Bile Duct Clamp**  
Angled

Catalog #	Size
PRO-04-537-23	22.5 cm (8 ¾")

**Lahey (Sweet) Bile Duct Clamp**  
Curved

Catalog #	Size
PRO-04-539-23	23 cm (9")



**Finochietto Dissecting and Ligature Forcep**  
Right Angled

Catalog #	Size
PRO-04-541-24	24 cm (9 ½")

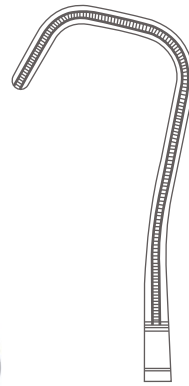

Fig. 1

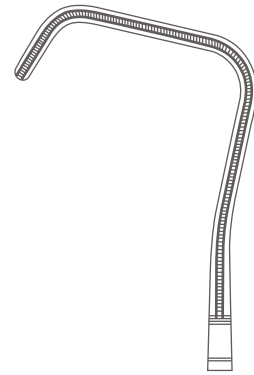
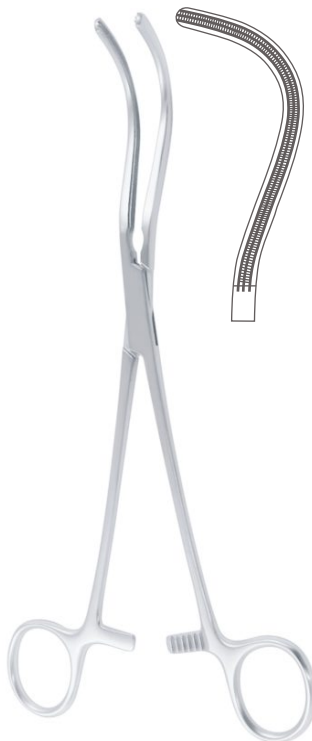

Fig. 2

**Uro-Tangential Atrauma Tangential Forcep**

Catalog #	Size, Profile
PRO-04-551-01	25 cm (9 ¾"), Fig. 1
PRO-04-551-02	27 cm (10 ¾"), Fig. 2



**Guyon Atrauma Kidney Pedicle Clamp Curved**

Catalog #	Size
PRO-04-561-23	23 cm (9")
PRO-04-561-24	24 cm (9 ½")

**Guyon Kidney Pedicle Clamp Curved**

Catalog #	Size
PRO-04-563-23	24 cm (9 ½")





**Guyon Kidney Pedicle Clamp**  
Curved

Catalog #	Size
PRO-04-565-20	19.5 cm (7 ¾")
PRO-04-565-22	21.5 cm (8 ½")
PRO-04-565-24	24 cm (9 ½")

**Stille Kidney Pedicle Clamp**  
Curved, Grooved

Catalog #	Size
PRO-04-569-23	23 cm (9")



**Herrick Kidney Pedicle Clamp**  
Double Angled, Longitudinally Serrated

Catalog #	Size
PRO-04-571-23	23 cm (9")

**Desjardins Bile Duct Clamp**  
Curved Downwards

Catalog #	Size
PRO-04-581-21	21 cm (8 ¼")





**Nissen Bile Duct Clamp**  
Curved Downwards

Catalog #	Size
PRO-04-583-21	21.5 cm (8 ½")

**Gray Dissecting and Ligature Forcep**  
Curved S Shaped

Catalog #	Size
PRO-04-591-01	22 cm (8 ¾")
PRO-04-591-02	22 cm (8 ¾")



**Phaneuf Hysterectomy Forcep**  
Straight, 1 x 2 Teeth

Catalog #	Size
PRO-04-594-21	20.5 cm (8")

**Phaneuf Hysterectomy Forcep**  
Curved, 1 x 2 Teeth

Catalog #	Size
PRO-04-595-21	20 cm (8")



**Maingot Hysterectomy Forcep**  
Curved, 1 x 2 Teeth

Catalog #	Size
PRO-04-597-20	20.5 cm (8")
PRO-04-597-25	25 cm (9 ¾")

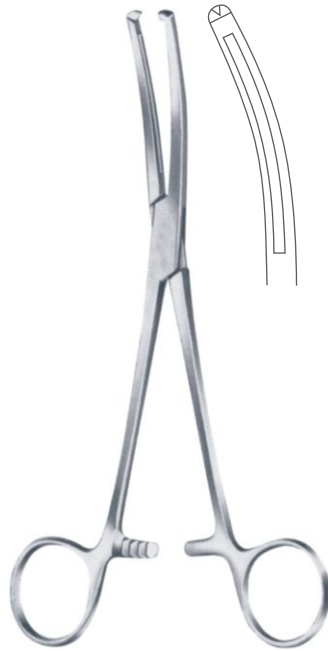

**Maingot Hysterectomy Forcep**  
Straight, 1 x 2 Teeth

Catalog #	Size
PRO-04-598-20	20 cm (8")



**Heaney-Ballentine Hysterectomy Forcep**  
Straight

Catalog #	Size
PRO-04-600-21	21.5 cm (8 ½")

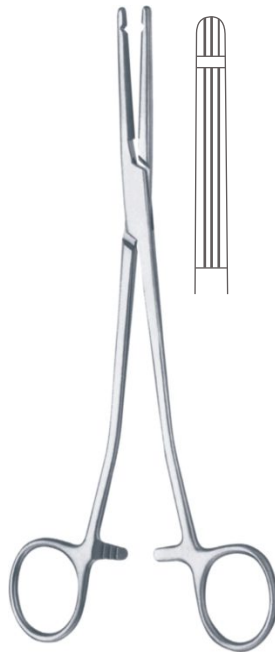

**Heaney-Ballentine Hysterectomy Forcep**  
Curved

Catalog #	Size
PRO-04-601-21	21.5 cm (8 ½")



**Heaney-Razek Hysterectomy Forcep**  
Straight

Catalog #	Size
PRO-04-604-21	21 cm (8 ¼")

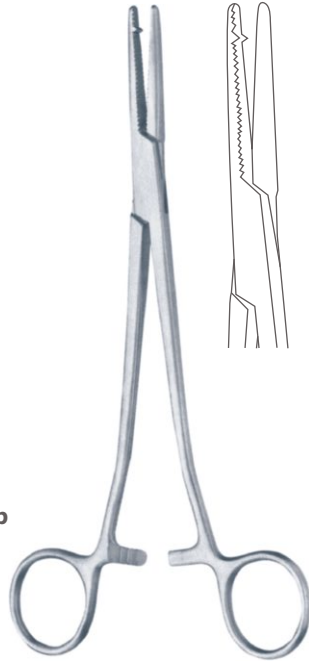

**Heaney Hysterectomy Forcep**  
Curved, 1 Tooth

Catalog #	Size
PRO-04-607-19	19.5 cm (7 ¾")
PRO-04-607-21	21.5 cm (8 ½")
PRO-04-607-23	24 cm (9 ½")



**Heaney Hysterectomy Forcep**  
Curved, 2 Tooth

Catalog #	Size
PRO-04-609-19	19.5 cm (7 ¾")
PRO-04-609-21	21.5 cm (8 ½")
PRO-04-609-23	24 cm (9 ½")



**Dick Atrauma Vaginal Clamp**  
Angled

Catalog #	Size
PRO-04-621-25	25.5 cm (10")
PRO-04-621-26	26.5 cm (10 ½")
PRO-04-621-27	27.5 cm (10 ¾")





**Wertheim Atrauma Vaginal Clamp**  
Right Angled

Catalog #	Size
PRO-04-625-25	25 cm (9 ¾")



**Wertheim-Cullen Vaginal Clamp**

Catalog #	Size
PRO-04-629-21	21 cm (8 ¼")

**Heaney (Rogers) Hysterectomy Forcep**

Catalog #	Size
PRO-04-635-10	21.5 cm (8 1/2"), Fig. 1
PRO-04-635-20	21 cm (8 1/4"), Fig. 2
PRO-04-635-30	20.5 cm (8"), Fig. 3
PRO-04-635-40	20 cm (8"), Fig. 4



Fig. 1

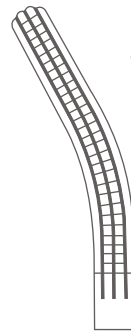

Fig. 2

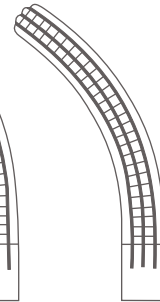

Fig. 3

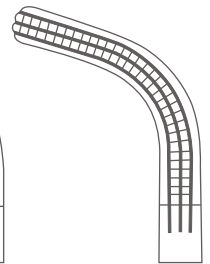

Fig. 4

**Wertheim (Rogers) Hysterectomy Forcep**

Catalog #	Size
PRO-04-637-10	25.5 cm (10"), Fig. 1
PRO-04-637-20	25 cm (9 3/4"), Fig. 2
PRO-04-637-30	24.5 cm (9 3/4"), Fig. 3



Fig. 1

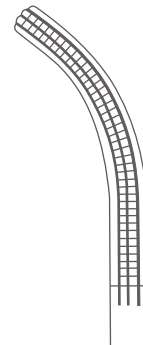

Fig. 2

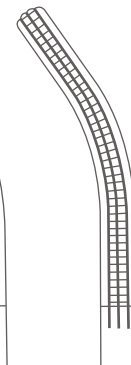

Fig. 3





**Wertheim Hysterectomy Forcep**  
Angled

Catalog #	Size
PRO-04-639-22	22 cm (8 ¾")

**Segond-Landau Hysterectomy Forcep**  
Straight

Catalog #	Size
PRO-04-642-24	24 cm (9 ½")

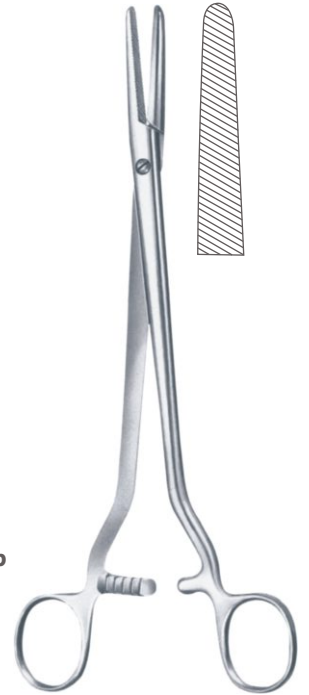

**Segond Hysterectomy Forcep**  
Curved

Catalog #	Size
PRO-04-643-24	24 cm (9 ½")

**Holzbach Hysterectomy Forcep**  
Straight

Catalog #	Size
PRO-04-646-24	24.5 cm (9 ¾")





**Holzbach Hysterectomy Forcep**  
Curved

Catalog #	Size
PRO-04-647-24	24.5 cm (9 3/4")

**Gwilliam Hysterectomy Forcep**  
Straight

Catalog #	Size
PRO-04-648-20	20 cm (8")

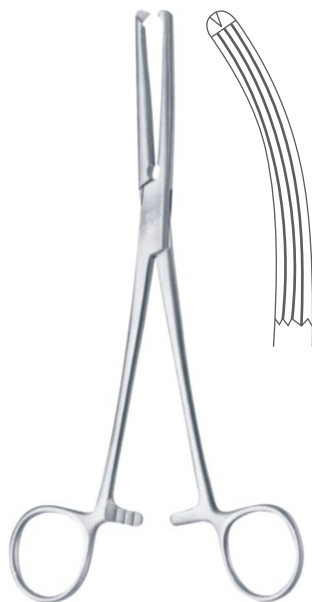
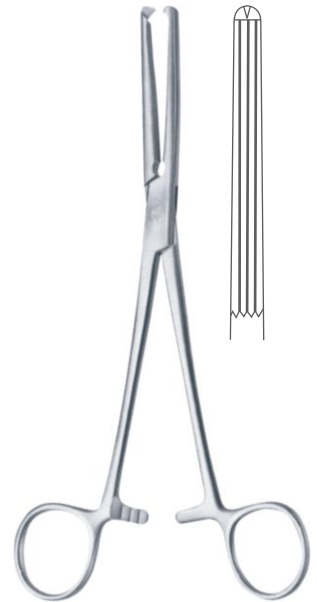

**Gwilliam Hysterectomy Forcep**  
Curved

Catalog #	Size
PRO-04-649-20	20 cm (8")

**Berkeley-Bonney Hysterectomy Forcep**  
Curved

Catalog #	Size
PRO-04-651-20	20 cm (8")

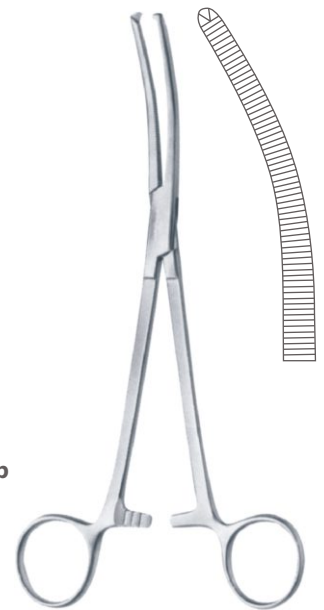

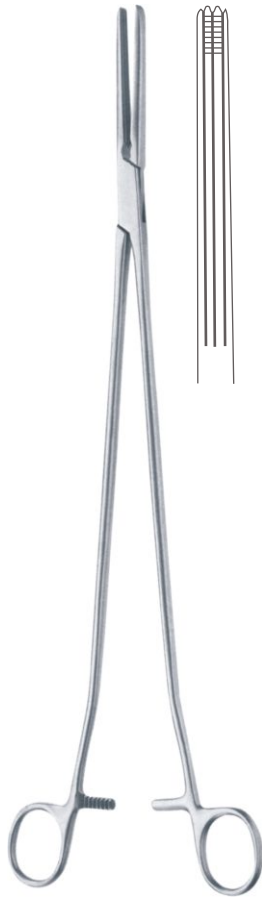

**Kieback Hysterectomy Forcep**  
Straight

Catalog #	Size
PRO-04-654-25	25 cm (9 3/4")

**Kieback Hysterectomy Forcep**  
Curved

Catalog #	Size
PRO-04-655-25	25 cm (9 3/4")



**Burke Hysterectomy Forcep**  
Curved, Short Jaws

Catalog #	Size
PRO-04-657-25	25 cm (9 3/4")

**Burke Hysterectomy Forcep**  
Curved, Long Jaws

Catalog #	Size
PRO-04-659-25	25 cm (9 3/4")





**Moynihan Hysterectomy Forcep**  
Curved

Catalog #	Size
PRO-04-661-23	23 cm (9")

**Moynihan Hysterectomy Forcep**  
Curved

Catalog #	Size
PRO-04-663-24	23.5 cm (9 ¼")

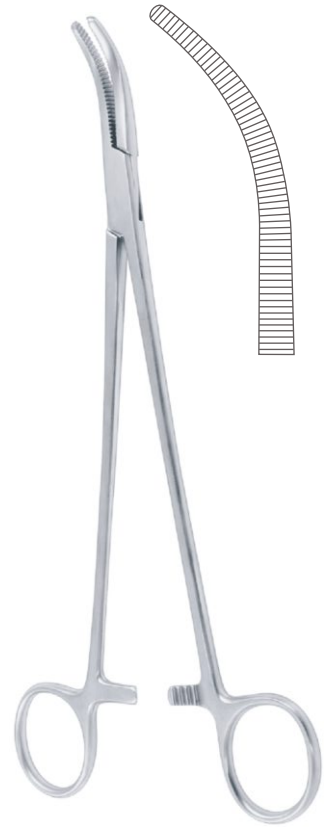

**Wertheim Hysterectomy Forcep**  
Curved

Catalog #	Size
PRO-04-667-25	26 cm (10 ¼")

**Wertheim Hysterectomy Forcep**  
Curved, 1 x 2 Teeth

Catalog #	Size
PRO-04-669-22	22.5 cm (8 ¾")



**Wertheim Hysterectomy Forcep**  
Curved, 1 x 2 Teeth

Catalog #	Size
PRO-04-671-23	22.5 cm (8 ¾")



**Fergusson Angiotribe**  
Straight

Catalog #	Size
PRO-04-680-16	16 cm (6 ¼")
PRO-04-680-20	20 cm (8")



**Fergusson Angiotribe**  
Curved

Catalog #	Size
PRO-04-681-16	16 cm (6 ¼")
PRO-04-681-20	20 cm (8")

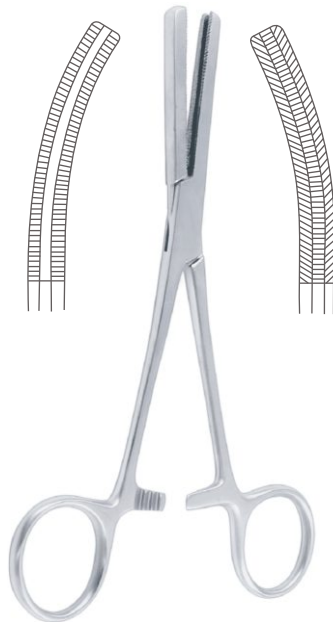

**Mikulicz-Baby Peritoneum Forcep**  
Curved, 1 x 2 Teeth

Catalog #	Size
PRO-04-685-14	14 cm (5 ¾")



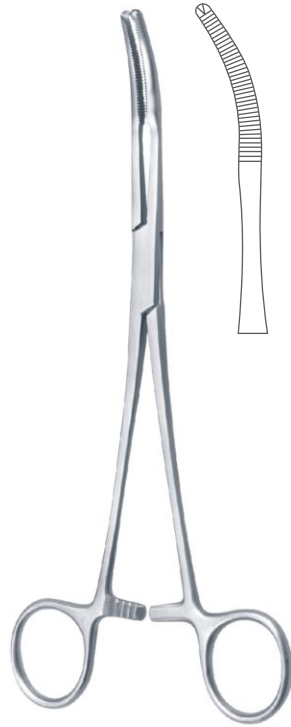

**Mikulicz Peritoneum Forcep**  
Curved, 1 x 2 Teeth

Catalog #	Size
PRO-04-687-18	18.5 cm (7 1/4")

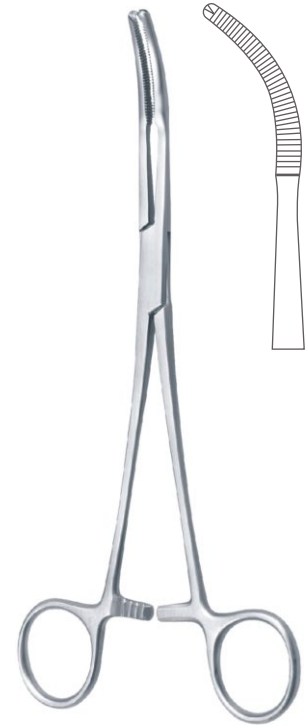

**Mikulicz Peritoneum Forcep**  
Curved, 1 x 2 Teeth

Catalog #	Size
PRO-04-689-20	20 cm (8")

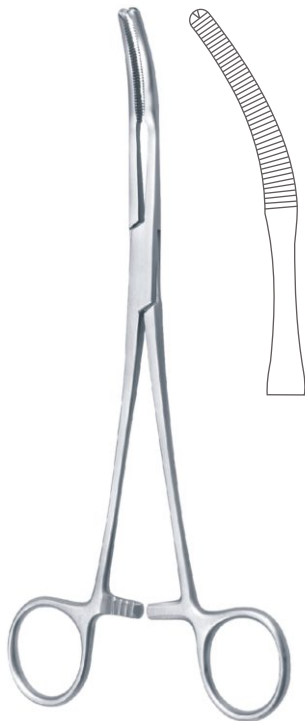

**Mikulicz Peritoneum Forcep**  
Curved, 1 x 2 Teeth

Catalog #	Size
PRO-04-691-20	20 cm (8")



**Mikulicz Peritoneum Forcep**  
Curved, Longitudinal Serrations, 1 x 2 Teeth

Catalog #	Size
PRO-04-693-24	24.5 cm (9 3/4")



**Mikulicz Peritoneum Forcep**  
Curved, 1 x 2 Teeth

Catalog #	Size
PRO-04-695-21	20.5 cm (8")

**Faure Peritoneum Forcep**  
Curved, 1 x 2 Teeth

Catalog #	Size
PRO-04-697-20	21 cm (8 ¼")

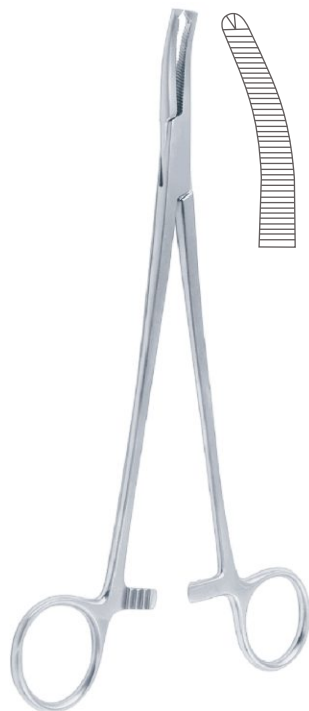
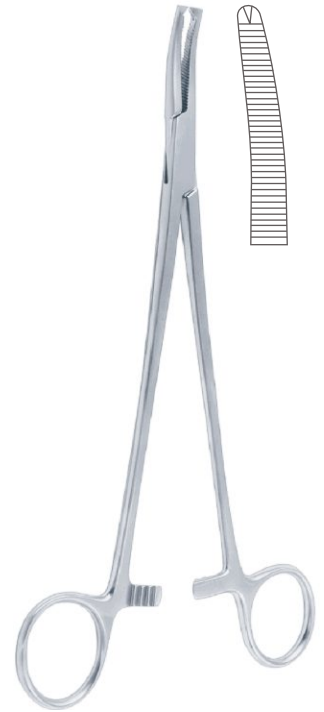

**Faure Peritoneum Forcep**  
Curved, 1 x 2 Teeth

Catalog #	Size
PRO-04-699-20	21 cm (8 ¼")

**Doyen Towel Clamp**

Catalog #	Size
PRO-04-751-18	18 cm (7")

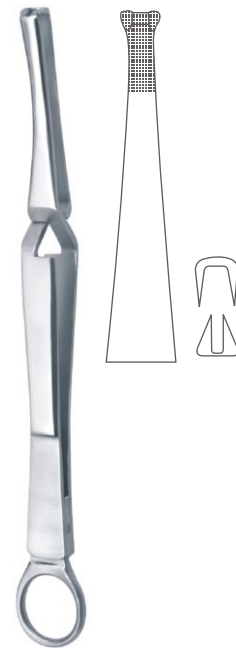



**Schaedel Towel Clamp**  
Sharp

Catalog #	Size
PRO-04-755-09	9 cm (3 1/2")

**Jones Towel Clamp**  
Sharp

Catalog #	Size
PRO-04-761-05	5.5 cm (2 1/2")
PRO-04-761-09	8.5 cm (3 1/4")



**Martin-Jones Towel Clamp**  
Sharp, With Cable Holder

Catalog #	Size
PRO-04-765-09	8.5 cm (3 1/4")

**Robin Towel Clamp**  
With Cable Holder

Catalog #	Size, Usage
PRO-04-769-01	13.5 cm (5 1/4"), For Cable Up To 5 mm
PRO-04-769-02	13.5 cm (5 1/4"), For Cable Up To 13 mm





**Backhaus Towel Clamp**  
With Tube Holder

Catalog #	Size
PRO-04-771-11	13 cm (5")



**Backhaus Towel Clamp**

Catalog #	Size
PRO-04-773-08	9 cm (3 ½")
PRO-04-773-11	11.5 cm (4 ½")
PRO-04-773-13	13 cm (5")
PRO-04-773-15	16 cm (6 ¼")



**Roeder Towel Clamp**

Catalog #	Size
PRO-04-777-13	13.5 cm (5 ¼")



**Lorna Towel Clamp**  
Fine Serrated, Wide Jaw

Catalog #	Size
PRO-04-781-10	9.5 cm (3 ¾")
PRO-04-781-13	13 cm (5")



**Bernhard Towel Clamp**

Catalog #	Size
PRO-04-785-16	16.5 cm (6 ½")



**Tohoku Towel Clamp**  
Blunt

Catalog #	Size
PRO-04-787-10	10.5 cm (4")
PRO-04-787-13	13.5 cm (5 ¼")



**Non Perforating Towel Clamp**

Catalog #	Size
PRO-04-791-10	10 cm (4")
PRO-04-791-13	13.5 cm (5 ¼")

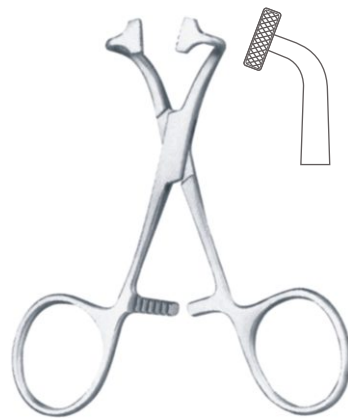

**Peers-Bretram Towel Clamp**  
With Jaw for Tube Fixation

Catalog #	Size
PRO-04-793-14	14.5 cm (5 ¾")

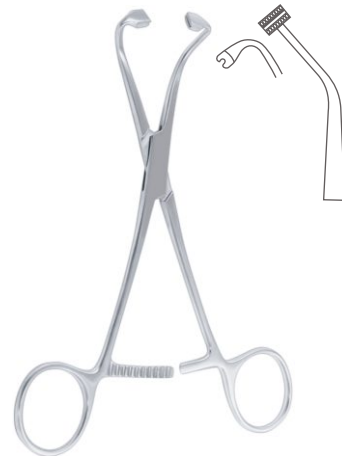

**Towel Clamp**  
For Paper Clothes

Catalog #	Size
PRO-04-795-11	11.5 cm (4 ½")
PRO-04-795-14	14 cm (5 ½")

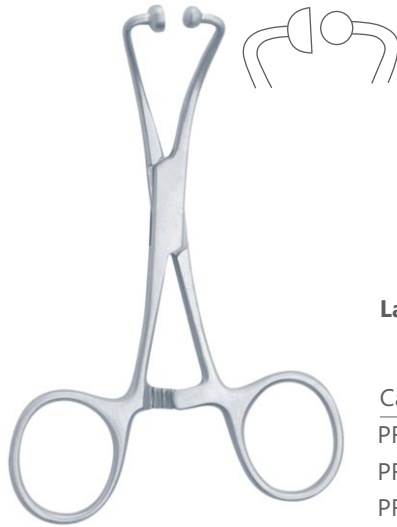

**Lane Towel Clamp**

Catalog #	Size
PRO-04-799-13	13 cm (5")
PRO-04-799-15	15.5 cm (6")
PRO-04-799-20	19.5 cm (7 ¾")



**Klinikum Berlin Tubing Clamp**  
Extra Long Ratchet

Catalog #	Size
PRO-04-850-14	14 cm (5 ½")



**Presbyterian Tubing Clamp**

Catalog #	Size
PRO-04-852-16	16.5 cm (6 ½")
PRO-04-852-18	18 cm (7")



**Tubing Clamp**

Catalog #	Size
PRO-04-860-15	15.5 cm (6")
PRO-04-860-18	19 cm (7 ½")
PRO-04-860-20	20.5 cm (8")



**Tubing Clamp  
With Safety Guard**

Catalog #	Size
PRO-04-862-15	15.5 cm (6")
PRO-04-862-18	19 cm (7 ½")
PRO-04-862-20	20.5 cm (8")



**Brompton Tube Milking Roller**

Catalog #	Size
PRO-04-890-00	Standard



**Hoffmann Tubing Clamp**

Catalog #	Width
PRO-04-950-13	13 mm
PRO-04-950-17	17 mm
PRO-04-950-20	20 mm
PRO-04-950-25	25 mm
PRO-04-950-30	30 mm
PRO-04-950-40	40 mm



**Mohr Pinchcocks**

Catalog #	Width
PRO-04-953-40	40 mm
PRO-04-953-50	50 mm
PRO-04-953-60	60 mm
PRO-04-953-70	70 mm
PRO-04-953-80	80 mm

