



PRECISION[™]
SURGICAL WORKS

STOMACH, INTESTINES, RECTUM

Magen, Darm, Rektum

Estómago, Intestinos, Recto

Estomac, Intestins, Rectum

Stomaco, Intestini, Retto

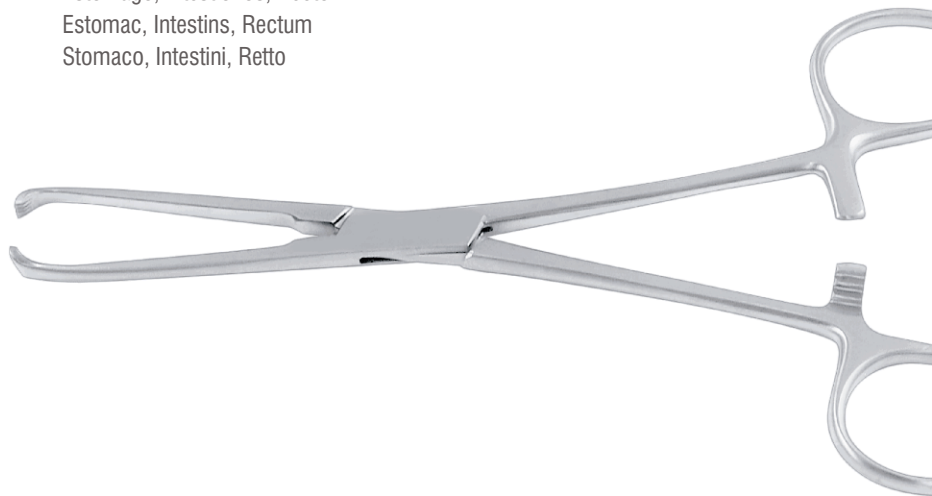



Allis-Baby Intestinal and Tissue Grasping Forcep
4 x 5 Teeth

Catalog #	Size
PRO-15-010-12	13 cm (5")



Allis Intestinal and Tissue Grasping Forcep
4 x 5 Teeth

Catalog #	Size
PRO-15-012-15	15.5 cm (6")



Allis Intestinal and Tissue Grasping Forcep
5 x 6 Teeth

Catalog #	Size
PRO-15-015-15	15.5 cm (6")
PRO-15-015-19	19 cm (7 1/2")
PRO-15-015-25	25.5 cm (10")



Allis Atrauma Intestinal and Tissue Grasping Forcep

Catalog #	Size
PRO-15-020-16	15.5 cm (6")
PRO-15-020-20	20 cm (8")
PRO-15-020-25	24.5 cm (9 ¾")
PRO-15-020-30	30 cm (11 ¾")



Allis-Adair Intestinal and Tissue Grasping Forcep
10 x 11 Teeth

Catalog #	Size
PRO-15-024-15	16 cm (6 ¼")



Boys-Allis Intestinal and Tissue Grasping Forcep

5 x 6 Teeth

Catalog #	Size
PRO-15-026-15	15.5 cm (6")



Judd-Allis Intestinal and Tissue Grasping Forcep

3 x 4 Teeth

Catalog #	Size
PRO-15-028-15	15.5 cm (6")
PRO-15-028-19	19 cm (7 ½")



Thomas-Allis Intestinal and Tissue Grasping Forcep
6 x 7 Teeth

Catalog #	Size
PRO-15-030-20	20.5 cm (8")



Allis Intestinal and Tissue Grasping Forcep
5 x 6 Teeth

Catalog #	Size
PRO-15-032-20	20 cm (8")

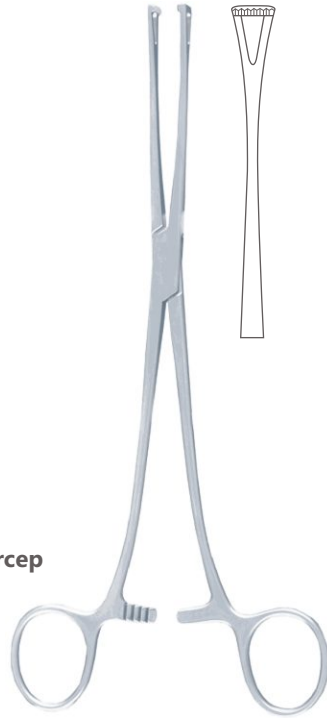

Lockwood Intestinal and Tissue Grasping Forcep

Catalog #	Size
PRO-15-040-20	20 cm (8")



Littlewood Intestinal and Tissue Grasping Forcep

Catalog #	Size
PRO-15-042-18	18.5 cm (7 1/4")



Williams Intestinal and Tissue Grasping Forcep

Catalog #	Size
PRO-15-050-16	16.5 cm (6 ½")



UltaGrip™ TC Babcock Intestinal and Tissue Grasping Forcep

Catalog #	Size
PRO-15-056-16	16.5 cm (6 ½")
PRO-15-056-20	21 cm (8 ¼")



Babcock Intestinal and Tissue Grasping Forcep

Catalog #	Size
PRO-15-060-16	15.5 cm (6")
PRO-15-060-18	17.5 cm (7")
PRO-15-060-20	21 cm (8 ¼")
PRO-15-060-24	24 cm (9 ½")



Babcock Atrauma Intestinal and Tissue Grasping Forcep

Catalog #	Size
PRO-15-062-16	16 cm (6 ¼")
PRO-15-062-20	20.5 cm (8")



UltraGrip™ TC Duval Intestinal and Tissue Grasping Forcep

Catalog #	Size
PRO-15-070-20	20.5 cm (8")



Duval Intestinal and Tissue Grasping Forcep
Narrow Jaw

Catalog #	Size
PRO-15-072-18	18 cm (7")

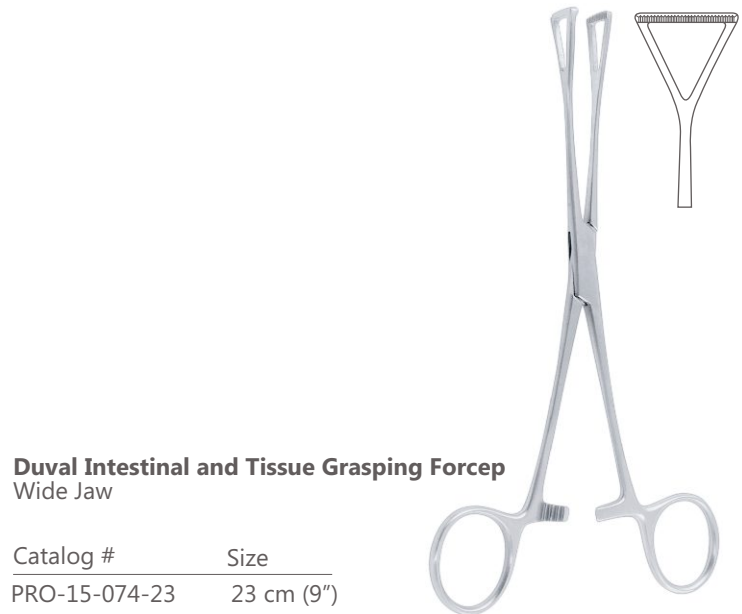

Duval Intestinal and Tissue Grasping Forcep
Wide Jaw

Catalog #	Size
PRO-15-074-23	23 cm (9")

Doyen-Baby Intestinal Clamp
Straight

Catalog #	Size
PRO-15-100-18	18 cm (7")



Doyen-Baby Intestinal Clamp
Curved

Catalog #	Size
PRO-15-101-18	17.5 cm (7")



Doyen Intestinal Clamp
Straight

Catalog #	Size
PRO-15-102-23	23.5 cm (9 ¼")



Doyen Intestinal Clamp
Curved

Catalog #	Size
PRO-15-103-23	23 cm (9")





Mayo-Robson Intestinal Clamp
Straight

Catalog #	Size
PRO-15-110-21	21.5 cm (8 ½")
PRO-15-110-23	23.5 cm (9 ¼")
PRO-15-110-25	25.5 cm (10")

Mayo-Robson Intestinal Clamp
Curved

Catalog #	Size
PRO-15-111-21	21.5 cm (8 ½")
PRO-15-111-23	23 cm (9")
PRO-15-111-25	24.5 cm (9 ¾")



Kocher-Baby Intestinal Clamp
Straight

Catalog #	Size
PRO-15-120-13	13 cm (5")

Kocher-Baby Intestinal Clamp
Curved

Catalog #	Size
PRO-15-121-13	13 cm (5")





Kocher Intestinal Clamp
Straight

Catalog #	Size
PRO-15-122-22	22.5 cm (8 ¾")
PRO-15-122-25	25 cm (9 ¾")
PRO-15-122-28	28.5 cm (11 ¼")

Kocher Intestinal Clamp
Curved

Catalog #	Size
PRO-15-123-22	22.5 cm (8 ¾")
PRO-15-123-25	24.5 cm (9 ¾")
PRO-15-123-28	27.5 cm (10 ¾")



Allen Intestinal Clamp

Catalog #	Size
PRO-15-128-16	16 cm (6 ¼")

Payr-Baby Intestinal Clamp

Catalog #	Size
PRO-15-131-15	15 cm (6")

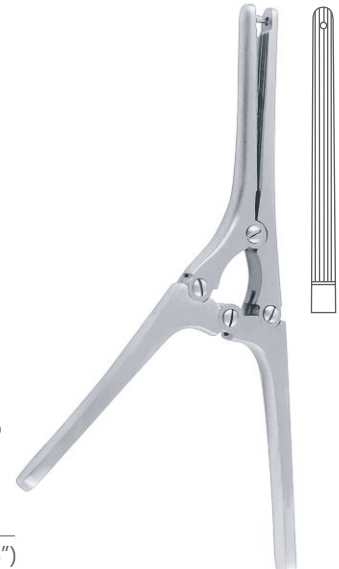

Payr Intestinal Clamp

Catalog #	Size
PRO-15-133-21	20.5 cm (8")
PRO-15-133-29	29 cm (11 1/2")
PRO-15-133-35	34.5 cm (13 1/2")



**Nussbaum Intestinal Clamp
Straight**

Catalog #	Size
PRO-15-138-25	25 cm (9 3/4")

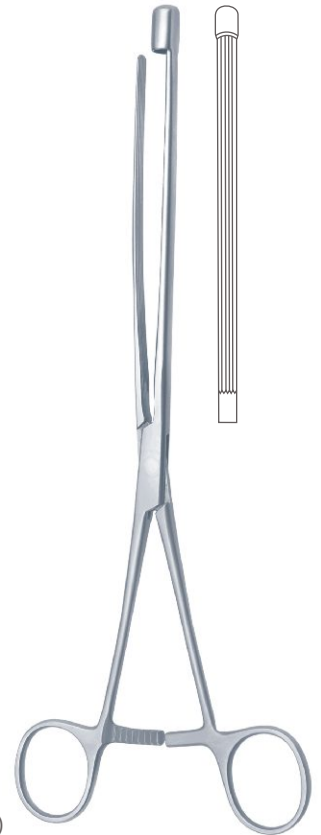

**Nussbaum Intestinal Clamp
Curved**

Catalog #	Size
PRO-15-139-25	25 cm (9 3/4")

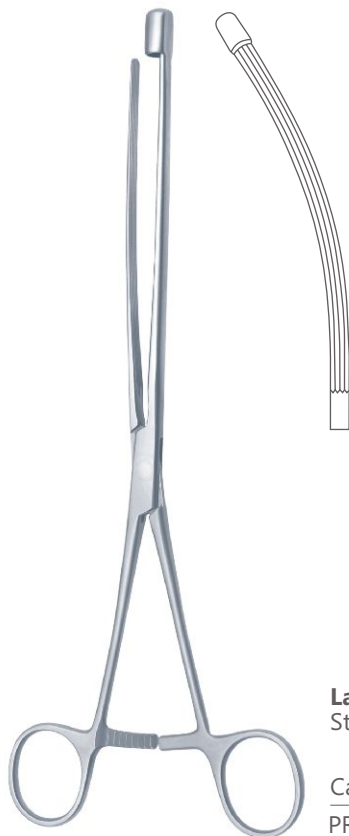

**Lane Intestinal Clamp
Straight**

Catalog #	Size
PRO-15-150-30	30 cm (11 3/4")





Lane Intestinal Clamp
Curved

Catalog #	Size
PRO-15-151-30	30 cm (11 3/4")

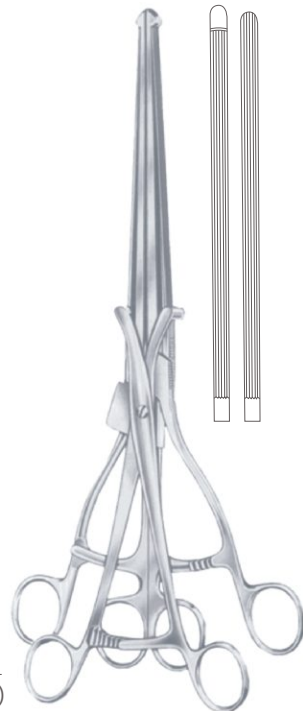

Haberer Intestinal Clamp

Catalog #	Size
PRO-15-156-36	36 cm (14 1/4")

Scudder Intestinal Clamp
Straight

Catalog #	Size
PRO-15-160-33	33.5 cm (13 1/4")

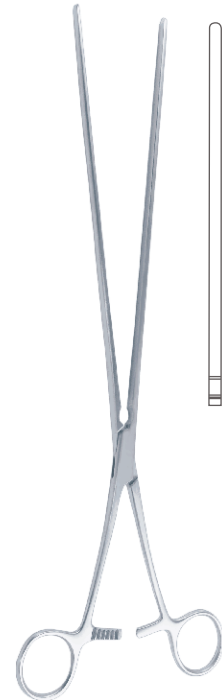



Scudder Intestinal Clamp
Curved

Catalog #	Size
PRO-15-161-33	32.5 cm (12 3/4")



Brunner Sigmoid Anastomosis Clamp

Catalog #	Size
PRO-15-165-24	24 cm - (9 1/2")

De Martel-Wolfson Intestinal Anastomosis Clamp

Catalog #	Jaw Length
PRO-15-172-01	65 mm
PRO-15-172-02	80 mm
PRO-15-172-03	110 mm

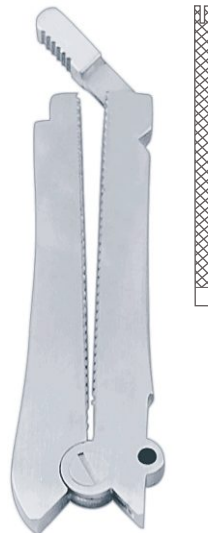



De Martel-Wolfson Closing Forcep

Catalog #	Size
PRO-15-179-25	25 cm (9 3/4")

De Martel-Wolfson Clamp Holder

Catalog #	Size
PRO-15-180-09	9.5 cm (3 3/4")
PRO-15-180-23	23 cm (9")



Benson Pylorus Spreader

Catalog #	Size
PRO-15-186-15	15.5 cm (6")

Scheibe (Collin) Atrauma Organ Grasping

Catalog #	Size, Profile
PRO-15-190-18	18 cm (7"), Narrow Jaw
PRO-15-190-20	20.5 cm (8"), Medium Jaw
PRO-15-190-23	23 cm (8"), Wide Jaw

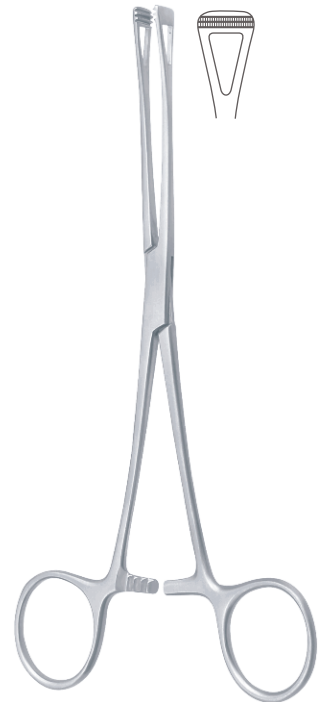



Doyen-Baby Atrauma Intestinal Clamp
Straight

Catalog #	Size
PRO-15-200-13	14 cm (5")

Doyen-Baby Atrauma Intestinal Clamp
Curved

Catalog #	Size
PRO-15-201-13	13.5 cm (5 ¼")

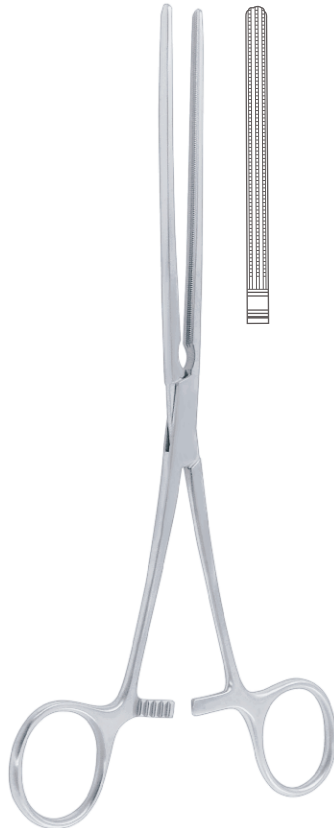
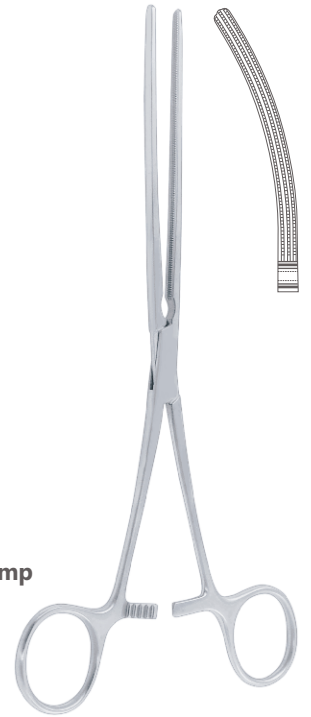

Doyen Atrauma Intestinal Clamp
Straight

Catalog #	Size
PRO-15-202-16	17 cm (6 ¾")
PRO-15-202-18	18.5 cm (7 ¼")
PRO-15-202-21	21.5 cm (8 ½")
PRO-15-202-23	23.5 cm (9 ¼")

Doyen Atrauma Intestinal Clamp
Curved

Catalog #	Size
PRO-15-203-16	17 cm (6 ¾")
PRO-15-203-18	18 cm (7")
PRO-15-203-21	21 cm (8 ¼")
PRO-15-203-23	23 cm (9")

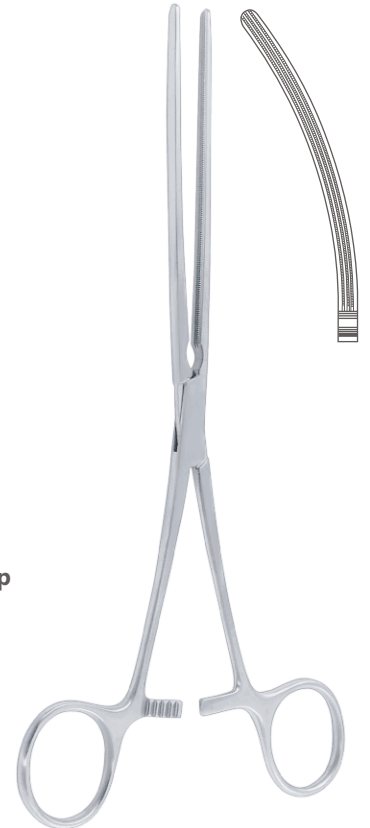



Mayo-Robson Atrauma Intestinal Clamp
Straight

Catalog #	Size
PRO-15-210-25	26 cm (10 1/4")



Mayo-Robson Atrauma Intestinal Clamp
Curved

Catalog #	Size
PRO-15-211-25	25 cm (9 3/4")



Kocher Atrauma Intestinal Clamp
Straight

Catalog #	Size
PRO-15-220-22	22.5 cm (8 3/4")
PRO-15-220-25	25.5 cm (10")
PRO-15-220-28	28 cm (11")



Kocher Atrauma Intestinal Clamp
Curved

Catalog #	Size
PRO-15-221-22	22 cm (8 3/4")
PRO-15-221-25	25 cm (9 3/4")
PRO-15-221-28	27.5 cm (10 3/4")



Scudder Atrauma Intestinal Clamp
Straight

Catalog #	Size
PRO-15-230-33	33.5 cm (13 ¼")

Scudder Atrauma Intestinal Clamp
Curved

Catalog #	Size
PRO-15-231-33	32.5 cm (12 ¾")



Brunner Atrauma Sigmoid Anastomosis Clamp

Catalog #	Size
PRO-15-241-27	27 cm (10 ¾")

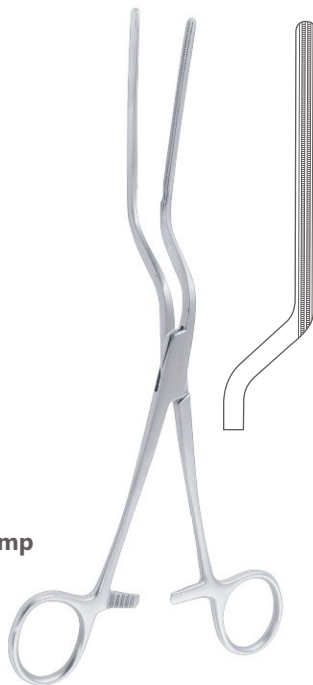

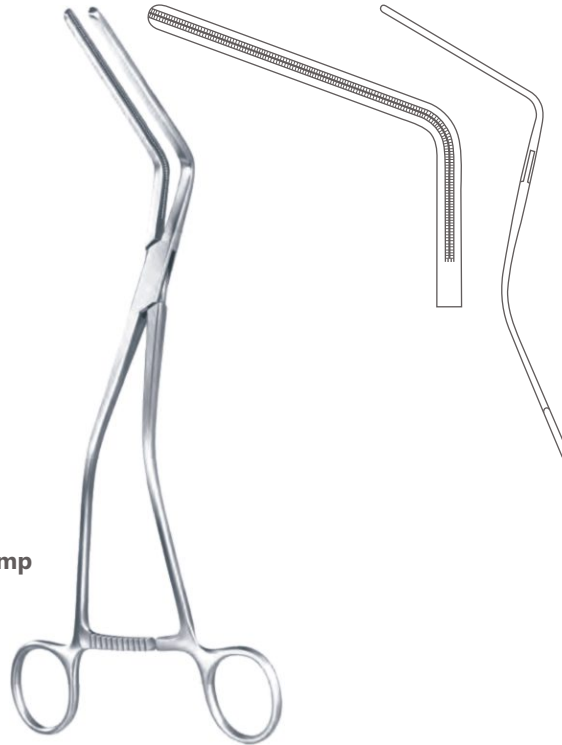

Hayes Atrauma Sigmoid Anastomosis Clamp

Catalog #	Size
PRO-15-251-26	27 cm (10 ¾")
PRO-15-251-28	28 cm (11")



Veidenheimer Atrauma Sigmoid Anastomosis Clamp

Catalog #	Size
PRO-15-255-23	25 cm (9 ¾")



Fehland Atrauma Sigmoid Anastomosis Clamp

Catalog #	Size
PRO-15-259-24	24 cm (9 ½")

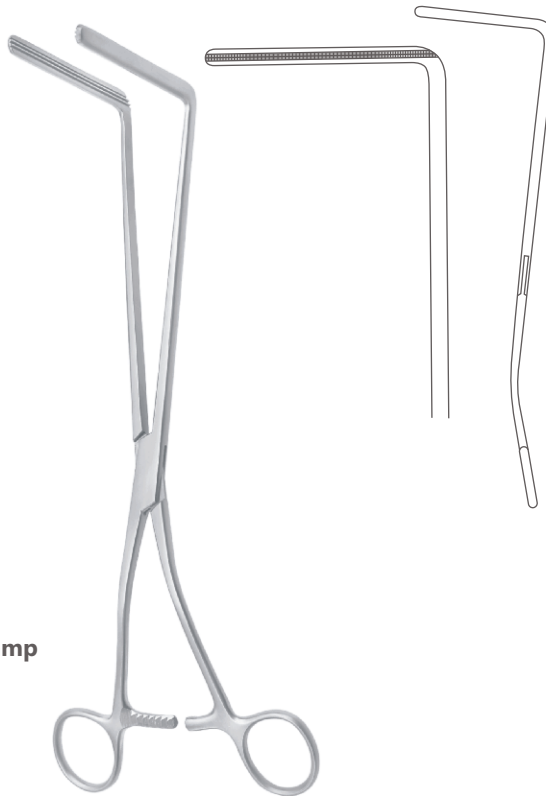

Resano Atrauma Sigmoid Anastomosis Clamp

Catalog #	Size
PRO-15-261-30	28 cm (11")



Czerny Rectal Speculum

Catalog #	Size
PRO-15-301-22	22 cm (8 ¾")



Pratt Rectal Speculum

Catalog #	Size, Blade Size
PRO-15-311-20	20.5 cm (8"), 80 x 25 mm



Sims Rectal Speculum

Catalog #	Size, Blade Size
PRO-15-321-15	15.5 cm (6"), 70 x 15 mm



**Sims Rectal Speculum
With Fiber Optic Illumination**

Catalog #	Size
PRO-15-323-15	15.5 cm (6")



Sims Rectal Speculum
Fenestrated Blades

Catalog #	Size, Blade Size
PRO-15-327-15	15.5 cm (6"), 70 x 15 mm



Sims (Schulze-Bergmann) Rectal Speculum

Catalog #	Size, Blade Size
PRO-15-331-01	22 cm (8 3/4"), 60 mm
PRO-15-331-02	22 cm (8 3/4"), 80 mm
PRO-15-331-03	22 cm (8 3/4"), 125 mm
PRO-15-331-04	22 cm (8 3/4"), 150 mm

Sims (Schulze-Bergmann) Rectal Speculum
With Fiber Optic Illumination

Catalog #	Size
PRO-15-335-22	22 cm (8 3/4")



Fiber Optic No Shown



Mathieu Rectal Speculum

Catalog #	Size, Blade Length
PRO-15-341-19	19.5 cm (7 ¾"), 90 mm

Barr Rectal Speculum

Catalog #	Size, Blade Size
PRO-15-343-17	17 cm (6 ¾"), 70 x 22 mm



Parks Rectal Speculum

Catalog #	Size
PRO-15-351-00	Standard

**Parks Rectal Speculum
With Fiber Optic Illumination**

Catalog #	Size
PRO-15-355-00	Standard





Alan-Parks Rectal Speculum

Catalog #	Size
PRO-15-361-00	Standard



**Alan-Parks Rectal Speculum
With Fiber Optic Illumination**

Catalog #	Size
PRO-15-365-00	Standard



Roschke Anal Retractor

Catalog #	Blade Size
PRO-15-371-00	70 x 30 mm



**Roschke Anal Retractor
With Fiber Optic Illumination**

Catalog #	Blade Size
PRO-15-375-00	70 x 30 mm



Hirschmann Anoscope

Catalog #	Diameter, Working Length, Profile
PRO-15-381-01	Ø 16 mm, 60 mm, Fig. 1
PRO-15-381-02	Ø 19 mm, 70 mm, Fig. 2
PRO-15-381-03	Ø 24 mm, 90 mm, Fig. 3
PRO-15-381-04	Ø 24 mm, 130 mm, Fig. 4



Hirschman Anoscope
With Fiber Optic Illumination

Catalog #	Diameter, Working Length, Profile
PRO-15-385-01	Ø 16 mm, 60 mm, Fig. 1
PRO-15-385-02	Ø 19 mm, 70 mm, Fig. 2
PRO-15-385-03	Ø 24 mm, 90 mm, Fig. 3
PRO-15-385-04	Ø 24 mm, 130 mm, Fig. 4

Ives-Fansler Anoscope

Catalog #	Diameter, Working Length
PRO-15-391-00	Ø 22 mm, 95 mm





Ives-Fansler Anoscope
With Fiber Optic Illumination

Catalog #	Diameter, Working Length
PRO-15-395-00	Ø 22 mm, 95 mm

Anoscope
With Obturator

Catalog #	Diameter, Working Length
PRO-15-401-00	Ø 21 mm, 80 mm



Anoscope
With Obturator

Catalog #	Diameter, Working Length
PRO-15-403-01	Ø 26 mm, 60 mm
PRO-15-403-02	Ø 24 mm, 80 mm





Kelly Proctoscope

Catalog #	Diameter, Working Length, Profile
PRO-15-411-01	Ø 22 mm, 50 mm, Fig. 1
PRO-15-411-02	Ø 22 mm, 100 mm, Fig. 2
PRO-15-411-03	Ø 22 mm, 140 mm, Fig. 3
PRO-15-411-04	Ø 22 mm, 200 mm, Fig. 4



**Proctoscope
With Obturator**

Catalog #	Diameter, Working Length
PRO-15-415-00	Ø 22 mm, 120 mm

**Blond Proctoscope Complete
With Conventional Illumination and Tube**

Catalog #	Size
PRO-15-431?-00	Standard





Battery Handle Only
For 2 x "C" Type Batteries

Catalog #	Size
PRO-15-431-01	Standard

Head End Only



Catalog #	Size
PRO-15-431-02	Standard

Bulb
Head End Only

Catalog #	Power Rating
PRO-15-431-09	2.5



Bulb
Short for Head End Only

Catalog #	Power Rating
PRO-15-431-10	2.5



Blond Proctoscope Complete
With Fiber Optic Illumination and Tube

Catalog #	Size
PRO-15-435-00	Standard



Illumination Handle only
With Head End

Catalog #	Size
PRO-15-435-01	Standard



Adaptor
Storz Type

Catalog #	Size
PRO-15-435-05	Standard



Blond Proctoscope Tube

Catalog #	Diameter, Working Length
PRO-15-440-01	Ø 18:24 mm, 75 mm
PRO-15-440-02	Ø 15:23 mm, 75 mm
PRO-15-440-03	Ø 18:25 mm, 105 mm



Blond Proctoscope Tube
Circular Fenestration

Catalog #	Diameter, Working Length
PRO-15-442-01	Ø 18:24 mm, 75 mm



Morgan Proctoscope
With Fiber Optic Illumination

Catalog #	Diameter, Working Length
PRO-15-451-01	Ø 17 mm, 65 mm
PRO-15-451-02	Ø 17 mm, 80 mm
PRO-15-451-03	Ø 20 mm, 65 mm
PRO-15-451-04	Ø 20 mm, 80 mm
PRO-15-451-05	Ø 24 mm, 65 mm
PRO-15-451-06	Ø 24 mm, 80 mm

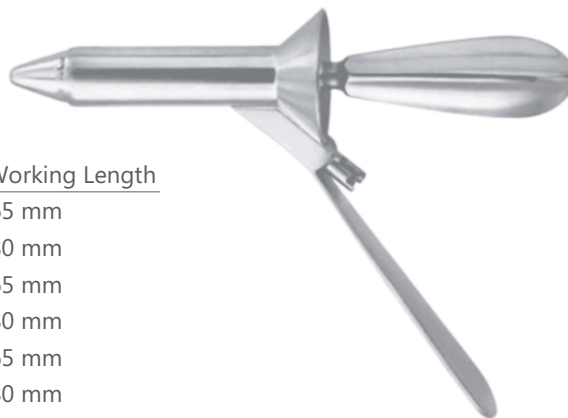



Morgan Fibre Optic Illuminator
Connectors Type Storz, Wolf, ACM

Catalog #	Size
PRO-15-455-00	Standard

Kelly Sphincteroscope

Catalog #	Diameter, Diameter, Profile
PRO-15-471-01	Ø 21 mm, 50 mm, Fig. 1
PRO-15-471-02	Ø 27 mm, 50 mm, Fig. 2



Rectoscope Complete

Catalog #	Size
PRO-15-500-00	Standard

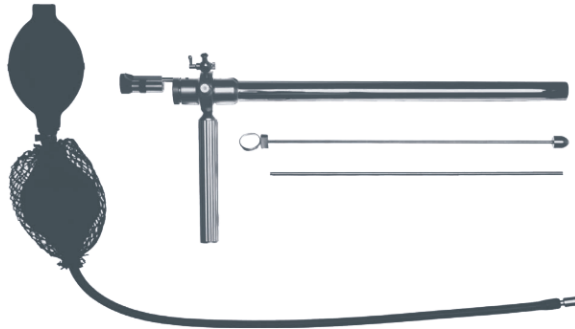

Strauss Rectoscope Complete

Catalog #	Size
PRO-15-510-00	Standard

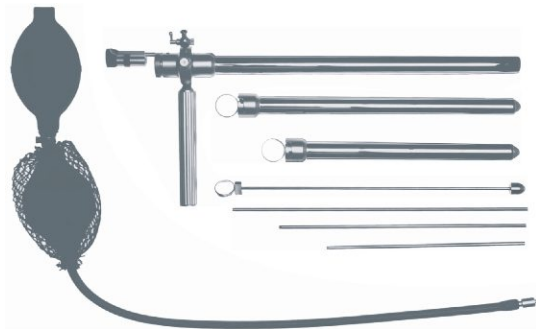

Recto-Proctoscope Complete

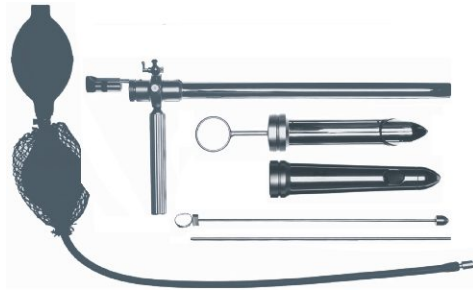

Catalog #	Size
PRO-15-520-00	Standard

Battery Handle Only
For 2 x "AAA" Type Batteries



Catalog #	Size
PRO-15-530-01	Standard

Spare Bulb
Xenon



Catalog #	Power Rating
PRO-15-530-09	2.5 V

Adapter
Wolf Type



Catalog #	Size
PRO-15-532-01	Standard

Adapter
Storz / Olympus Type



Catalog #	Size
PRO-15-532-02	Standard

Adapter
Storz / Olympus Type / Aesculap Type



Catalog #	Size
PRO-15-532-03	Standard

Rectoscope Head
With 2 Way Stopcock, Connector Type Wolf



Catalog #	Size
PRO-15-534-01	Standard

Handle for Rectoscope Head



Catalog #	Size
PRO-15-534-02	Standard

Rectoscope Obturator

Catalog #	Size
PRO-15-536-01	Standard
PRO-15-536-02	Standard
PRO-15-536-03	Standard



Rectoscope Tube

Catalog #	Size
PRO-15-538-01	Standard
PRO-15-538-02	Standard
PRO-15-538-03	Standard



Fiber Optic Light Guide

Catalog #	Size
PRO-15-540-01	Standard
PRO-15-540-02	Standard
PRO-15-540-03	Standard



Conical Tube

Catalog #	Size
PRO-15-542-01	Standard



Anuscope With Obturator

Catalog #	Size
PRO-15-544-01	Standard



Telescope

Catalog #	Size
PRO-15-546-00	Standard



Swivel Lens



Cover



Catalog #	Size
PRO-15-548-00	Standard

Catalog #	Size
PRO-15-550-00	Standard

Double-Blower
With Luer Lock



Catalog #	Size
PRO-15-560-00	Standard

Norwood Rectal Snare



Catalog #	Size
PRO-15-601-30	30 cm (11 3/4")

Blue Rectal Aspiration Cannula
10 Charr.



Catalog #	Size, Diameter
PRO-15-607-40	40 cm (15 3/4"), Ø 3.3 mm



McGivney Suction Hemorrhoidal Ligator Complete
With 10 mm Suction Head and Charging Cone

Catalog #	Size
PRO-15-651-00	Standard



Suction Hemorrhoidal Ligature Complete
Angled 30° Up, With 10 mm Suction Head and Charging Cone

Catalog #	Size
PRO-15-655-00	Standard



Suction Hemorrhoidal Ligator Complete

Angled 30° Down, With 10 mm Suction Head and Charging Cone

Catalog #	Size
PRO-15-657-00	Standard



Rudd Hemorrhoidal Ligator Complete

With 12 mm Charging Cone

Catalog #	Size
PRO-15-670-00	31.5 cm (12 ½")

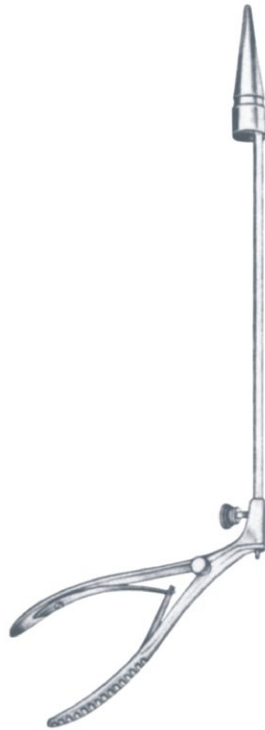

McGivney Hemorrhoidal Ligator Complete
With 12 mm Charging Cone

Catalog #	Size
PRO-15-675-00	Standard



Ford Dixon Hemorrhoidal Ligator Complete
With 12 mm Charging Cone

Catalog #	Size
PRO-15-677-00	Standard

Rubber Ligator Rings
Pack of 100

Catalog #	Size
PRO-15-680-00	Standard



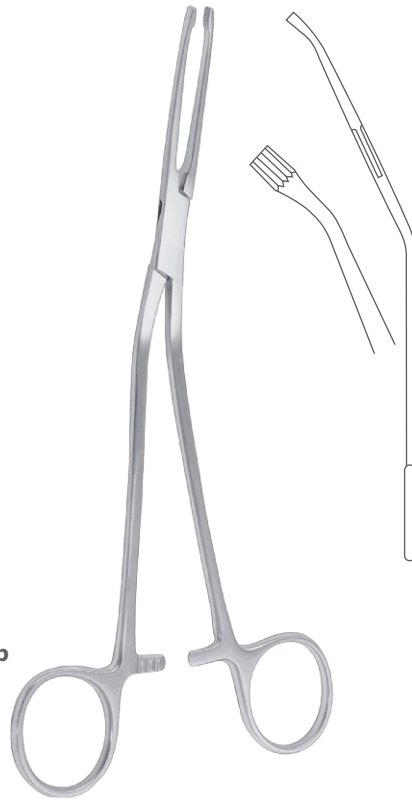

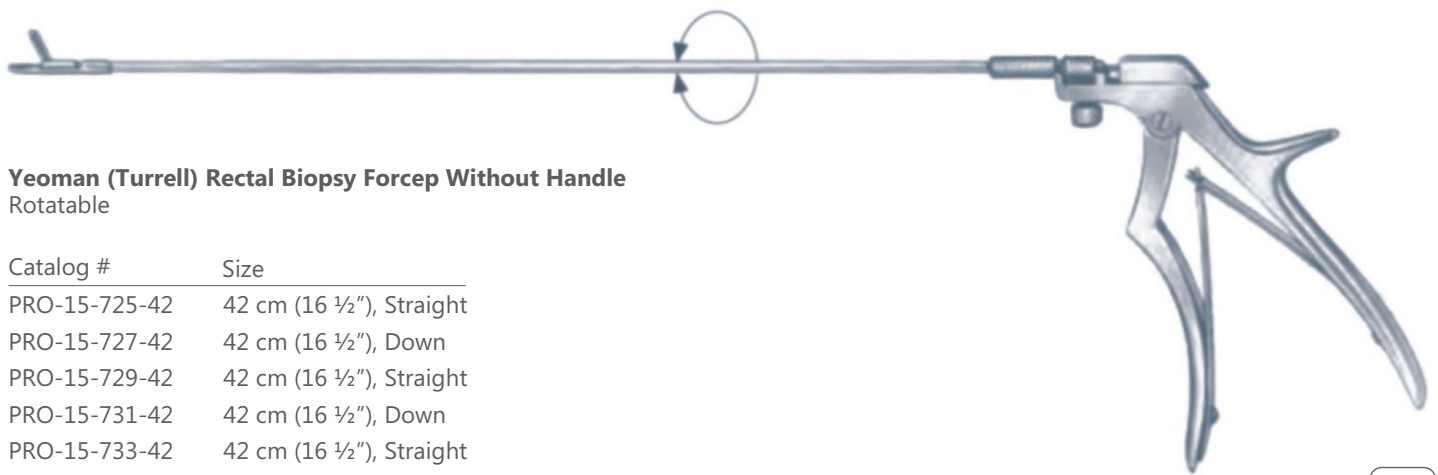

McGivney Hemorrhoidal Grasping Forcep

Catalog #	Size
PRO-15-691?-19	19 cm (7 1/2")



Yeoman (Turrell) Rectal Biopsy Forcep Without Handle
Rotatable

Catalog #	Size
PRO-15-725-42	42 cm (16 1/2"), Straight
PRO-15-727-42	42 cm (16 1/2"), Down
PRO-15-729-42	42 cm (16 1/2"), Straight
PRO-15-731-42	42 cm (16 1/2"), Down
PRO-15-733-42	42 cm (16 1/2"), Straight

-  Straight
-  Down
-  Straight
-  Down
-  Straight



Handle Only

Catalog #	Size
PRO-15-735-00	Standard

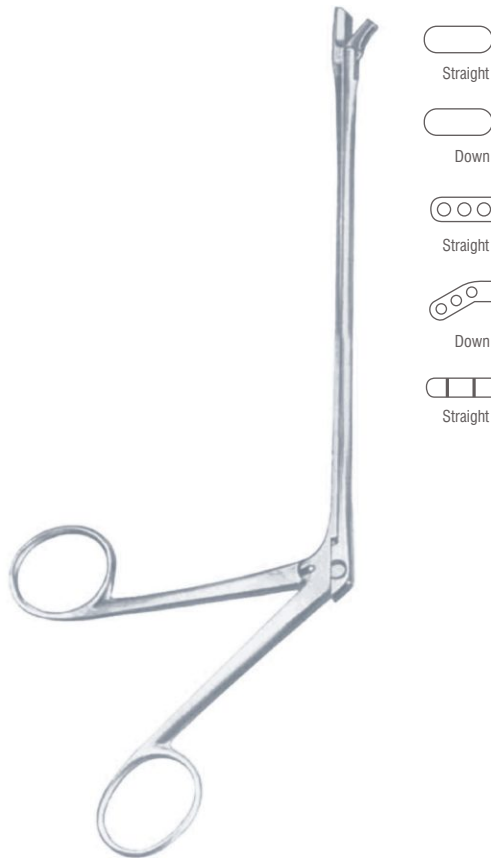

Yeoman (Turrell) Rectal Biopsy Forcep Complete

Catalog #	Size, Profile
PRO-15-735-01	42 cm (16 1/2"), Straight
PRO-15-735-02	42 cm (16 1/2"), Down
PRO-15-735-03	42 cm (16 1/2"), Straight
PRO-15-735-04	42 cm (16 1/2"), Down
PRO-15-735-05	42 cm (16 1/2"), Straight