



**PRECISION**<sup>™</sup>  
SURGICAL WORKS

## LIVER, GALL BLADDER, KIDNEY, UROLOGY

Leber, Galle, Niere, Urologie

Higado, Biliares, Renales, Urología

Foie, Biliaire, Rénaux, Urologie

Fegato, Biliari, Renali, Urologia



**Vasectomy Dissecting Forcep**

Catalog #	Size
PRO-14-011-01	Standard



**Vasectomy Fixation Clamp**

Catalog #	Size
PRO-14-014-02	Standard

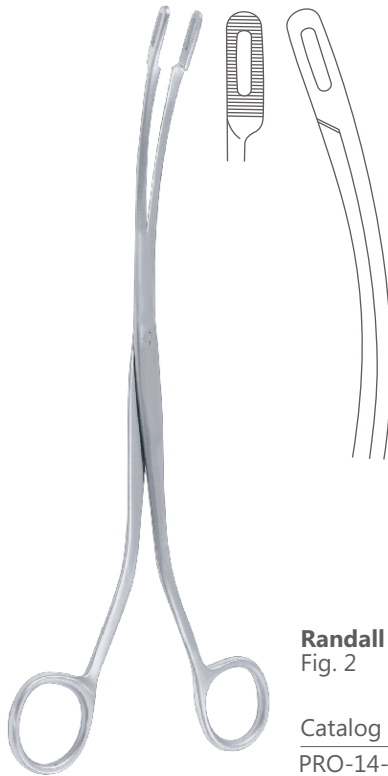

**Randall Kidney Stone Forcep**  
Fig. 1

Catalog #	Size
PRO-14-051-23	23 cm (9")

**Randall Kidney Stone Forcep**  
Fig. 2

Catalog #	Size
PRO-14-053-21	21 cm (8 ¼")

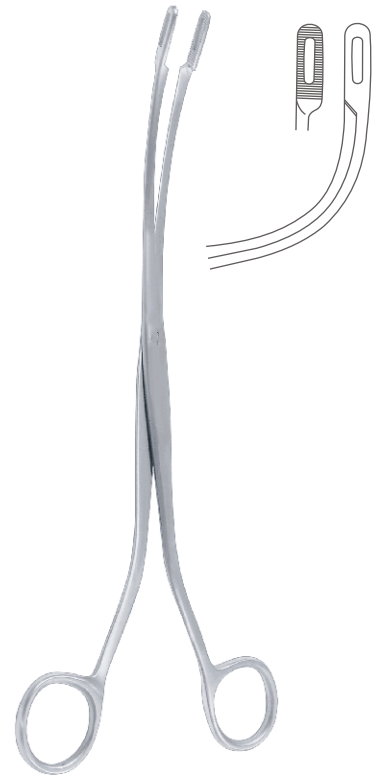

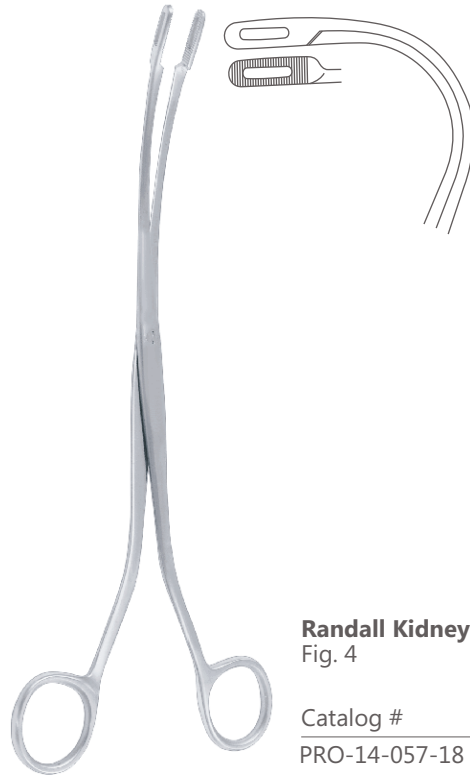

**Randall Kidney Stone Forcep**  
Fig. 3

Catalog #	Size
PRO-14-055-19	19 cm (7 ½")

**Randall Kidney Stone Forcep**  
Fig. 4

Catalog #	Size
PRO-14-057-18	18.5 cm (7 ½")



**Randall Kidney Stone Forcep**  
Fig. 5

Catalog #	Size
PRO-14-059-19	19 cm (7 ½")

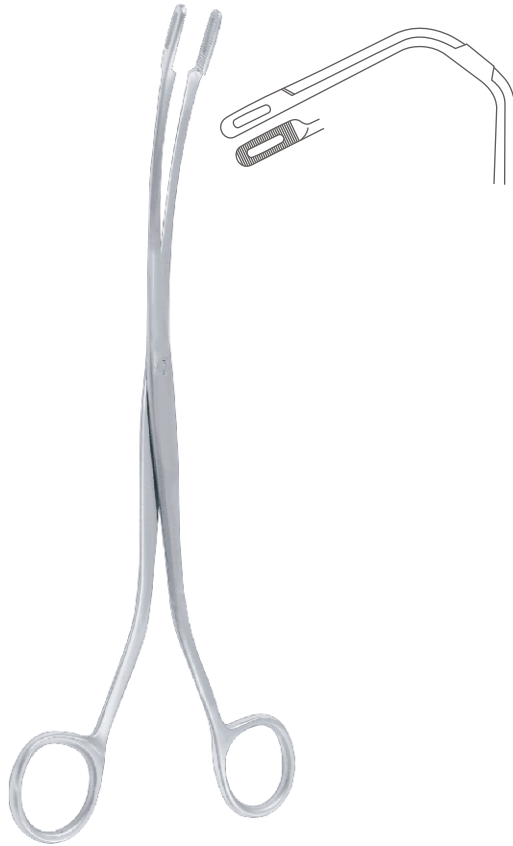

**Randall Kidney Stone Forcep**  
Fig. 6

Catalog #	Size
PRO-14-061-19	19 cm (7 ½")

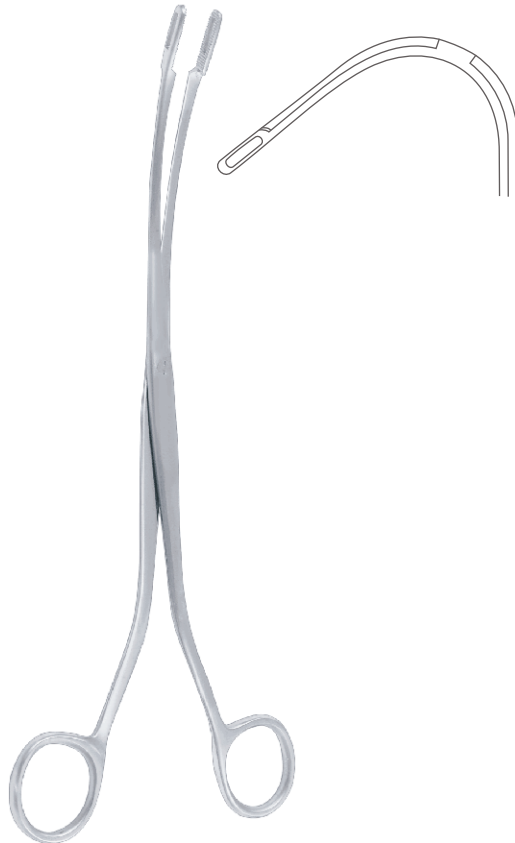

**Randall Kidney Stone Forcep**  
Fig. 1, Slender Pattern

Catalog #	Size
PRO-14-071-23	23 cm (9")



**Randall Kidney Stone Forcep**  
Fig. 2, Slender Pattern

Catalog #	Size
PRO-14-073-24	24 cm (9 ½")



**Heiming Kidney Stone Forcep**  
Fig. 1

Catalog #	Size
PRO-14-081-16	16 cm (6 ¼")



**Heiming Kidney Stone Forcep**  
Fig. 2

Catalog #	Size
PRO-14-083-17	17 cm (6 3/4")

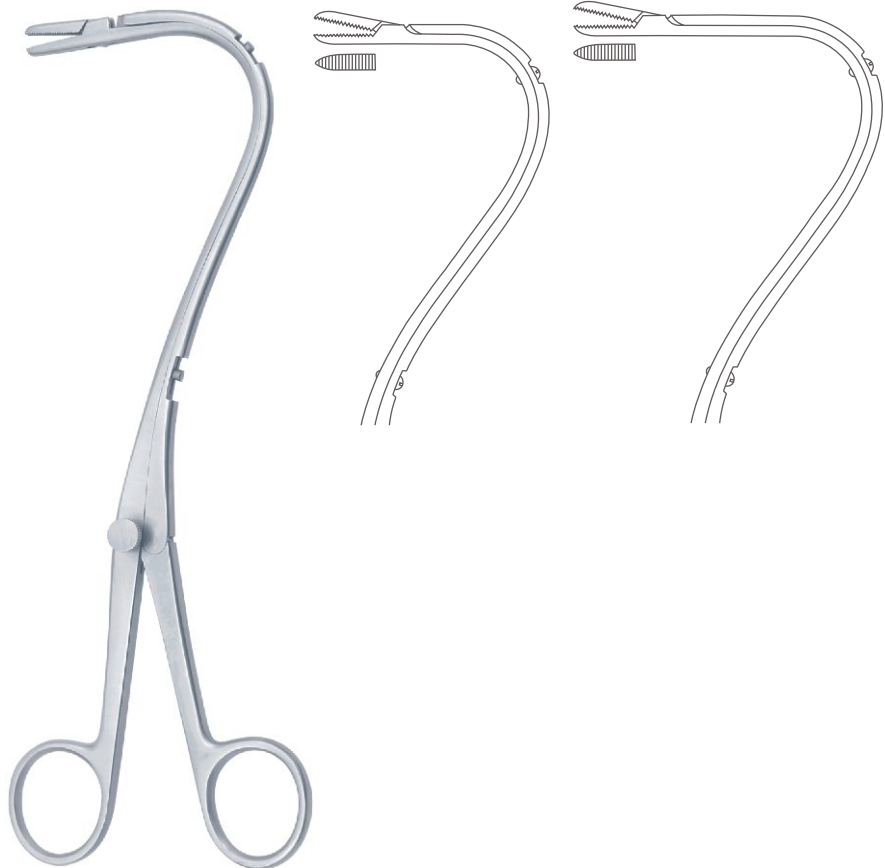

**Elsaesser Nephrectomy Forcep**

Catalog #	Size, Profile
PRO-14-091-01	21 cm (8 1/4"), Fig. 1
PRO-14-091-02	21 cm (8 1/4"), Fig. 2



**Bakes Gall Duct Dilators**

Catalog #	Size
PRO-14-150-00	Standard

**Bakes Gall Duct Dilator**

Catalog #	Size, Diameter, Profile
PRO-14-150-01	32 cm (12 1/2"), Ø 1 mm, Fig. 1
PRO-14-150-02	32 cm (12 1/2"), Ø 2 mm, Fig. 2
PRO-14-150-03	32 cm (12 1/2"), Ø 3 mm, Fig. 3
PRO-14-150-04	32 cm (12 1/2"), Ø 8 mm, Fig. 4
PRO-14-150-05	32 cm (12 1/2"), Ø 6 mm, Fig. 5
PRO-14-150-06	32 cm (12 1/2"), Ø 7 mm, Fig. 6
PRO-14-150-07	32 cm (12 1/2"), Ø 8 mm, Fig. 7
PRO-14-150-08	32 cm (12 1/2"), Ø 9 mm, Fig. 8
PRO-14-150-09	32 cm (12 1/2"), Ø 10 mm, Fig. 9
PRO-14-150-10	32 cm (12 1/2"), Ø 11 mm, Fig. 10
PRO-14-150-11	32 cm (12 1/2"), Ø 12 mm, Fig. 11
PRO-14-150-12	32 cm (12 1/2"), Ø 13 mm, Fig. 12
PRO-14-150-13	32 cm (12 1/2"), Ø 13 mm, Fig. 13

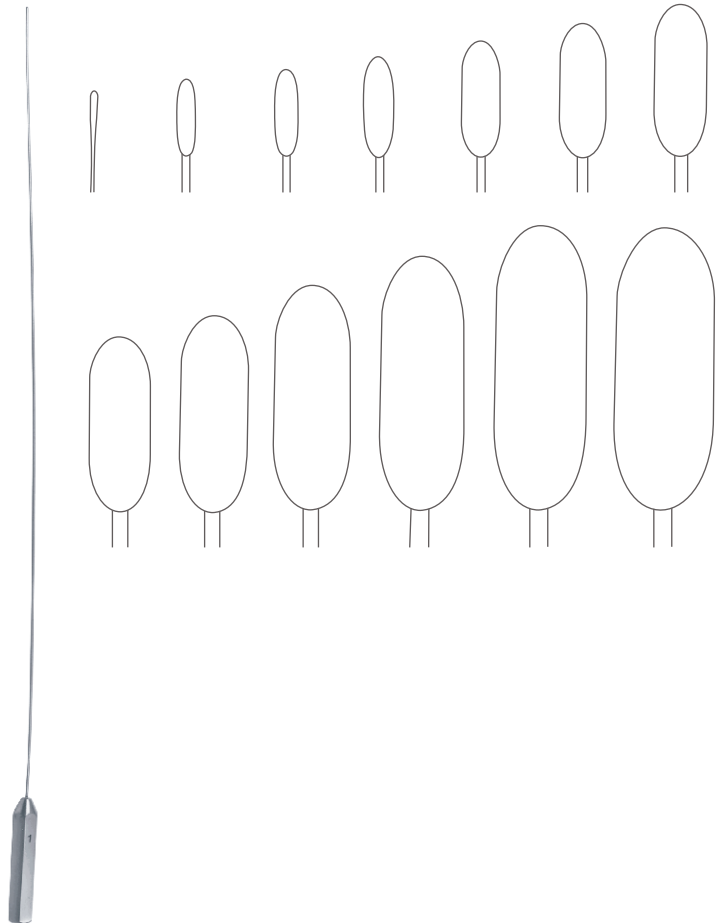



**Bakes Gall Stone Forcep**  
Straight

Catalog #	Size
PRO-14-180-20	21 cm (8 ¼")

**Bakes Gall Stone Forcep**  
Curved

Catalog #	Size
PRO-14-181-20	21 cm (8 ¼")



**Mayo-Bakes Gall Stone Forcep**  
Straight

Catalog #	Size
PRO-14-184-20	21 cm (8 ¼")

**Mayo-Bakes Gall Stone Forcep**  
Curved

Catalog #	Size
PRO-14-185-20	21 cm (8 ¼")







**Mixer Gall Stone Forcep**

Catalog #	Size
PRO-14-189-22	22 cm (8 ¾")

**Desjardins Gall Stone Forcep**  
Fig. 1

Catalog #	Size
PRO-14-191-23	23 cm (9")



**Desjardins Gall Stone Forcep**  
Fig. 2

Catalog #	Size
PRO-14-193-23	23 cm (9")

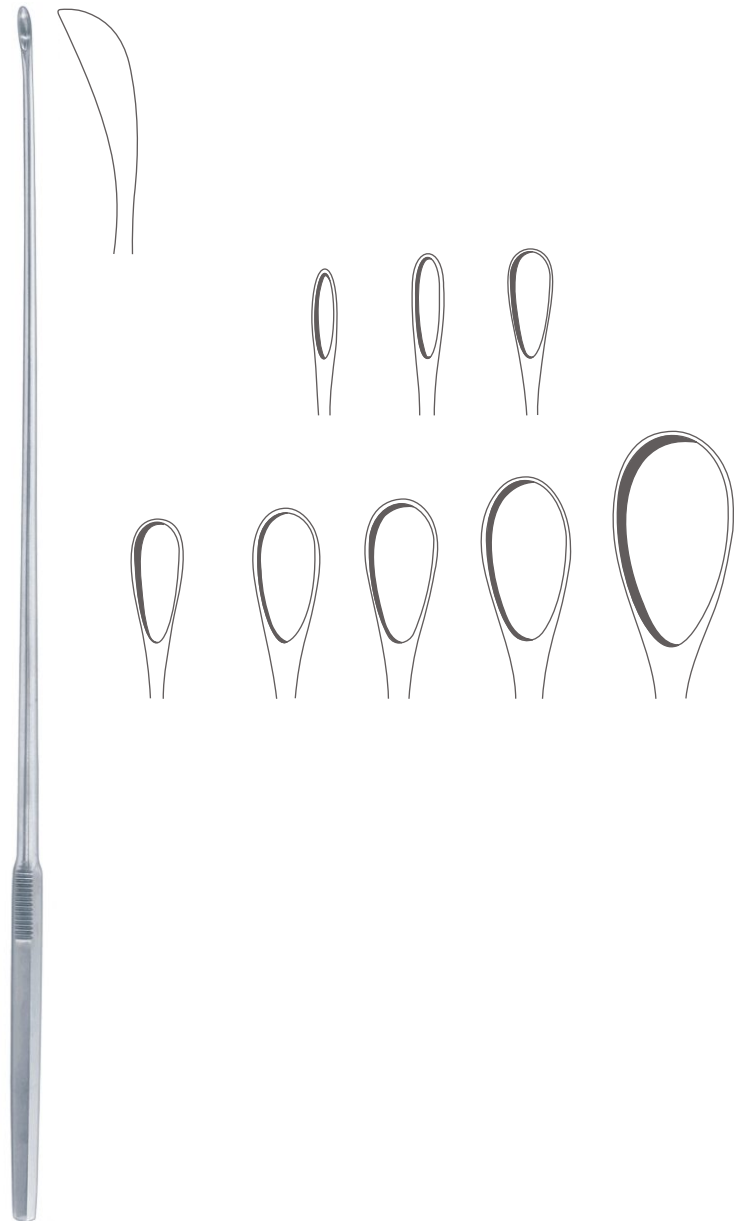

**Luer-Koerte Gall Stone Scoop**

Catalog #	Size, Scoop Size, Profile
PRO-14-250-01	32 cm (12 ½"), Ø 2.7 mm, Fig. 000
PRO-14-250-02	32 cm (12 ½"), Ø 3.4 mm, Fig. 00
PRO-14-250-03	32 cm (12 ½"), Ø 4.3 mm, Fig. 0
PRO-14-250-04	32 cm (12 ½"), Ø 5.5 mm, Fig. 1
PRO-14-250-05	32 cm (12 ½"), Ø 6.6 mm, Fig. 2
PRO-14-250-06	32 cm (12 ½"), Ø 8.0 mm, Fig. 3
PRO-14-250-07	32 cm (12 ½"), Ø 11.0 mm, Fig. 4
PRO-14-250-08	32 cm (12 ½"), Ø 15.0 mm, Fig. 5



**Young Prostatic Retractor**

Catalog #	Size
PRO-14-301-22	22 cm (8 ¾")



**Young Prostatic Retractor**

Catalog #	Size
PRO-14-305-21	21.5 cm (8 ½")

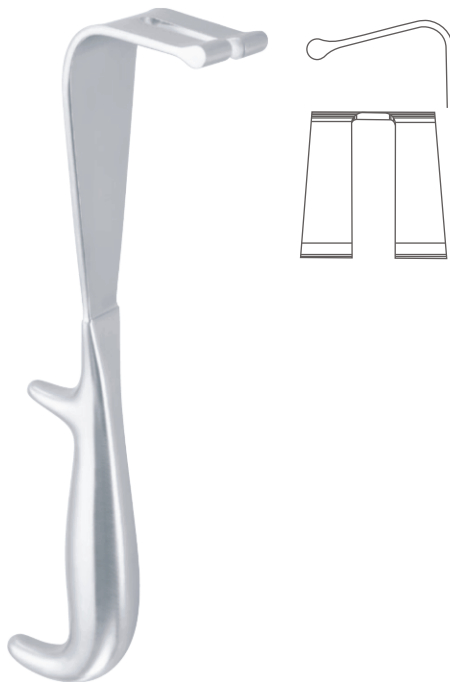

**Young Prostatic Retractor**

Catalog #	Size
PRO-14-309-23	23 cm (9")



**Millin Atrauma Capsule Forcep**

Catalog #	Size
PRO-14-451-24	24.5 cm (9 ½")

**Millin Atrauma Capsule Forcep**

Catalog #	Size
PRO-14-453-22	22.5 cm (8 ¾")

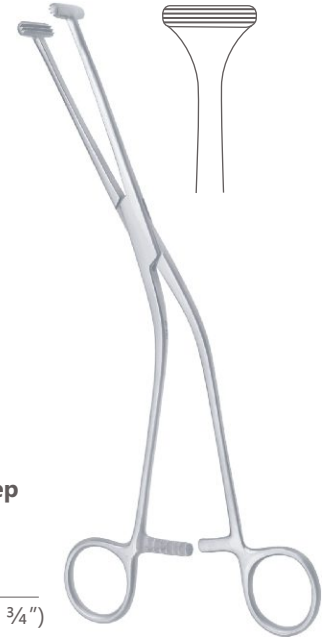

**Millin Capsule Forcep**

Catalog #	Size
PRO-14-457-24	24.5 cm (9 ½")

**Millin Capsule Forcep**

Catalog #	Size
PRO-14-461-22	22 cm (8 ¾")





**Van Buren Urethral Sound / Dilating Bougie**

Catalog #	Size
PRO-14-501-00	Standard

**Van Buren Urethral Sound / Dilating Bougie**

Catalog #	Size, Profile
PRO-14-501-08	27 cm (10 3/4"), 8 Charr.
PRO-14-501-10	27 cm (10 3/4"), 10 Charr.
PRO-14-501-12	27 cm (10 3/4"), 12 Charr.
PRO-14-501-14	27 cm (10 3/4"), 14 Charr.
PRO-14-501-16	27 cm (10 3/4"), 16 Charr.
PRO-14-501-18	27 cm (10 3/4"), 18 Charr.
PRO-14-501-20	27 cm (10 3/4"), 20 Charr.
PRO-14-501-22	27 cm (10 3/4"), 22 Charr.
PRO-14-501-24	27 cm (10 3/4"), 24 Charr.
PRO-14-501-26	27 cm (10 3/4"), 26 Charr.
PRO-14-501-28	27 cm (10 3/4"), 28 Charr.
PRO-14-501-30	27 cm (10 3/4"), 30 Charr.
PRO-14-501-32?	27 cm (10 3/4"), 32 Charr.?
PRO-14-501-34	27 cm (10 3/4"), 34 Charr.
PRO-14-501-36	27 cm (10 3/4"), 36 Charr.



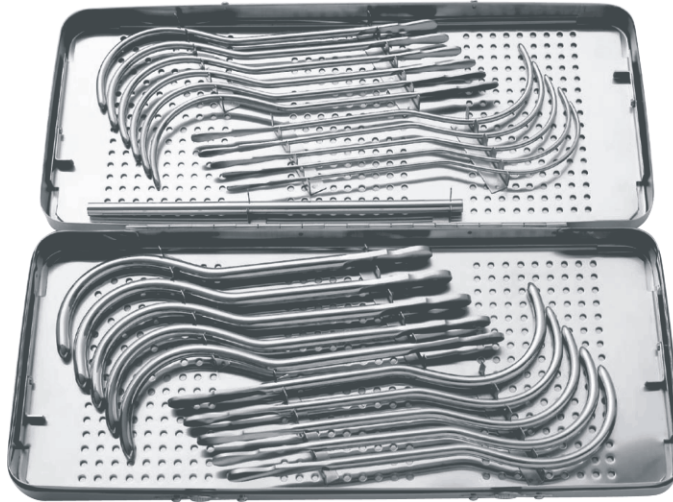

**Guyon Urethral Sound / Dilating Bougie**  
Set of 24 in Metal Case

Catalog #	Size
PRO-14-511-00	Standard

**Guyon Urethral Sound / Dilating Bougie**

Catalog #	Size, Profile
PRO-14-511-10	26.5 cm (10 1/2"), 10 Charr.
PRO-14-511-11	26.5 cm (10 1/2"), 11 Charr.
PRO-14-511-12	26.5 cm (10 1/2"), 12 Charr.
PRO-14-511-13	26.5 cm (10 1/2"), 13 Charr.
PRO-14-511-14	26.5 cm (10 1/2"), 14 Charr.
PRO-14-511-15	26.5 cm (10 1/2"), 15 Charr.
PRO-14-511-16	26.5 cm (10 1/2"), 16 Charr.
PRO-14-511-17	26.5 cm (10 1/2"), 17 Charr.
PRO-14-511-18?	26.5 cm (10 1/2"), 18 Charr.
PRO-14-511-19	26.5 cm (10 1/2"), 19 Charr.
PRO-14-511-20	26.5 cm (10 1/2"), 20 Charr.
PRO-14-511-21	26.5 cm (10 1/2"), 21 Charr.
PRO-14-511-22	26.5 cm (10 1/2"), 22 Charr.
PRO-14-511-23	26.5 cm (10 1/2"), 23 Charr.
PRO-14-511-24	26.5 cm (10 1/2"), 24 Charr.
PRO-14-511-25	26.5 cm (10 1/2"), 25 Charr.
PRO-14-511-26	26.5 cm (10 1/2"), 26 Charr.
PRO-14-511-27	26.5 cm (10 1/2"), 27 Charr.
PRO-14-511-28	26.5 cm (10 1/2"), 28 Charr.
PRO-14-511-30	26.5 cm (10 1/2"), 30 Charr.



**Female Catheter**

Catalog #	Size, Profile
PRO-14-515-10	15 cm (6"), 10 Charr.
PRO-14-515-12	15 cm (6"), 12 Charr.
PRO-14-515-14	15 cm (6"), 14 Charr.
PRO-14-515-16	15 cm (6"), 16 Charr.
PRO-14-515-18	15 cm (6"), 18 Charr.
PRO-14-515-20	15 cm (6"), 20 Charr.



**Catheter Introducer**

Catalog #	Size
PRO-14-519-00	46 cm (18")



**Otis Urethrotome**  
With 2 Knives and 3 Tips

Catalog #	Size
PRO-14-550-00	Standard



**Otis Spare Blade**

Catalog #	Size
PRO-14-550-01	Standard

**Filiform Urethral Sound / Dilating Bougie**

Catalog #	Profile
PRO-14-580-03	3 Charr.
PRO-14-580-04	4 Charr.
PRO-14-580-05	5 Charr.
PRO-14-580-06	6 Charr.

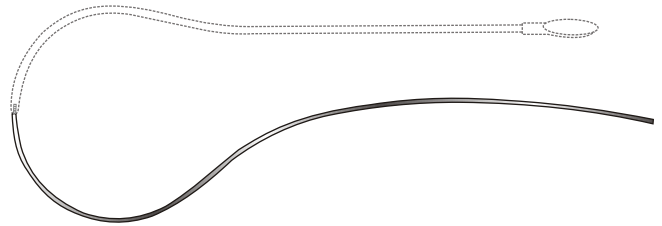

**Knutson Urethrography Instrument**

Catalog #	Size
PRO-14-700-00	Standard





**Gomco Circumcision Clamp**

Catalog #	Diameter
PRO-14-720-08	Ø 8 mm
PRO-14-720-11	Ø 11 mm
PRO-14-720-13	Ø 13 mm
PRO-14-720-16	Ø 16 mm
PRO-14-720-21	Ø 21 mm
PRO-14-720-26	Ø 26 mm
PRO-14-720-32	Ø 32 mm

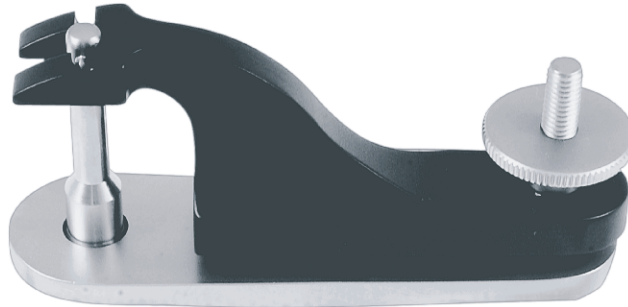

**Mogen Circumcision Clamp**

Catalog #	Size
PRO-14-740-00	7.5 cm (3")

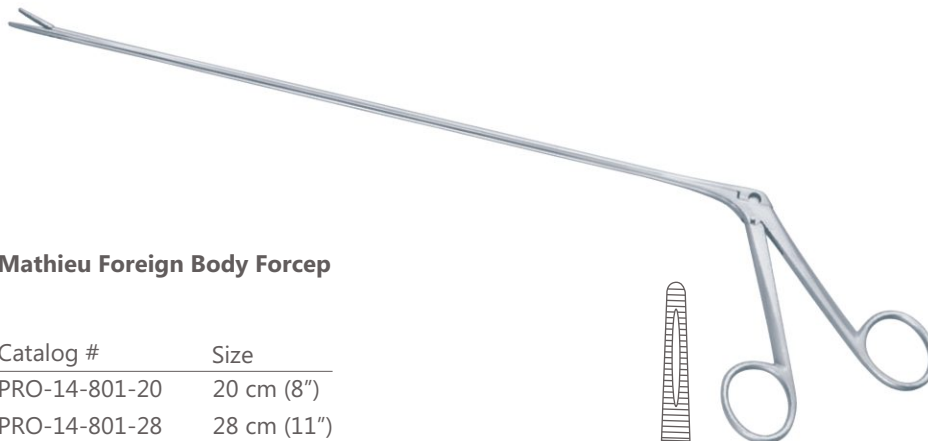

**Mathieu Foreign Body Forcep**

Catalog #	Size
PRO-14-801-20	20 cm (8")
PRO-14-801-28	28 cm (11")

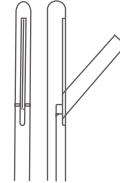

**Sachse Meatotome**

Catalog #	Size
PRO-14-815-12	Standard

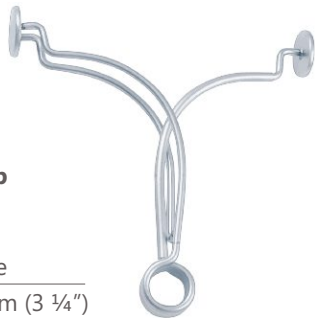

**Stockman Penis Clamp**

Catalog #	Size
PRO-14-851-08	8 cm (3 1/4")



**Strauss Penis Clamp**

Catalog #	Size
PRO-14-861-11	11 cm (4 1/2")



**Collingwood-Stewart Hernia Ring Forcep**

Catalog #	Size
PRO-14-870-13	13 cm (5")