



The Choice of Professionals



Oral, Maxillofacial and ENT Surgery Instruments Catalogue

EDITION 2019



Web: www.precisionurgicalworks.com E-mail: sales@precisionurgicalworks.com

- **Introduction to the Catalogue**

Thank you for your interest in Precision Oral, Maxillofacial and ENT Instruments. We remain committed to providing the highest quality products and customer service.

In this special catalogue you will find a comprehensive range of Oral, Maxillofacial and ENT Instruments, which have been developed following detailed consultation with leading Oral, Maxillofacial and ENT surgeons. These instruments in conjunction with Precision General Instruments provides complete solution for oral, maxillofacial, otology, rhinology, rhinoplasty, tonsillectomy and tracheotomy surgeries.

We appreciate your patronage and look forward to a successful relationship with you.

- **About Precision Instruments**

Precision Instruments is a privately owned medical technology company dedicated to innovation and excellence in the crafting of dental & surgical instruments. Based on customer demand over time our roots extended beyond a specialist in reconstructive surgery instruments and gradually expanded to one of the most comprehensive instrument range available in the industry today.

- **Why is Precision Focused on Instruments Quality?**

Surgeons are highly talented and skilled individuals. They operate under significant time constraints and are required to make quick decisions while performing complex dental & surgical surgeries. At Densty we understand that in such a scenario the dental & surgical professional requires tools that are not just fit for the purpose but are reliable, dependable and crafted by a company that has track record for relentless pursuit for excellence in the manufacturing of dental & surgical instruments.

- **Precision Quality Standards**

In European Union medical devices are subject to a series of uniform laws and the EC directive places rigid demands on surgical instruments. Precision Instruments is proud to claim that we have always surpassed the legal requirements to ensure that each instrument reaching the surgeons hand is indeed a testament to surgical craftsmanship.

We are BS EN ISO 13485:2012/ISO 9001:2008 certified and CE approved to ensure compliance with the standard defined in line with medical devices directive 93/42/EEC.

- **Life Time Warranty**

We encourage our customers to calculate lifetime costs prior to making purchase decisions and investing in surgical instruments.

Precision Instruments are guaranteed for life* against manufacturing defects of material and workmanship. This means we will repair or replace free of charge any surgical instrument that does not meet its functional requirements when used for its intended purpose and maintained properly.

■ MEASUREMENTS, STANDARDS, AND CONVERSIONS

Millimeter Equivalents

MM = INCHES	MM = INCHES	MM = INCHES
.1 = .00384	29.0 = 1.14173	65.0 = 2.55905
.2 = .00787	30.0 = 1.18110	66.0 = 2.59842
.3 = .01181	31.0 = 1.22047	67.0 = 2.63779
.4 = .01575	32.0 = 1.25984	68.0 = 2.67716
.5 = .01968	33.0 = 1.29921	69.0 = 2.71653
.6 = .02362	34.0 = 1.33858	70.0 = 2.75590
.7 = .02756	35.0 = 1.37795	71.0 = 2.79527
.8 = .03149	36.0 = 1.41732	72.0 = 2.83464
.9 = .03543	37.0 = 1.45669	73.0 = 2.87401
1.0 = .03937	38.0 = 1.49606	74.0 = 2.91338
2.0 = .07874	38.1 = 1.5 in	75.0 = 2.95275
3.0 = .11811	39.0 = 1.53543	76.0 = 2.99212
4.0 = .15748	40.0 = 1.57480	76.2 = 3.0 in
5.0 = .19685	41.0 = 1.61417	77.0 = 3.03149
6.0 = .23622	42.0 = 1.65354	78.0 = 3.07056
7.0 = .27559	43.0 = 1.69291	79.0 = 3.11023
8.0 = .31496	44.0 = 1.73228	80.0 = 3.14960
9.0 = .35433	45.0 = 1.77165	81.0 = 3.18897
10.0 = .39370	46.0 = 1.81102	82.0 = 3.22834
11.0 = .43307	47.0 = 1.85039	83.0 = 3.26771
12.0 = .47244	48.0 = 1.88976	84.0 = 3.30708
12.7 = .5 in	49.0 = 1.92913	85.0 = 3.34645
13.0 = .51181	50.0 = 1.96350	86.0 = 3.38582
14.0 = .55118	50.8 = 2.0 in	87.0 = 3.42519
15.0 = .59055	51.0 = 2.00787	88.0 = 3.46456
16.0 = .62992	52.0 = 2.04724	88.9 = 3.5 in
17.0 = .66929	53.0 = 2.08661	89.0 = 3.50393
18.0 = .70866	54.0 = 2.12598	90.0 = 3.54330
19.0 = .74803	55.0 = 2.16535	91.0 = 3.58267
20.0 = .78740	56.0 = 2.20472	92.0 = 3.62204
21.0 = .82677	57.0 = 2.24409	93.0 = 3.66141
22.0 = .86614	58.0 = 2.28346	94.0 = 3.70078
23.0 = .90551	59.0 = 2.32283	95.0 = 3.74015
24.0 = .94488	60.0 = 2.36220	96.0 = 3.77952
25.0 = .98425	61.0 = 2.40157	97.0 = 3.81889
25.4 = 1.0 in	62.0 = 2.44094	98.0 = 3.85826
26.0 = 1.02362	63.0 = 2.48031	99.0 = 3.89763
27.0 = 1.06299	63.5 = 2.5 in	100.0 = 3.93700
28.0 = 1.10236	64.0 = 2.51968	101.6 = 4.0 in

Needle Tubing Equivalents

SIZE GAUGE NO.	APPROX. O.D. MM INCHES
26	0.4 .018
24	0.5 .022
22	0.7 .028
20	0.9 .035
18	1.3 .053
16	1.6 .065
14	2.1 .083
12	2.8 .109
10	3.4 .134
8	4.2 .165
6	5.1 .203

Suction Tubing Equivalents

SIZE FRENCH GAUGE NO.	APPROX. O.D. MM INCHES
3	1.0 .039
4	1.3 .053
5	1.7 .066
6	2.0 .079
7	2.3 .092
8	2.7 .105
9	3.0 .118
10	3.3 .131
11	3.7 .144
12	4.0 .158
13	4.3 .170
14	4.7 .184
15	5.0 .197
16	5.3 .210

TABLE OF INDEX

01	Oral Maxillo-Facial Surgery	1 - 29
02	Otology Instruments	30 - 80
03	Rhinology Instruments	81 - 134
04	Tonsillectomy, Laryngo-bronchoscopy	135 - 152



PRECISION[™]
SURGICAL WORKS

ORAL MAXILLO-FACIAL SURGERY

Mund-, Kiefer- und Gesichtschirurgie

Cirugía oral y maxilofacial

Chirurgie buccale et maxillo-faciale

Chirurgia maxillo-facciale

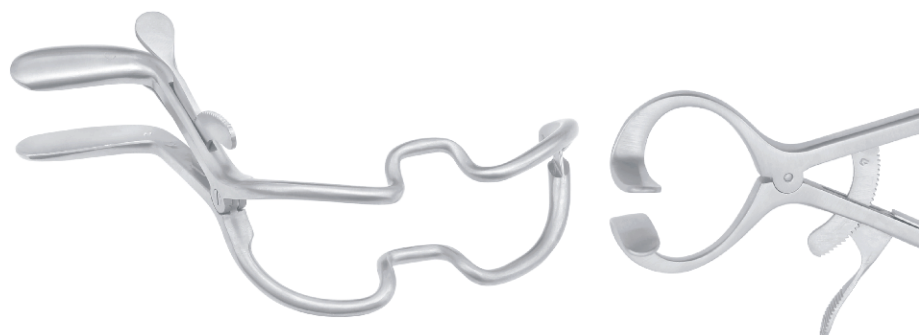



Adams Napkin Holder

Consisting of Chain and Two Crocodile Forceps

Catalog #	Size
PRO-22-011-01	Standard



Langenbeck Finger Protector

Catalog #	Diameter
PRO-22-015-01	Ø 18.0 mm
PRO-22-015-02	Ø 21.0 mm
PRO-22-015-03	Ø 22.0 mm

Maunder Mouth Gag
Wood

Catalog #	Size
PRO-22-018-10	Standard



Heister Mouth Gag

Catalog #	Size
PRO-22-030-13	13 cm (5")

Obwegeser Mouth Gag

Catalog #	Size
PRO-22-032-11	11 cm (4 1/4")



Molt Mouth Gag

Catalog #	Size
PRO-22-035-11	11 cm (4 1/4")
PRO-22-035-14	13 cm (5")



Denhart Mouth Gag

Catalog #	Size, Jaw Size
PRO-22-039-12	13 cm (5"), 16 mm



Roser-Koenig Mouth Gag

Catalog #	Size
PRO-22-041-16	16 cm (6 1/4")
PRO-22-041-20	20 cm (8")

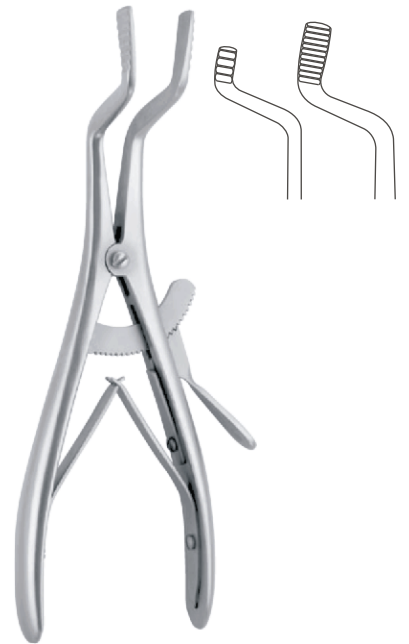



Fergusson-Ackland Mouth Gag

Catalog #	Size
PRO-22-043-18	14.5 cm (5 ¾")
PRO-22-043-20	18 cm (7")

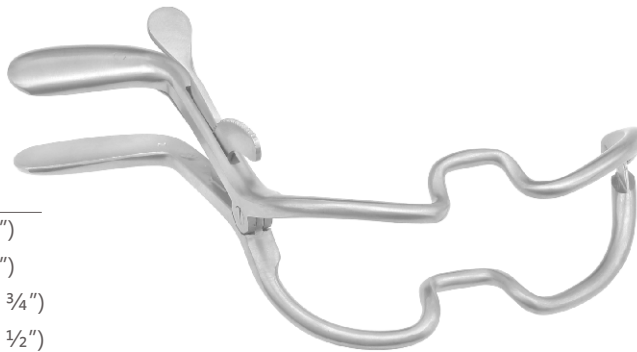

Jennings Mouth Gag

Catalog #	Size
PRO-22-047-09	10.5 cm (4")
PRO-22-047-11	12.5 cm (5")
PRO-22-047-13	14.5 cm (5 ¾")
PRO-22-047-15	16.5 cm (6 ½")

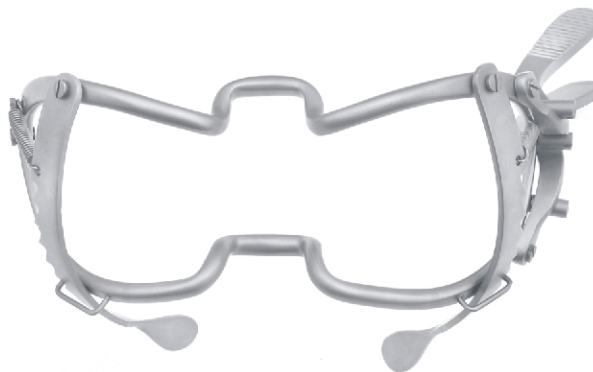

Whitehead Mouth Gag

Without Tongue Depressor Ratchet

Catalog #	Size
PRO-22-049-11	11 cm (4 ¼")
PRO-22-049-13	13 cm (5")
PRO-22-049-15	15 cm (6")

Whitehead Mouth Gag
With Tongue Depressor Ratchet

Catalog #	Size
PRO-22-051-13	13 cm (5")



Negus Chest Support for Mouth Gag

Catalog #	Size
PRO-22-058-00	20 cm (8")



Kilner-Doughty Mouth Gag Complete
With 3 Tongue Depressors

Catalog #	Size
PRO-22-060-00	Standard



Kilner-Doughty Mouth Gag
Frame Only

Catalog #	Size
PRO-22-061-00	14.5 cm (5 3/4")



Kilner-Doughty Tongue Depressor
Fenestrated Blade for Suction



Catalog #	Size, Blade Size
PRO-22-063-01	13.5 cm (5 1/4"), 70 x 29 mm
PRO-22-063-02	13.5 cm (5 1/4"), 80 x 34 mm
PRO-22-063-03	13.5 cm (5 1/4"), 85 x 38 mm

Davis-Boyle Mouth Gag Complete
With 5 Tongue Depressors

Catalog #	Size
PRO-22-070-00	Standard



Davis-Boyle Mouth Gag
Frame Only

Catalog #	Size
PRO-22-071-00	Standard



Davis-Boyle Tongue Depressor
With Fixed Suction Tube

Catalog #	Size, Blade Size
PRO-22-073-01	13.5 cm (5 1/4"), 100 x 26 mm
PRO-22-073-02	13.5 cm (5 1/4"), 100 x 26 mm
PRO-22-073-03	13.5 cm (5 1/4"), 100 x 26 mm
PRO-22-073-04	13.5 cm (5 1/4"), 100 x 26 mm





Davis-Boyle Tongue Depressor
With Suction Tube

Catalog #	Size, Blade Size
PRO-22-073-05	13.5 cm (5 ¼"), 30 x 20 mm



McIvor Mouth Gag Complete
With 3 Tongue Depressors

Catalog #	Size
PRO-22-080-00	Standard



McIvor Mouth Gag
Frame Only

Catalog #	Size
PRO-22-081-00	15 cm (6")



McIvor Tongue Depressor

Catalog #	Size, Blade Size
PRO-22-083-01	13.5 cm (5 ¼"), 100 x 26 mm
PRO-22-083-02	13.5 cm (5 ¼"), 85 x 25 mm
PRO-22-083-03	13.5 cm (5 ¼"), 75 x 23 mm

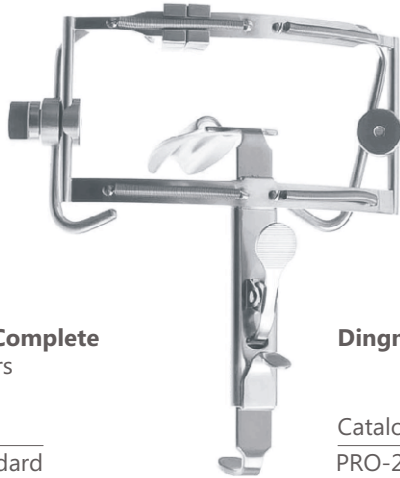

Dingmann Mouth Gag Complete
With 3 Tongue Depressors

Catalog #	Size
PRO-22-090-00	Standard

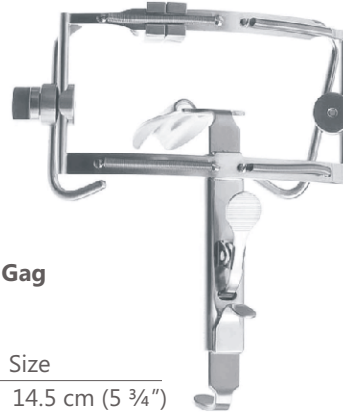

Dingmann Mouth Gag

Catalog #	Size
PRO-22-091-00	14.5 cm (5 ¾")



Dingmann Tongue Depressor

Catalog #	Size, Blade Size
PRO-22-093-01	13.5 cm (5 ¼"), 65 x 25 mm
PRO-22-093-02	13.5 cm (5 ¼"), 70 x 29 mm
PRO-22-093-03	13.5 cm (5 ¼"), 80 x 32 mm

Negus Tongue Depressor

Catalog #	Size, Blade Size
PRO-22-097-01	13.5 cm (5 ¼"), 70 x 20 mm
PRO-22-097-02	13.5 cm (5 ¼"), 80 x 30 mm
PRO-22-097-03	13.5 cm (5 ¼"), 95 x 35 mm



Draffin Bipod Complete
With 2 Draffin Bipod Rod

Catalog #	Size
PRO-22-100-00	Standard

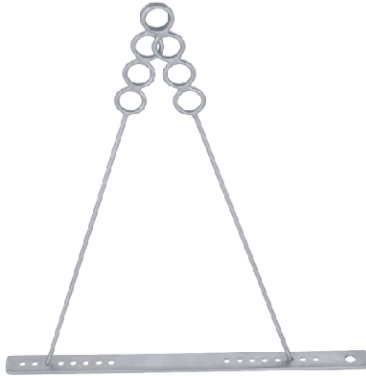

Maguaran Plate
For Holding Draffin Bipod

Catalog #	Size
PRO-22-100-01	40 cm (15 3/4")

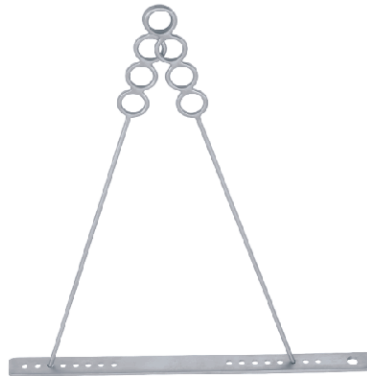

Draffin Biopod Rod
With 4 Rings for Varying Height

Catalog #	Size
PRO-22-100-48	48 cm (19")

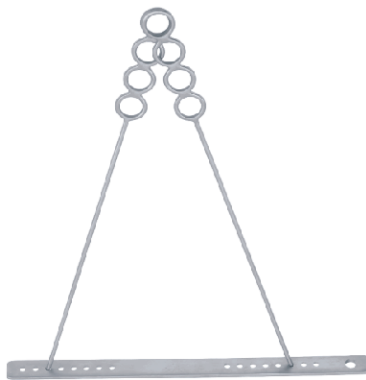

McKesson Mouth Prop

Catalog #	Profile
PRO-22-110-01	For Baby
PRO-22-110-02	For Child
PRO-22-110-03	For Adult
PRO-22-110-04	For Adult
PRO-22-110-05	For Edentulous

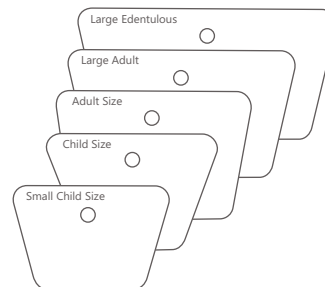
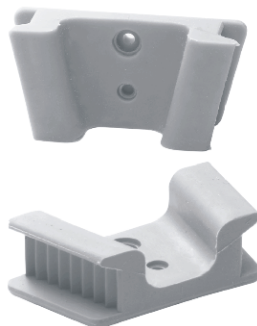



Martin-Simplex Lip and Cheek Retractor

Catalog #	Size
PRO-22-121-11	10 cm (4")

Obwegeser Lip and Cheek Retractor

Catalog #	Size
PRO-22-123-12	10 cm (4¾")

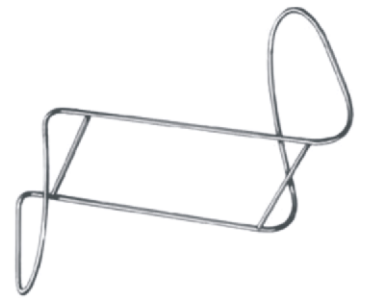

Bishop Lip and Cheek Retractor

Catalog #	Size, Blade Width
PRO-22-127-13	13.5 cm (5 ¼"), 27 mm

Cawood-Minnesota Cheek Retractor

Catalog #	Size, Blade Width
PRO-22-131-15	15 cm (6"), 20 mm





Minnesota Cheek Retractor

Catalog #	Size
PRO-22-135-14	14.5 cm (5 ¾")



Hartmann Tongue Depressor

Catalog #	Size, Blade Size
PRO-22-141-15	15 cm (6"), 72 x 23 mm



Tobold Tongue Depressor

Catalog #	Size, Blade Size
PRO-22-143-15	15 cm (6"), 88 x 25 mm



Andrew Tongue Depressor

Catalog #	Size
PRO-22-145-14	14.5 cm (5 ¾")



Wieder Tongue Depressor

Catalog #	Size, Blade Width
PRO-22-147-01	14 cm (5 ½"), 36 mm
PRO-22-147-02	15 cm (6"), 43 mm



Standard Tongue Depressor

Catalog #	Size
PRO-22-151-14	14.5 cm (5 ¾")



Kroenig Tongue Depressor

Catalog #	Size
PRO-22-153-15	15 cm (6")



Mayo Tongue Depressor

Catalog #	Size
PRO-22-155-17	17 cm (6 ¾")

Bruenings Tongue Depressor

Catalog #	Size, Blade Width 1 - Blade Width 2
PRO-22-159-19	19 cm (7 ½"), 19 mm - 15 mm



Colling Tongue Holding Forcep

Catalog #	Size, Jaw Size
PRO-22-170-17	17 cm (6 ¾"), 24 x 27 mm





Young Tongue Holding Forcep

Catalog #	Size
PRO-22-173-17	15 cm (6")

Henahan Retractor

Catalog #	Size, Profile
PRO-22-201-01	18 cm (7"), Fig. 1
PRO-22-201-02	18 cm (7"), Fig. 2
PRO-22-201-03	18 cm (7"), Fig. 3

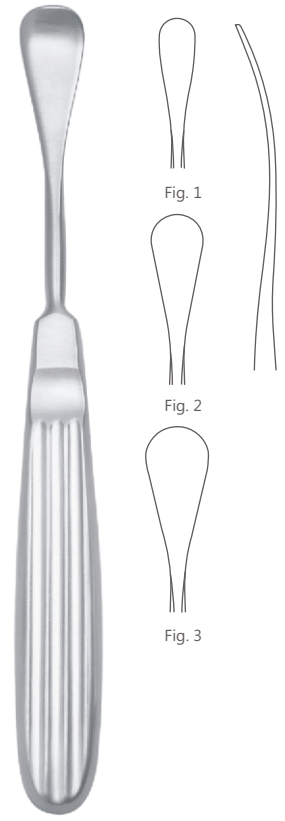

Sigmoid Notch Extra Oral Retractor
Concave Blade Full Bent Tip

Catalog #	Size, Blade Size
PRO-22-251-24	22 cm (8 3/4"), 9.5 mm x 16 mm



Petri Intra Oral Retractor
For LeFort Osteotomies

Catalog #	Size, Blade Width
PRO-22-255-24	23 cm (9"), 25.5 mm





Bauer Intra Oral Retractor
Left

Catalog #	Size
PRO-22-259-21	21 cm (8 ¼")



Bauer Intra Oral Retractor
Right

Catalog #	Size
PRO-22-261-21	21 cm (8 ¼")



Levasseur-Merrill Intra Oral Retractor

Catalog #	Size
PRO-22-265-25	25 cm (9 ¾")

Obwegeser Soft Tissue Retractor
Bent Upwards

Catalog #	Size, Blade Size
PRO-22-271-16	24 cm (9 ½"), 5 x 16 mm
PRO-22-271-25	24 cm (9 ½"), 7 x 25 mm
PRO-22-271-35	24 cm (9 ½"), 10 x 35 mm
PRO-22-271-42	24 cm (9 ½"), 10 x 42 mm
PRO-22-271-55	24 cm (9 ½"), 12 x 55 mm
PRO-22-271-70	24 cm (9 ½"), 14 x 70 mm
PRO-22-271-80	24 cm (9 ½"), 16 x 80 mm

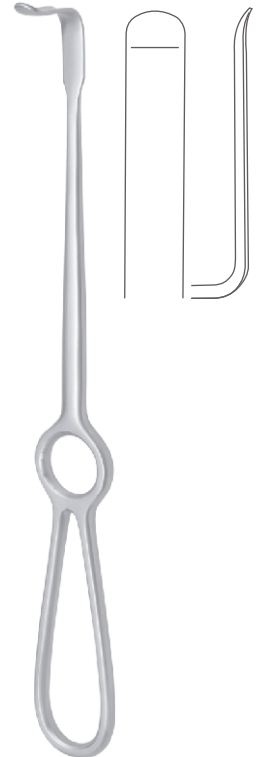

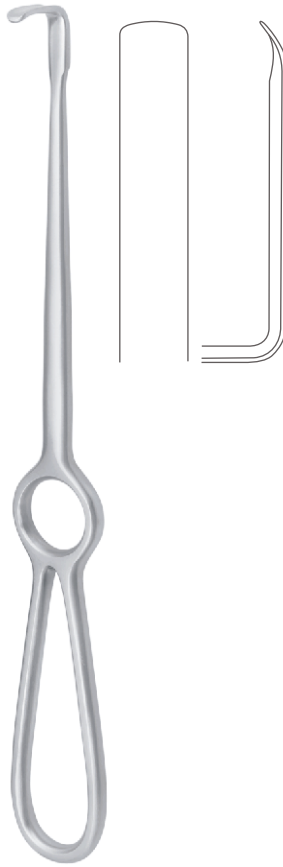

Obwegeser Soft Tissue Retractor
Bent Downwards

Catalog #	Size, Blade Size
PRO-22-273-16	24 cm (9 ½"), 5 x 16 mm
PRO-22-273-25	24 cm (9 ½"), 7 x 25 mm
PRO-22-273-35	24 cm (9 ½"), 10 x 35 mm
PRO-22-273-42	24 cm (9 ½"), 10 x 42 mm
PRO-22-273-55	24 cm (9 ½"), 12 x 55 mm
PRO-22-273-70	24 cm (9 ½"), 14 x 70 mm
PRO-22-273-80	24 cm (9 ½"), 16 x 80 mm

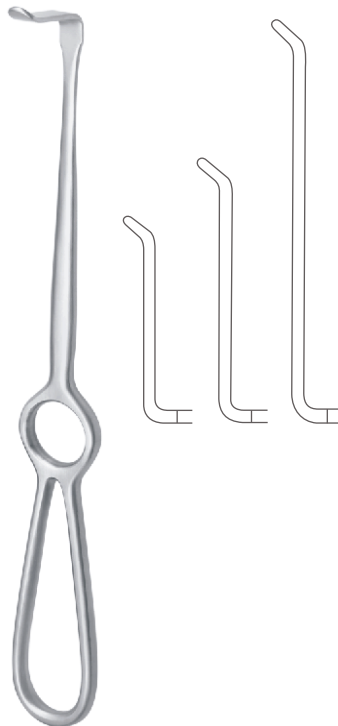

Obwegeser Soft Tissue Retractor
Bent Upwards

Catalog #	Size, Blade Size
PRO-22-275-43	21.5 cm (8 ½"), 11 x 43 mm
PRO-22-275-57	21.5 cm (8 ½"), 11 x 57 mm
PRO-22-275-83	21.5 cm (8 ½"), 16 x 83 mm



Obwegeser Mandibular Retractor

Catalog #	Size, Blade Size
PRO-22-279-30	21 cm (8 ¼"), 12 x 30 mm
PRO-22-279-45	21 cm (8 ¼"), 12 x 45 mm
PRO-22-279-60	21 cm (8 ¼"), 12 x 60 mm

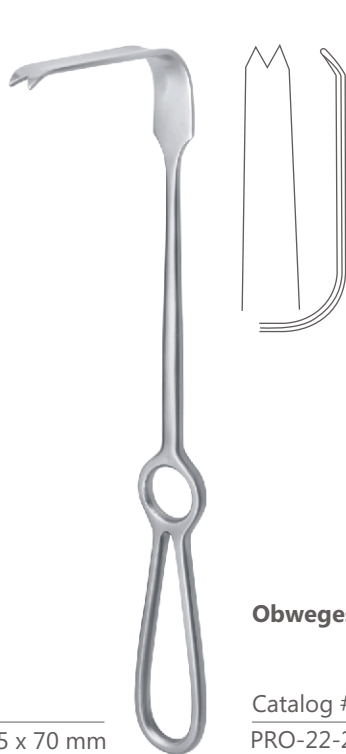

Obwegeser Ramus Retractor

Catalog #	Size, Blade Size
PRO-22-281-22	24.5 cm (9 ¾"), 15 x 70 mm

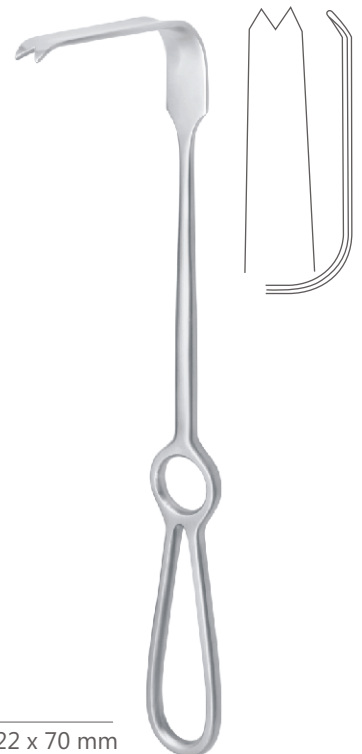

Obwegeser Ramus Retractor

Catalog #	Size, Blade Size
PRO-22-283-22	24.5 cm (9 ¾"), 22 x 70 mm



Obwegeser Ramus Retractor (Nasal Spine Retractor)

Catalog #	Size, Blade Size
PRO-22-287-22	22 cm (8 ¾"), 45 x 10 mm

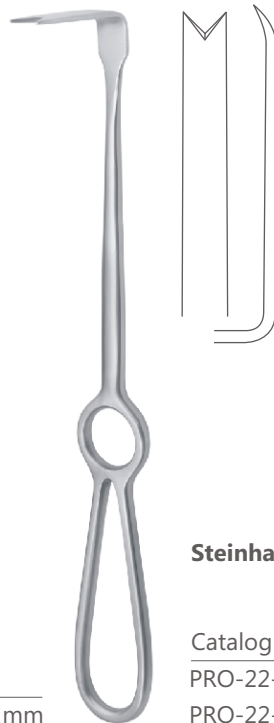

Obwegeser Ramus Retractor

Catalog #	Size, Blade Size
PRO-22-289-22	22 cm (8 ¾"), 72 x 10 mm

Steinhauser Zygomatic Retractor

Catalog #	Size, Profile
PRO-22-291-01	24 cm (9 ½"), Right
PRO-22-291-02	24 cm (9 ½"), Left

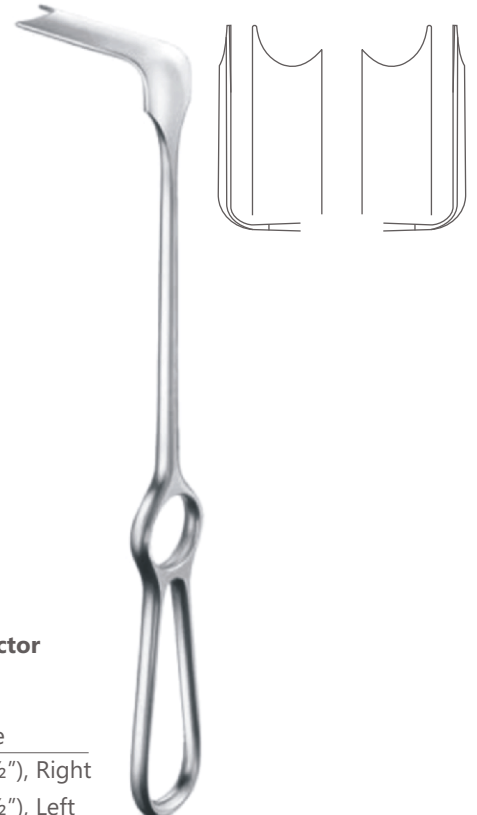



Obwegeser Chin Retractor

Catalog #	Size
PRO-22-301-16	16.5 cm (6 1/2")

Obwegeser Channel Retractor

Catalog #	Size, Blade Width
PRO-22-305-08	17 cm (6 3/4"), 8 mm
PRO-22-305-10	17 cm (6 3/4"), 10 mm



Hargis Medial Ramus Retractor

Catalog #	Size, Profile
PRO-22-315-01	19.5 cm (7 3/4"), Right
PRO-22-315-02	19.5 cm (7 3/4"), Left



Hargis Mandibular Body Retractor

Catalog #	Size
PRO-22-319-18	18 cm (7")



Hargis Anterior Border Stripper

Catalog #	Size
PRO-22-331-19	19 cm (7 1/2")



Obwegeser Periosteal Elevator

Catalog #	Size, Blade Width
PRO-22-361-04	17.5 cm (7"), 4 mm
PRO-22-361-06	17.5 cm (7"), 6 mm
PRO-22-361-07	17.5 cm (7"), 7 mm
PRO-22-361-09	17.5 cm (7"), 9 mm
PRO-22-361-11	17.5 cm (7"), 11 mm

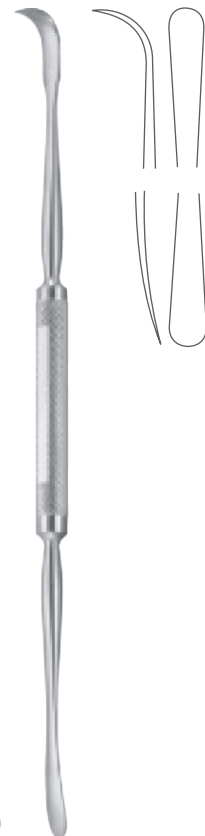

Obwegeser Elevator
Fig. 1

Catalog #	Size
PRO-22-381-21	20.5 cm (8")

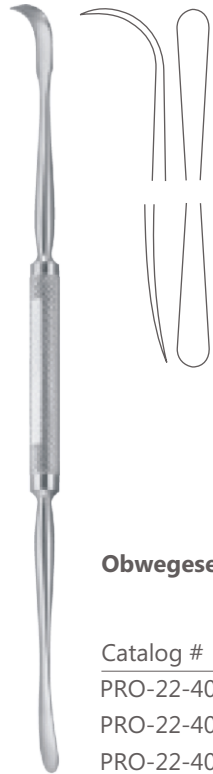

Obwegeser J-Stripper

Catalog #	Size, Blade Width
PRO-22-401-05	20.5 cm (8"), 5 mm
PRO-22-401-07	20.5 cm (8"), 7 mm
PRO-22-401-09	20.5 cm (8"), 9 mm

Obwegeser Elevator

Fig. 2

Catalog #	Size
PRO-22-383-21	20.5 cm (8")



Obwegeser Ramus Stripper

Catalog #	Size, Profile
PRO-22-405-01	17.5 cm (7"), Fig. 1
PRO-22-405-02	17.5 cm (7"), Fig. 2

Terry Ramus Pusher

Catalog #	Size
PRO-22-415-24	24 cm (9 1/2")





Steinhauser Reposition Instrument

Catalog #	Size
PRO-22-421-18	18 cm (7")

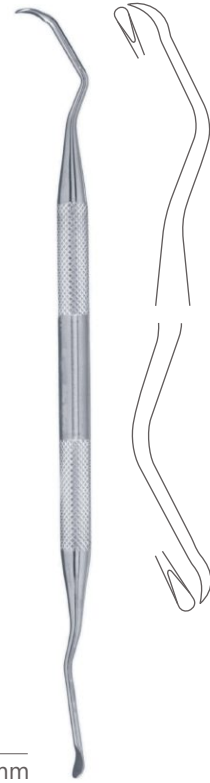

Tatum Sinus Lift Curette
Fig. 1

Catalog #	Size, Blade Width
PRO-22-451-01	18 cm (7"), 2.6 mm - 2.6 mm

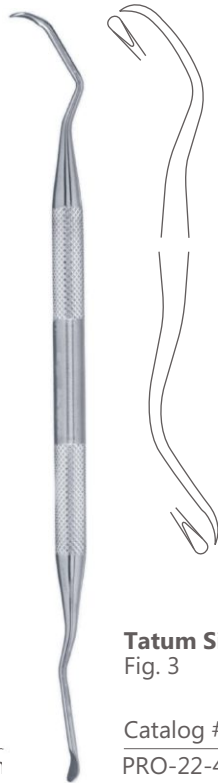

Tatum Sinus Lift Curette
Fig. 2

Catalog #	Size, Blade Width
PRO-22-453-02	17.5 cm (7"), 2.6 mm - 2.6 mm

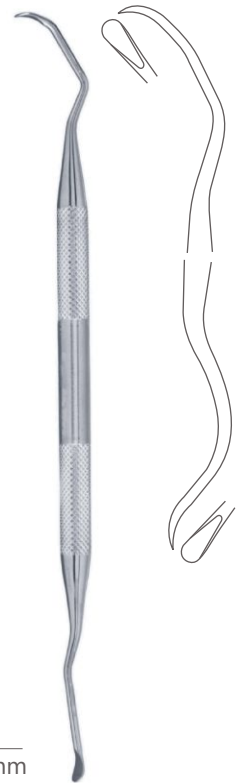

Tatum Sinus Lift Curette
Fig. 3

Catalog #	Size, Blade Width
PRO-22-455-03	18 cm (7"), 4.1 mm - 4.1 mm

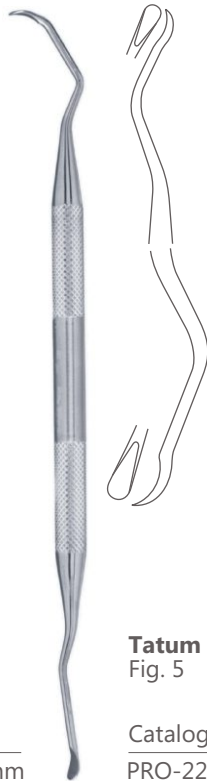

Tatum Sinus Lift Curette
Fig. 4

Catalog #	Size, Blade Width
PRO-22-457-04	18.5 cm (7 ¼"), 4.1 mm - 4.1 mm

Tatum Sinus Lift Curette
Fig. 5

Catalog #	Size, Blade Width
PRO-22-459-05	18.5 cm (7 ¼"), 6.7 mm - 6.7 mm

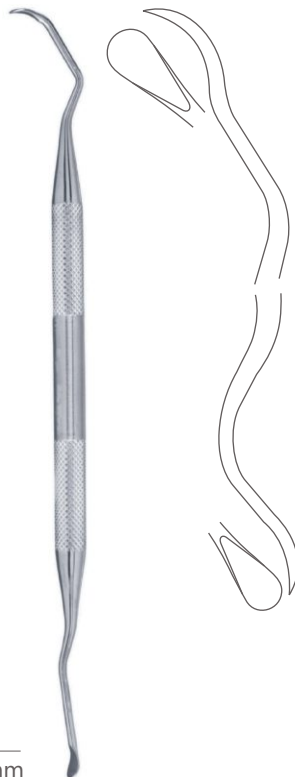

Tatum Sinus Lift Curette
Fig. 6

Catalog #	Size, Blade Width
PRO-22-461-06	19 cm (7 ½"), 6.7 mm - 6.7 mm

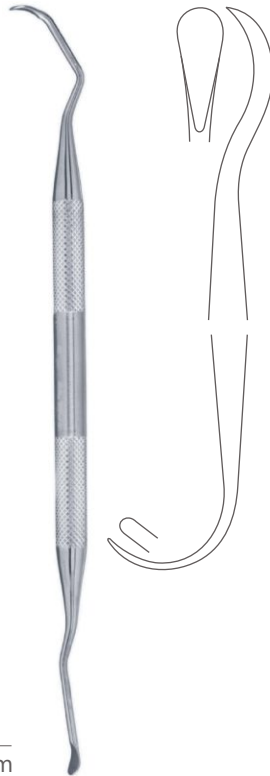

Tatum Sinus Lift Curette
Fig. 7

Catalog #	Size, Blade Width
PRO-22-463-07	16 cm (6 ¼"), 2.8 mm - 6.2 mm

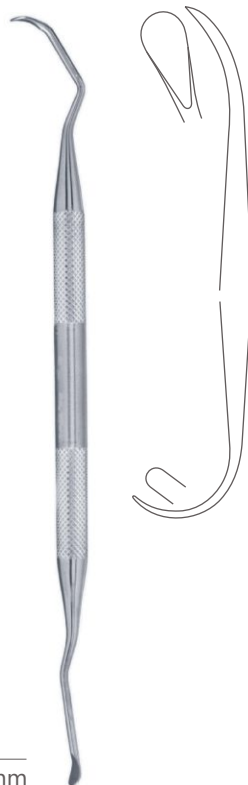

Tatum Sinus Lift Curette
Fig. 8

Catalog #	Size, Blade Width
PRO-22-465-08	16 cm (6 ¼"), 2.8 mm - 6.2 mm

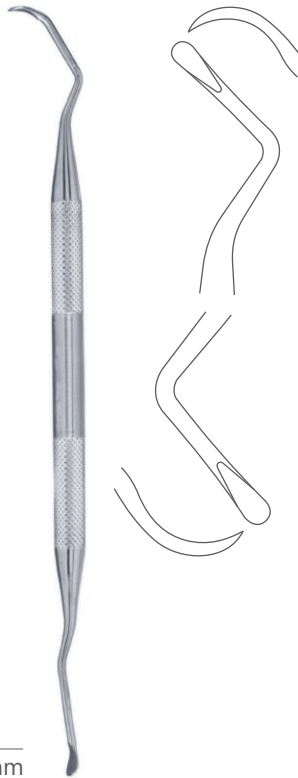

Tatum Sinus Lift Curette
Fig. 9

Catalog #	Size, Blade Width
PRO-22-467-09	15 cm (6"), 3.1 mm - 3.1 mm

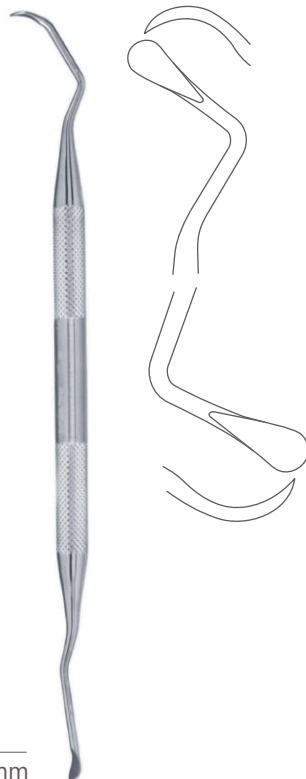

Tatum Sinus Lift Curette
Fig. 10

Catalog #	Size, Blade Width
PRO-22-469-10	17 cm (6 ¾"), 5.6 mm - 5.6 mm



Obwegeser Maxillary Awl

Catalog #	Size
PRO-22-501-15	15 cm (6")
PRO-22-501-17	17.5 cm (7")



Obwegeser Zygomatic Arch Awl

Catalog #	Size
PRO-22-503-24	24 cm (9 1/2")



Obwegeser Maxillary Awl

Catalog #	Size
PRO-22-507-18	18 cm (7")

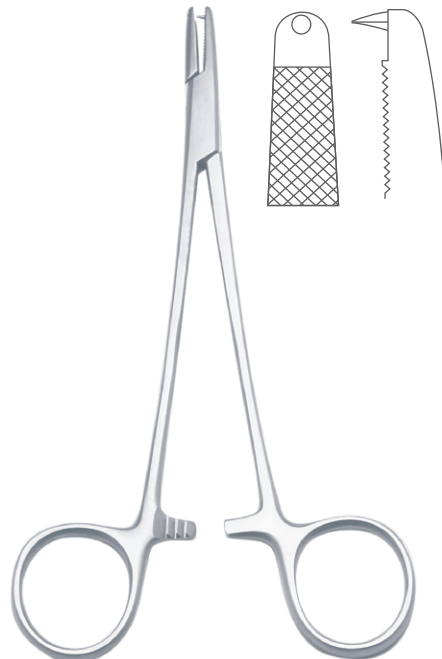

Obwegeser Wire Loop Forcep

Catalog #	Size
PRO-22-540-15	15 cm (6")



Smith Ramus Separator

Catalog #	Size
PRO-22-550-20	23.5 cm (9 1/4")

Smith Sagittal Split Separator

Catalog #	Size, Profile
PRO-22-554-01	18.5 cm (7 1/4"), Right
PRO-22-554-02	18.5 cm (7 1/4"), Left



Rowe Disimpaction Forcep

Catalog #	Size, Profile
PRO-22-570-01	22.5 cm (8 3/4"), Right
PRO-22-570-02	22.5 cm (8 3/4"), Left

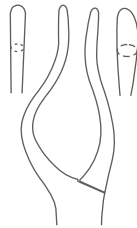



Gillies Zygoma Elevator

Catalog #	Size
PRO-22-601-21	20 cm (8")



Dingman Zygoma Elevator

Catalog #	Size, Tip Diameter
PRO-22-602-21	21 cm (8 ¼"), Ø 5.0 mm

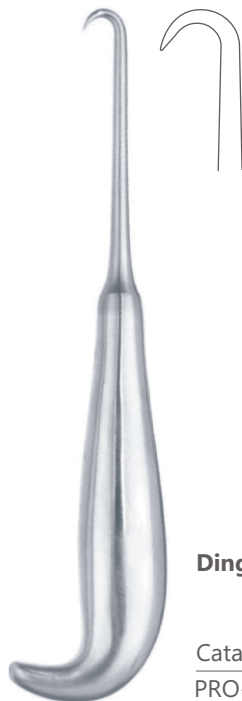

Dingman Bone Hook

Catalog #	Size, Tip Size
PRO-22-613-10	20 cm (8"), 10 mm

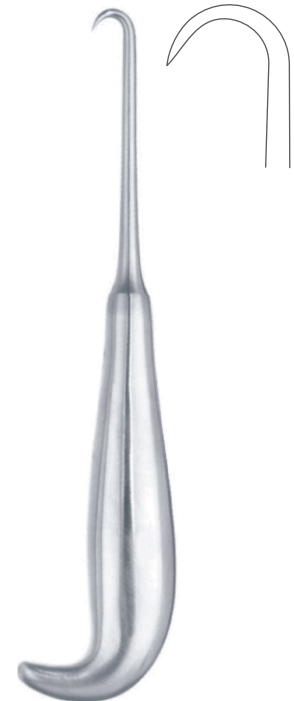

Dingman Bone Hook

Catalog #	Size, Tip Size
PRO-22-615-10	20 cm (8"), 20 mm



Turvey Palatal Expander

Catalog #	Size
PRO-22-700-17	17 cm (6 3/4")

Terry Septal Osteotome

Catalog #	Size
PRO-22-730-19	19 cm (7 1/2")

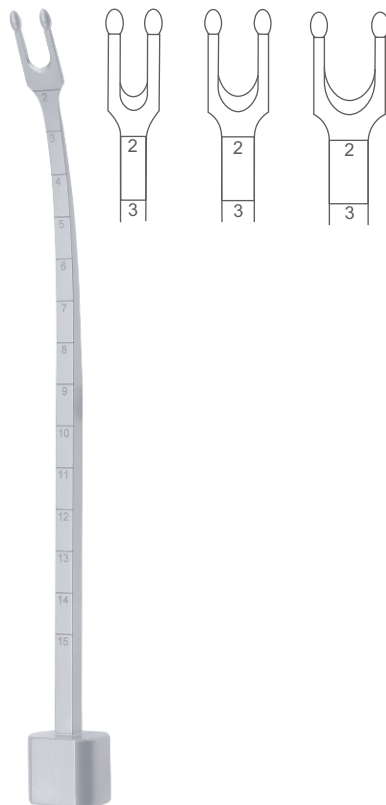

Obwegeser Septonasal Osteotome
Graduated

Catalog #	Size, Blade Width
PRO-22-735-04	18.5 cm (7 1/4"), 4 mm
PRO-22-735-06	18.5 cm (7 1/4"), 6 mm
PRO-22-735-08	18.5 cm (7 1/4"), 8 mm



FibreGrip™ Obwegeser Wedge Osteotome

Catalog #	Size, Blade Width
PRO-22-740-08	22 cm (8 ¾"), 8 mm
PRO-22-740-12	22 cm (8 ¾"), 12 mm
PRO-22-747-16	22 cm (8 ¾"), 16 mm

FibreGrip™ Obwegeser Split Osteotome

Catalog #	Size, Blade Width
PRO-22-742-08	22 cm (8 ¾"), 8 mm
PRO-22-742-12	22 cm (8 ¾"), 12 mm
PRO-22-742-16	22 cm (8 ¾"), 16 mm
PRO-22-742-20	22 cm (8 ¾"), 20 mm

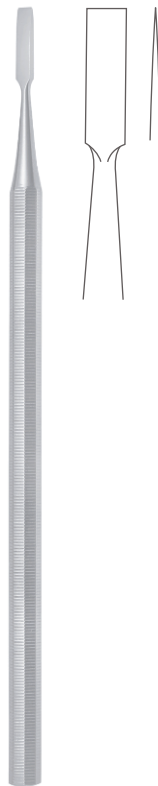

Obwegeser Osteotome
For Alveolar Process

Catalog #	Size, Blade Width
PRO-22-750-03	15 cm (6"), 3 mm
PRO-22-750-04	15 cm (6"), 4 mm
PRO-22-750-06	15 cm (6"), 6 mm



PRECISION[™]
SURGICAL WORKS

OTOLOGY INSTRUMENTS

Otologie
Otologia
Otologie
Otologia



Hartmann Ear Specula
Set of 3

Catalog #	Size
PRO-23-010-01	Standard



Hartmann Ear Specula
Set of 3

Catalog #	Size
PRO-23-010-02	Standard



Hartmann Ear Specula
Set of 3

Catalog #	Size
PRO-23-010-03	Standard



Hartmann Ear Specula
Set of 3

Catalog #	Size
PRO-23-010-03	Standard



Hartmann Ear Speculum

Catalog #	Size, Diameter, Profile
PRO-23-012-00	3.6 cm (1 1/2"), Ø 3.0 mm, Fig. 0
PRO-23-012-01	3.6 cm (1 1/2"), Ø 4.0 mm, Fig. 1
PRO-23-012-02	3.6 cm (1 1/2"), Ø 5.0 mm, Fig. 2
PRO-23-012-03	3.6 cm (1 1/2"), Ø 6.0 mm, Fig. 3
PRO-23-012-04	3.6 cm (1 1/2"), Ø 7.0 mm, Fig. 4

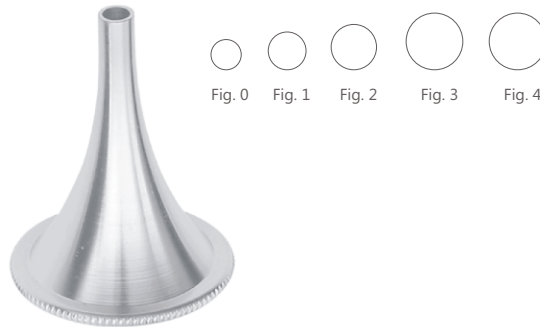

Toynbee Ear Specula

Set of 3

Catalog #	Size
PRO-23-020-01	Standard



Toynbee Ear Speculum

For Adults

Catalog #	Size
PRO-23-022-01	3.6 cm (1 1/2"), Ø 4.0 mm, Fig. 1
PRO-23-022-02	3.6 cm (1 1/2"), Ø 5.0 mm, Fig. 2
PRO-23-022-03	3.6 cm (1 1/2"), Ø 6.0 mm, Fig. 3
PRO-23-022-04	3.6 cm (1 1/2"), Ø 7.0 mm, Fig. 4

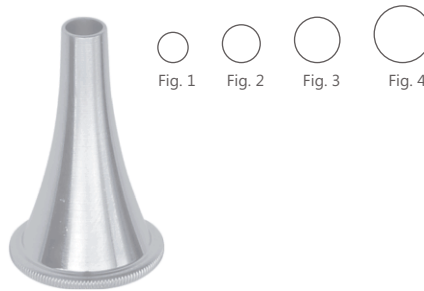

Hartmann Ear Specula (Black)
Set of 3



Catalog #	Size
PRO-23-030-01	Standard

Hartmann Ear Speculum
Black

Catalog #	Size, Profile
PRO-23-032-00	3.6 cm (1 1/2"), Fig. 0
PRO-23-032-01	3.6 cm (1 1/2"), Fig. 1
PRO-23-032-02	3.6 cm (1 1/2"), Fig. 2
PRO-23-032-03	3.6 cm (1 1/2"), Fig. 3
PRO-23-032-04	3.6 cm (1 1/2"), Fig. 4



Zeollner Ear Specula
Set of 6

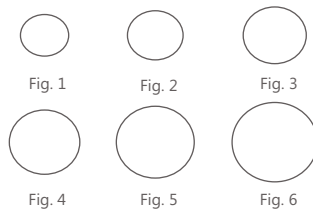

Catalog #	Size
PRO-23-040-01	Standard

Zeollner Ear Speculum
Oval, Black

Catalog #	Size, Tip Size, Profile
PRO-23-042-01	3.8 cm (1 1/2"), 5.5 x 6.5 mm. Fig. 1
PRO-23-042-02	3.8 cm (1 1/2"), 6.5 x 7.5 mm. Fig. 2
PRO-23-042-03	3.8 cm (1 1/2"), 7.5 x 8.5 mm. Fig. 3
PRO-23-042-04	3.8 cm (1 1/2"), 8.5 x 9.5 mm. Fig. 4
PRO-23-042-05	3.8 cm (1 1/2"), 9.5 x 10.5 mm. Fig. 5
PRO-23-042-06	3.8 cm (1 1/2"), 10.5 x 11.5 mm. Fig. 6

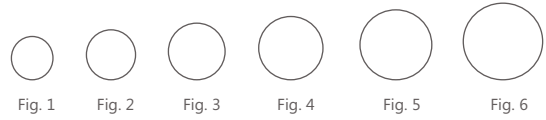

Farrior Ear Speculum
Black

Catalog #	Size, Diameter, Profile
PRO-23-052-01	3.6 cm (1 1/2"), Ø 5.5 mm, Fig. 1
PRO-23-052-02	3.6 cm (1 1/2"), Ø 6.5 mm, Fig. 2
PRO-23-052-03	3.6 cm (1 1/2"), Ø 7.5 mm, Fig. 3
PRO-23-052-04	3.6 cm (1 1/2"), Ø 8.5 mm, Fig. 4
PRO-23-052-04	3.6 cm (1 1/2"), Ø 9.5 mm, Fig. 5
PRO-23-052-06	3.6 cm (1 1/2"), Ø 10.5 mm, Fig. 6
PRO-23-052-07	3.6 cm (1 1/2"), Ø 11.5 mm, Fig. 7

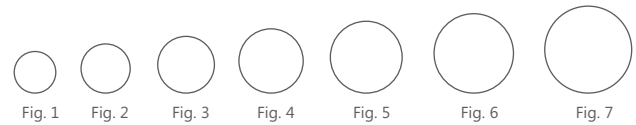

Storage Rack for Ear Specula
For 12 Specula

Catalog #	Size
PRO-23-060-12	Standard



Storage Rack for Ear Specula
For 12 Specula

Catalog #	Diameter
PRO-23-064-02	Ø 2.0 mm
PRO-23-064-04	Ø 3.0 mm
PRO-23-064-06	Ø 4.0 mm

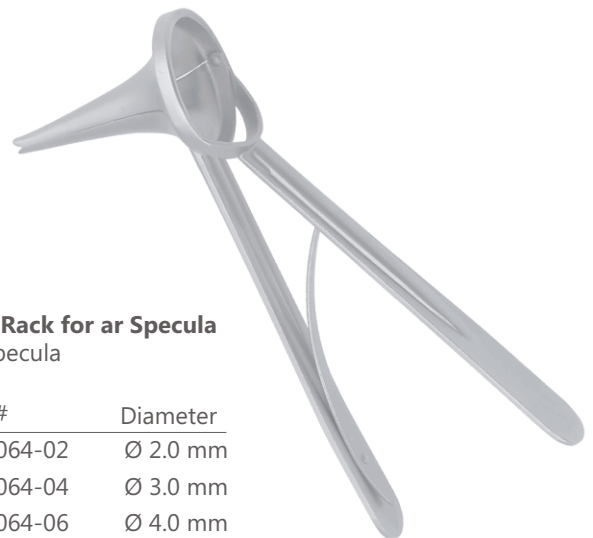

Siegle Otoscope Complete
With 3 Specula



Catalog #	Size
PRO-23-070-00	Standard

Siegle Ear Speculum



Catalog #	Diameter, Profile
PRO-23-072-01	Ø 6.5 mm, Fig. 1
PRO-23-072-02	Ø 7.0 mm, Fig. 2
PRO-23-072-03	Ø 8.0 mm, Fig. 3

Hartmann Tuning Forks
Set of 5



Catalog #	Size
PRO-23-100-10	Standard

Hartmann Tuning Forks
Set of 6



Catalog #	Size
PRO-23-100-20	Standard

Hartmann Tuning Forks
Set of 6



Catalog #	Size
PRO-23-100-30	Standard

Hartmann Tuning Fork

Catalog #	Frequency
PRO-23-102-01	C 128
PRO-23-102-02	C ¹ 256
PRO-23-102-03	C ¹ 512
PRO-23-102-04	C ² 1024
PRO-23-102-05	C ³ 2048
PRO-23-102-06	C ⁴ 4096



Hartmann Tuning Fork (French)

Catalog #	Frequency
PRO-23-104-01	C ² 16
PRO-23-104-02	C ¹ 32
PRO-23-104-03	C 64
PRO-23-104-04	C 128
PRO-23-104-05	C ¹ 256





Tuning Forks
Set of 5

Catalog #	Size
PRO-23-110-00	Standard

Tuning Fork

Catalog #	Frequency
PRO-23-112-02	C 128
PRO-23-112-03	C ¹ 256
PRO-23-112-04	C ² 512
PRO-23-112-05	C ³ 1024
PRO-23-112-06	C ⁴ 2048



Lucae Tuning Fork

Catalog #	Frequency
PRO-23-122-01	C 128
PRO-23-122-02	C ¹ 256
PRO-23-122-03	C ² 512
PRO-23-122-04	C ³ 1024
PRO-23-122-05	C ⁴ 2048
PRO-23-122-06	C ⁵ 4096



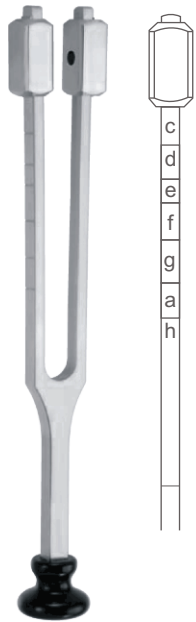

Lucae Tuning Fork
Moveable Up to h

Catalog #	Frequency
PRO-23-126-00	C 128

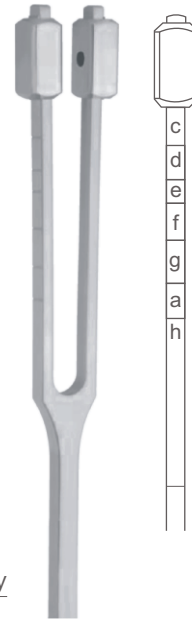

Hartmann Tuning Fork
Moveable up to h

Catalog #	Frequency
PRO-23-128-00	C 128



Hartmann Tuning Fork

Catalog #	Frequency
PRO-23-130-00	C ¹ 256

Rydel-Selffert Tuning Fork
Also for Neurology

Catalog #	Frequency With Dampers, Frequency Without Dampers
PRO-23-134-00	C 64 , C 128





Neuro Tuning Fork
With Hammer, Pinwheel, Brush and Needle

Catalog #	Frequency
PRO-23-136-00	Standard

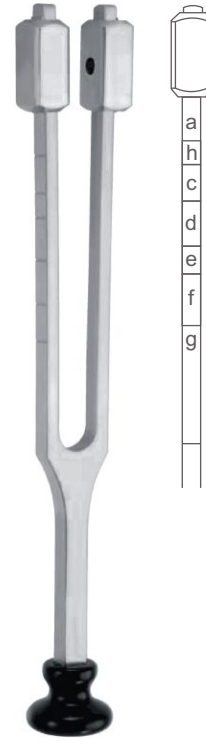

Koenig Tuning Fork
Moveable Up to g

Catalog #	Frequency
PRO-23-138-00	A 109



Tuning Fork

Catalog #	Frequency
PRO-23-140-00	a ¹ 440



Hartmann Ear Catheter

Catalog #	Size, Profile
PRO-23-150-01	15 cm (6"), Fig. 1
PRO-23-150-02	15 cm (6"), Fig. 2
PRO-23-150-03	15 cm (6"), Fig. 3



Krausa Polypus Snare
Open Tip

Catalog #	Size
PRO-23-161-18	18.5 cm (7 1/4")



Krausa-Voss Polypus Snare
Close Tip

Catalog #	Size
PRO-23-163-18	18.5 cm (7 1/4")



Lange-Wilde Polypus Snare

Catalog #	Size
PRO-23-165-16	16 cm (6 ¼")

Snare Wire

Catalog #	Size, Diameter
PRO-23-170-30	100 cm (39 ½"), Ø 0.3 mm
PRO-23-170-40	100 cm (39 ½"), Ø 0.4 mm

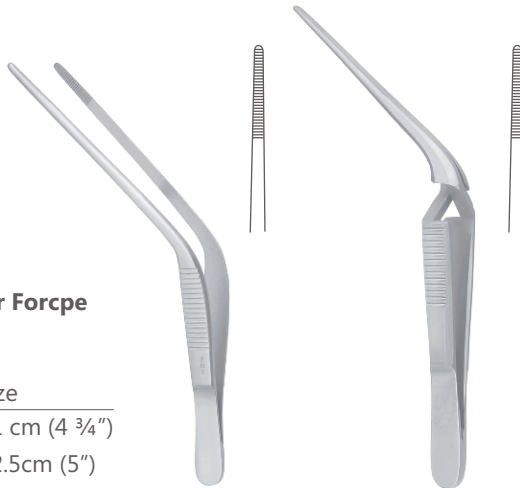

Troeltsch (Wilde) Ear Forceps

Catalog #	Size
PRO-23-201-11	11 cm (4 ¾")
PRO-23-201-13	12.5cm (5")



Troeltsch (Wilde) Ear Forceps

Catalog #	Size
PRO-23-203-11	11 cm (4 3/4")



Troeltsch (Wilde) Ear Forceps
1 x 2 Teeth

Catalog #	Size
PRO-23-205-11	11 cm (4 3/4")



Adson Ear Forceps
Bayonet Shaped

Catalog #	Size
PRO-23-207-18	17.5 cm (7")



Gruenwald (Lucae) Ear Forceps
Bayonet Shaped

Catalog #	Size
PRO-23-211-14	14.5 cm (5 3/4")



Jansen Ear Forcep
Bayonet Shaped

Catalog #	Size
PRO-23-213-16	16 cm (6 ¼")
PRO-23-213-21	21.5 cm (8 ½")



Gruenwald (Lucae) Ear Forcep
1 x 2 Teeth, Bayonet Shaped

Catalog #	Size
PRO-23-215-14	14.5 cm (5 ¾")

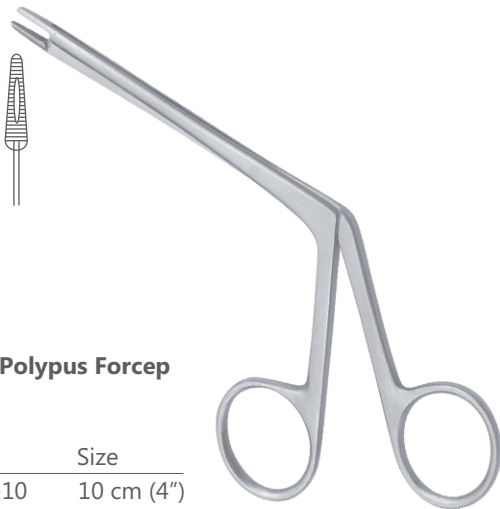

Littauer Ear Polypus Forcep

Catalog #	Size
PRO-23-221-10	10 cm (4")

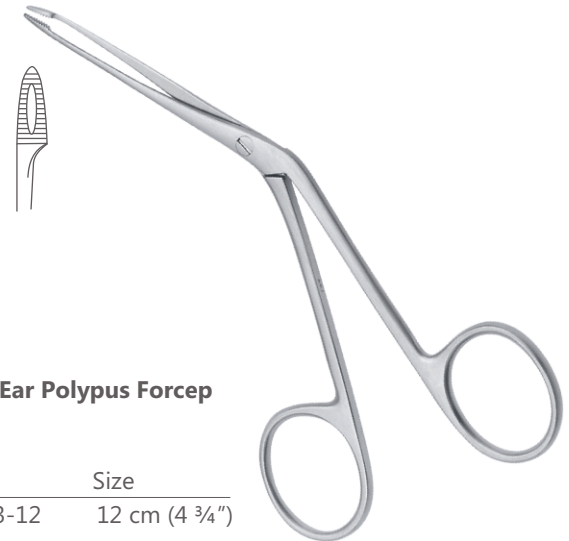

Hartmann Ear Polypus Forcep
Fine Model

Catalog #	Size
PRO-23-223-12	12 cm (4 ¾")

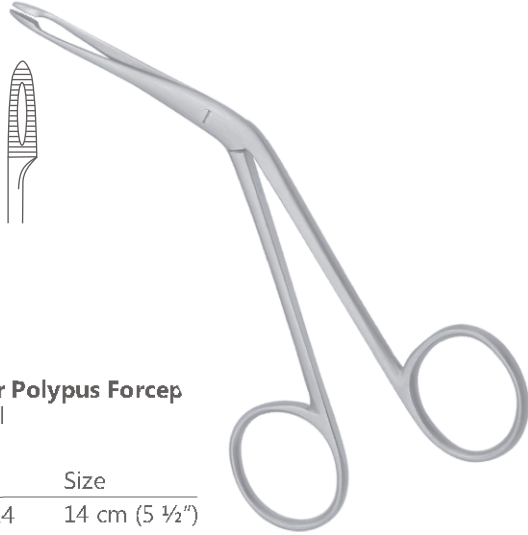

Hartmann Ear Polypus Forcep
Regular Model

Catalog #	Size
PRO-23-225-14	14 cm (5 ½")

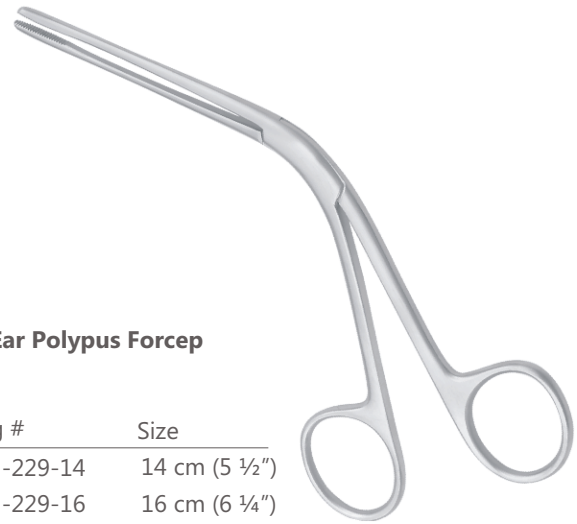

Tilley Ear Polypus Forcep

Catalog #	Size
PRO-23-229-14	14 cm (5 ½")
PRO-23-229-16	16 cm (6 ¼")



Buck Foreign Body Forcep

Catalog #	Size
PRO-23-235-11	11.5 cm (4 ½")



Quire Foreign Body Forcep

Catalog #	Size
PRO-23-237-10	10.5 cm (4")



Hartmann-Wullstein Alligator Forcep

Catalog #	Size
PRO-23-251-08	8.5 cm (3 1/4")



**Hartmann-Wullstein Alligator Forcep
Cup Shaped**

Catalog #	Size, Diameter
PRO-23-253-08	8.5 cm (3 1/4"), Ø 1.0 mm



Hartmann Alligator Forcep

Catalog #	Size
PRO-23-255-08	8.5 cm (3 1/4")
PRO-23-255-14	14 cm (5 1/2")
PRO-23-255-16	16 cm (6 1/4")

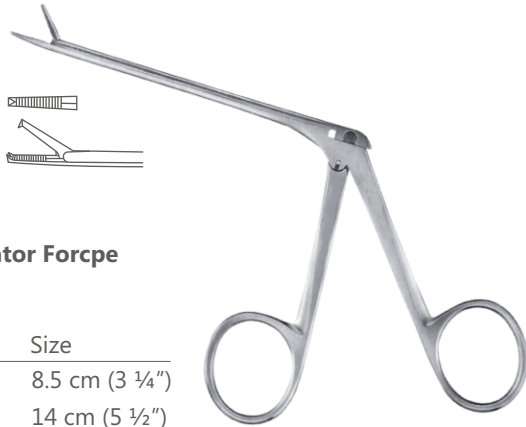

Hartmann Alligator Forcep
1 x 2 Teeth

Catalog #	Size
PRO-23-257-08	8.5 cm (3 1/4")
PRO-23-257-14	14 cm (5 1/2")



Hartmann Alligator Forcep
Cup Shaped

Catalog #	Size
PRO-23-261-20	8.5 cm (3 1/4"), Ø 2.0 mm
PRO-23-261-25	8.5 cm (3 1/4"), Ø 2.5 mm
PRO-23-261-30	8.5 cm (3 1/4"), Ø 3.0 mm



Hartmann Alligator Forcep
Bent Upwards, Cup Shaped

Catalog #	Size, Diameter
PRO-23-263-20	8.5 cm (3 1/4"), Ø 2.0 mm
PRO-23-263-30	8.5 cm (3 1/4"), Ø 3.0 mm



Struempel Alligator Forcep

Catalog #	Size
PRO-23-265-08	8.5 cm (3 1/4")



Hartmann-Weingartner Alligator Forcep

Catalog #	Size
PRO-23-267-08	8.5 cm (3 1/4")



Hartmann-Hoffmar Alligator Punch Forcep

Catalog #	Size
PRO-23-271-08	8.5 cm (3 1/4")



McGee Micro Alligator Forceps
Smooth, Straight

Catalog #	Size, Jaw Size
PRO-23-281-08	8 cm (3"), 4.0 x 0.8 mm



McGee Micro Alligator Forceps
Serrated, Straight

Catalog #	Size, Jaw Size
PRO-23-283-08	8 cm (3"), 4.0 x 0.8 mm



McGee Micro Alligator Forceps
Serrated, Bent Upwards

Catalog #	Size, Jaw Size
PRO-23-285-08	8 cm (3"), 4.0 x 0.8 mm



McGee Micro Alligator Forcep
Serrated, Right

Catalog #	Size, Jaw Size
PRO-23-287-08	8 cm (3"), 4.0 x 0.8 mm

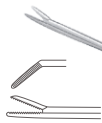

McGee Micro Alligator Forcep
Serrated, Left

Catalog #	Size, Jaw Size
PRO-23-289-08	8 cm (3"), 4.0 x 0.8 mm



Mini-McGee Micro Alligator Forcep
Smooth, Straight

Catalog #	Size, Jaw Size
PRO-23-291-08	8 cm (3"), 3.5 x 0.6 mm



Mini-McGee Micro Alligator Forcep
Serrated, Straight

Catalog #	Size, Jaw Size
PRO-23-293-08	8 cm (3"), 3.5 x 0.6 mm



Micro Alligator Forcep
Smooth, Straight

Catalog #	Size, Jaw Size
PRO-23-301-08	8 cm (3"), 4.0 x 0.6 mm



Micro Alligator Forcep
Serrated, Straight

Catalog #	Size, Jaw Size
PRO-23-303-08	8 cm (3"), 4.0 x 0.6 mm



Micro Alligator Forcep
Serrated, Bent Upwards

Catalog #	Size, Jaw Size
PRO-23-305-08	8 cm (3"), 4.0 x 0.6 mm



Micro Alligator Forcep
Serrated, Right

Catalog #	Size, Jaw Size
PRO-23-307-08	8 cm (3"), 4.0 x 0.6 mm



Micro Alligator Forcep
Serrated, Left

Catalog #	Size, Jaw Size
PRO-23-309-08	8 cm (3"), 4.0 x 0.6 mm



Micro Alligator Forcep
Straights, Cup Shaped

Catalog #	Size, Cup Size, Jaw Size
PRO-23-311-08	8 cm (3"), 1.0 x 0.9 mm, 4.0 mm



Micro Alligator Forcep
Bent Upwards, Cup Shaped

Catalog #	Size, Cup Size, Jaw Size
PRO-23-313-08	8 cm (3"), 1.0 x 0.9 mm, 4.0 mm



Micro Alligator Forcep
Right, Cup Shaped

Catalog #	Size, Cup Size, Jaw Size
PRO-23-315-08	8 cm (3"), 1.0 x 0.9 mm, 4.0 mm



Micro Alligator Forcep
Left, Cup Shaped

Catalog #	Size, Cup Size, Jaw Size
PRO-23-317-08	8 cm (3"), 1.0 x 0.9 mm, 4.0 mm



Micro Alligator Forcep
Straight, Cup Shaped

Catalog #	Size, Cup Size, Jaw Size
PRO-23-321-08	8 cm (3"), 0.6 x 0.5 mm, 3.5 mm



Micro Alligator Forcep
Bent Upwards, Cup Shaped

Catalog #	Size, Cup Size, Jaw Size
PRO-23-323-08	8 cm (3"), 0.6 x 0.5 mm, 3.5 mm



Micro Alligator Forcep
Right, Cup Shaped

Catalog #	Size, Cup Size, Jaw Size
PRO-23-325-08	8 cm (3"), 0.6 x 0.5 mm, 3.5 mm



Micro Alligator Forcep
Left, Cup Shaped

Catalog #	Size, Cup Size, Jaw Size
PRO-23-327-08	8 cm (3"), 0.6 x 0.5 mm, 3.5 mm



Bellucci Micro Scissor
Straight, Very Fine

Catalog #	Size, Blade Size
PRO-23-331-08	8 cm (3"), 4.0 x 0.8 mm



Bellucci Micro Scissor
Bent Upwards, Very Fine

Catalog #	Size, Blade Size
PRO-23-333-08	8 cm (3"), 4.0 x 0.8 mm



Bellucci Micro Scissor
Right, Very Fine

Catalog #	Size, Blade Size
PRO-23-335-08	8 cm (3"), 4.0 x 0.8 mm



Bellucci Micro Scissor
Left, Very Fine

Catalog #	Size, Blade Size
PRO-23-337-08	8 cm (3"), 4.0 x 0.8 mm



Wullstein Micro Scissor
Straight

Catalog #	Size, Blade Size
PRO-23-341-08	8 cm (3"), 4.0 x 1.8 mm



Wullstein Micro Scissor
Bent Upwards

Catalog #	Size, Blade Size
PRO-23-343-08	8 cm (3"), 4.0 x 1.8 mm

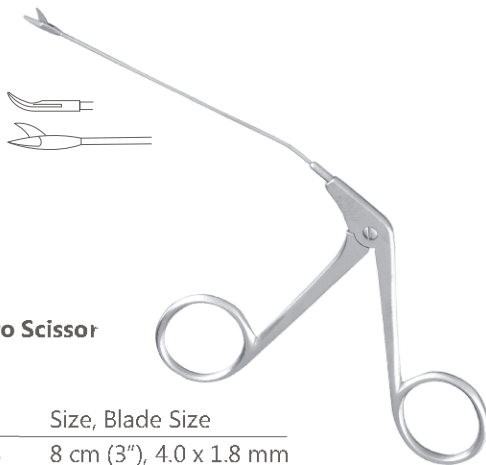

Wullstein Micro Scissor
Right

Catalog #	Size, Blade Size
PRO-23-345-08	8 cm (3"), 4.0 x 1.8 mm

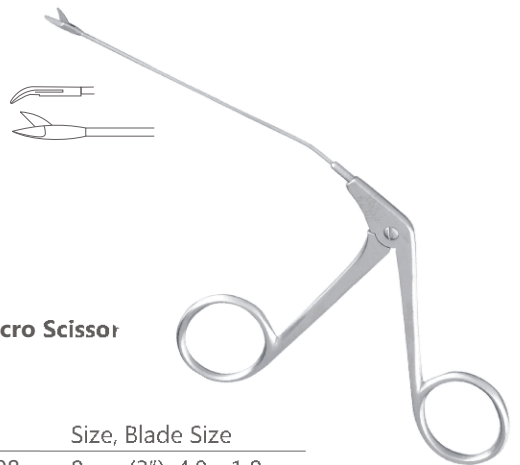

Wullstein Micro Scissor
Left

Catalog #	Size, Blade Size
PRO-23-347-08	8 cm (3"), 4.0 x 1.8 mm

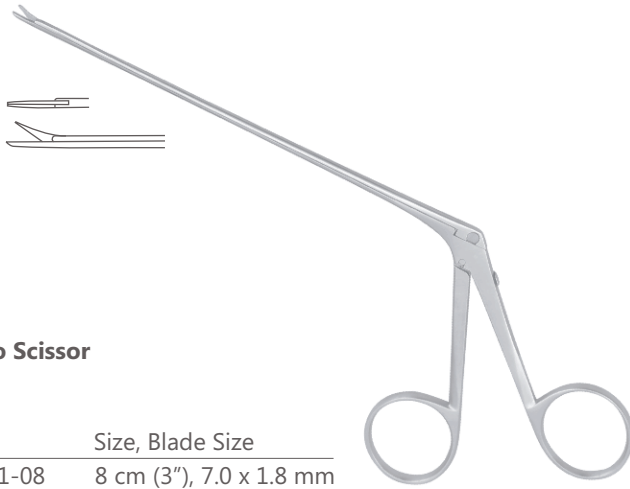

Shea Micro Scissor
Straight

Catalog #	Size, Blade Size
PRO-23-351-08	8 cm (3"), 7.0 x 1.8 mm

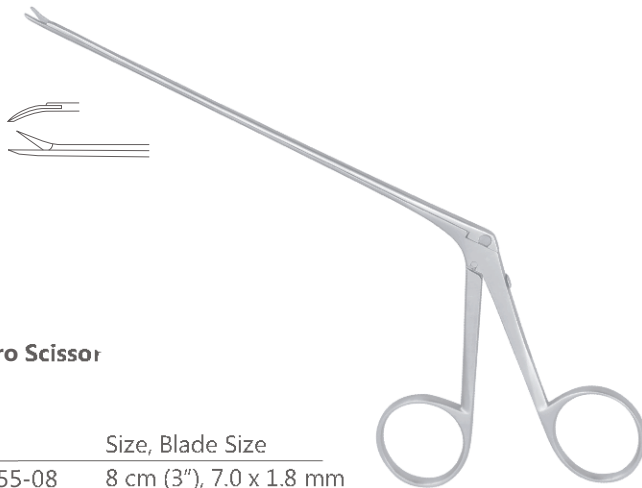

Shea Micro Scissor
Right

Catalog #	Size, Blade Size
PRO-23-355-08	8 cm (3"), 7.0 x 1.8 mm

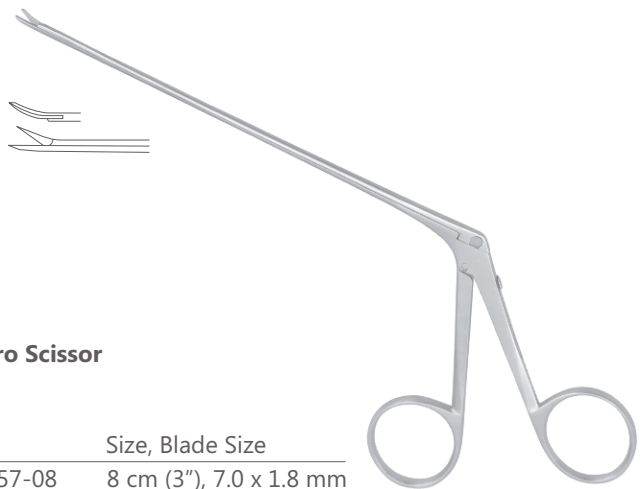

Shea Micro Scissor
Left

Catalog #	Size, Blade Size
PRO-23-357-08	8 cm (3"), 7.0 x 1.8 mm

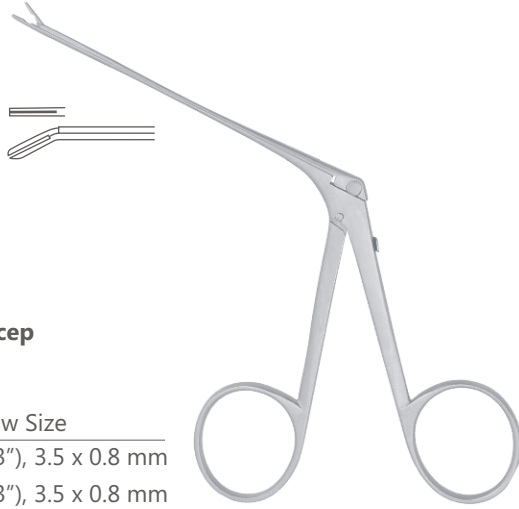

McGee Wire Bending Forcep
Bent Downwards

Catalog #	Size, Jaw Size
PRO-23-361-01	8 cm (3"), 3.5 x 0.8 mm
PRO-23-361-02	8 cm (3"), 3.5 x 0.8 mm

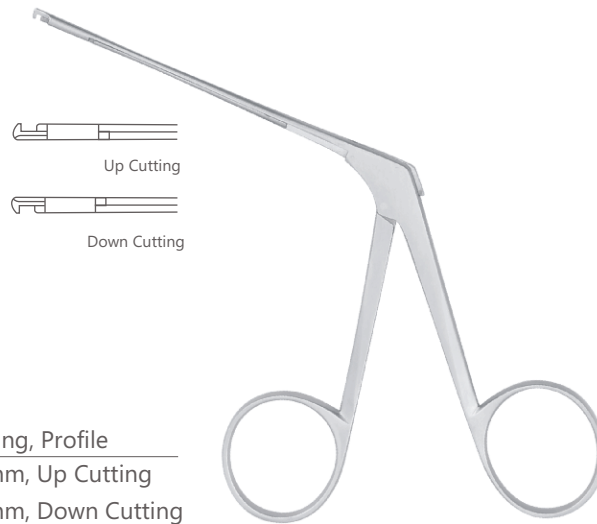

House-Dieter Malleus Nipper

Catalog #	Size, Jaw Opening, Profile
PRO-23-365-01	8 cm (3"), 1.3 mm, Up Cutting
PRO-23-365-02	8 cm (3"), 1.3 mm, Down Cutting

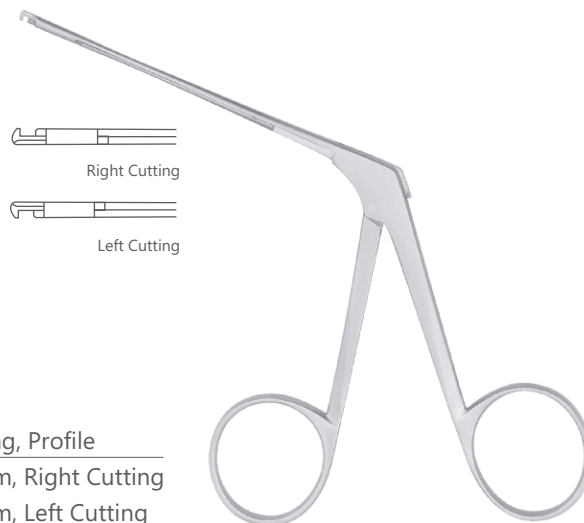

House-Dieter Malleus Nipper

Catalog #	Size, Jaw Opening, Profile
PRO-23-365-03	8 cm (3"), 1.3 mm, Right Cutting
PRO-23-365-04	8 cm (3"), 1.3 mm, Left Cutting



Fuller Introducing Frocep
For Teflon Prosthesis

Catalog #	Size
PRO-23-367-08	8 cm (3")



Schuknecht Rotary Knife

Catalog #	Size
PRO-23-401-01	15 cm (6")
PRO-23-401-02	15 cm (6")

Schuknecht Sickle Knife

Catalog #	Size
PRO-23-403-15	14.5 cm (5 ¾")

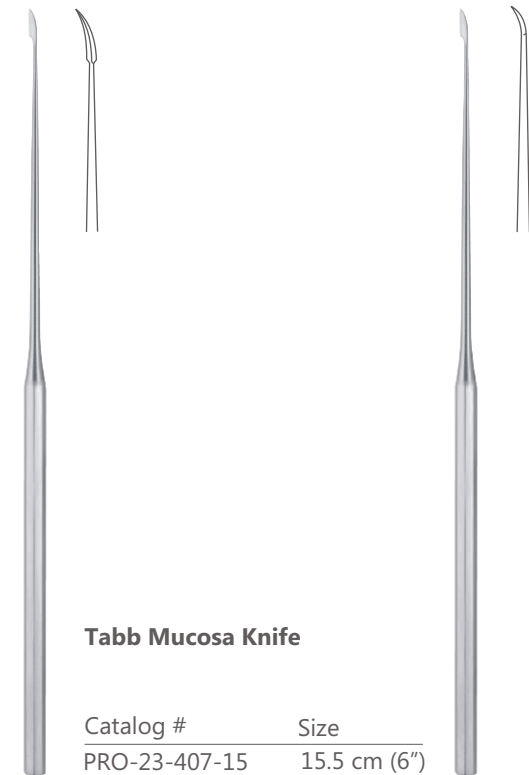

Wullstein Sickle Knife

Catalog #	Size
PRO-23-405-15	15.5 cm (6")

Tabb Mucosa Knife

Catalog #	Size
PRO-23-407-15	15.5 cm (6")



Rosen Circular Cut Knife

Catalog #	Size, Diameter, Profile
PRO-23-421-01	15 cm (6"), Ø 3.0 mm, Fig. 1
PRO-23-421-02	15 cm (6"), Ø 2.8 mm, Fig. 2
PRO-23-421-03	15 cm (6"), Ø 2.6 mm, Fig. 3
PRO-23-421-04	15 cm (6"), Ø 2.0 mm, Fig. 4
PRO-23-421-05	15 cm (6"), Ø 1.6 mm, Fig. 5
PRO-23-421-06	15 cm (6"), Ø 1.4 mm, Fig. 6
PRO-23-421-07	15 cm (6"), Ø 1.0 mm, Fig. 7

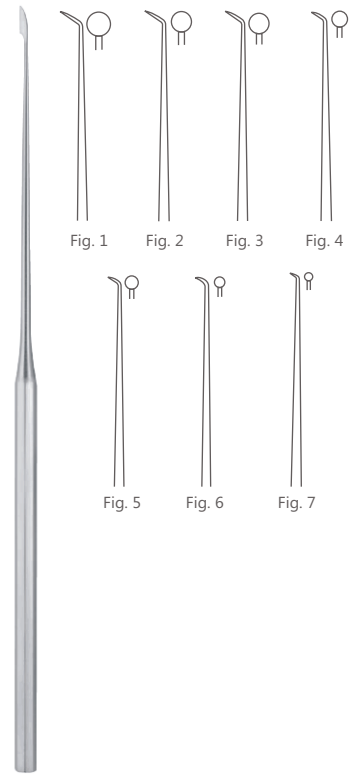

Plester Flap Knife

Catalog #	Size
PRO-23-409-15	15 cm (6")



Barbara Micro Ear Pick

Catalog #	Size
PRO-23-450-16	16 cm (6 ¼")



Barbara Micro Ear Pick Angled

Catalog #	Size
PRO-23-451-16	16 cm (6 ¼")



Rosen Micro Ear Pick

Catalog #	Size
PRO-23-453-16	16 cm (6 ¼")



Barbara Micro Ear Pick

Catalog #	Size
PRO-23-453-16	16 cm (6 ¼")



Barbara Micro Ear Pick
Angled 45°

Catalog #	Size, Tip Size
PRO-23-461-03	16 cm (6 ¼"), 0.3 mm
PRO-23-461-06	16 cm (6 ¼"), 0.6 mm
PRO-23-461-10	16 cm (6 ¼"), 1.0 mm
PRO-23-461-12	16 cm (6 ¼"), 1.2 mm
PRO-23-461-15	16 cm (6 ¼"), 1.5 mm
PRO-23-461-20	16 cm (6 ¼"), 2.0 mm
PRO-23-461-25	16 cm (6 ¼"), 2.5 mm

Barbara Micro Ear Pick
Angled 25°

Catalog #	Size, Tip Size
PRO-23-459-03	16 cm (6 ¼"), 0.3 mm
PRO-23-459-06	16 cm (6 ¼"), 0.6 mm
PRO-23-459-10	16 cm (6 ¼"), 1.0 mm



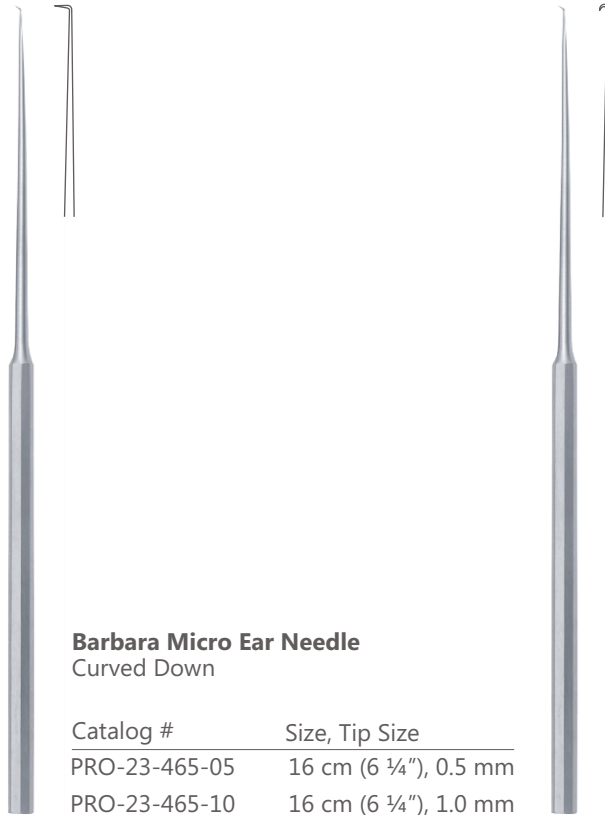

Barbara Micro Ear Pick
Angled 90°

Catalog #	Size, Tip Size
PRO-23-463-03	16 cm (6 ¼"), 0.3 mm
PRO-23-463-06	16 cm (6 ¼"), 0.6 mm
PRO-23-463-10	16 cm (6 ¼"), 1.0 mm
PRO-23-463-12	16 cm (6 ¼"), 1.2 mm
PRO-23-463-15	16 cm (6 ¼"), 1.5 mm
PRO-23-463-20	16 cm (6 ¼"), 2.0 mm
PRO-23-463-25	16 cm (6 ¼"), 2.5 mm

Barbara Micro Ear Needle
Curved Down

Catalog #	Size, Tip Size
PRO-23-465-05	16 cm (6 ¼"), 0.5 mm
PRO-23-465-10	16 cm (6 ¼"), 1.0 mm

Micro Ear Needle
Angled 90°

Catalog #	Size, Tip Size
PRO-23-467-03	15.5 cm (6"), 0.3 mm
PRO-23-467-06	15.5 cm (6"), 0.6 mm
PRO-23-467-10	15.5 cm (6"), 1.0 mm

McGee Micro Ear Needle
For Footplate

Catalog #	Size, Tip Size
PRO-23-473-05	15.5 cm (6"), 0.5 mm
PRO-23-473-10	15.5 cm (6"), 1.0 mm

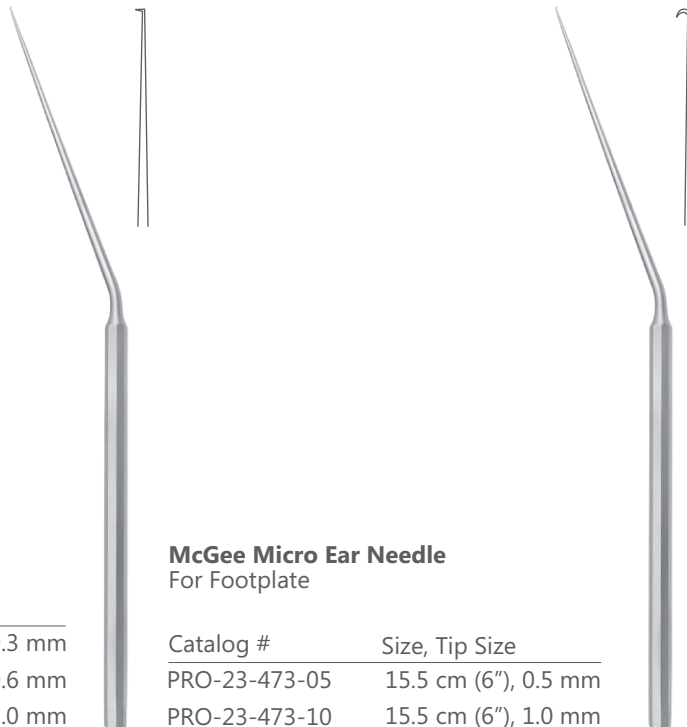



Micro Ear Pick
Angled 25°

Catalog #	Size, Tip Size
PRO-23-481-03	15.5 cm (6"), 0.3 mm
PRO-23-481-06	15.5 cm (6"), 0.6 mm
PRO-23-481-10	15.5 cm (6"), 1.0 mm



Micro Ear Pick
Angled 45°

Catalog #	Size, Tip Size
PRO-23-485-03	15.5 cm (6"), 0.3 mm
PRO-23-485-06	15.5 cm (6"), 0.6 mm
PRO-23-485-10	15.5 cm (6"), 1.0 mm



Micro Ear Needle
Angled 25°

Catalog #	Size, Tip Size
PRO-23-491-03	15.5 cm (6"), 0.3 mm
PRO-23-491-06	15.5 cm (6"), 0.6 mm



Shambaugh Micro Ear Needle
Angled 25°

Catalog #	Size, Tip Size
PRO-23-491-10	15.5 cm (6"), 1.0 mm



Micro Ear Needle
Angled 45°

Catalog #	Size, Tip Size
PRO-23-493-03	15.5 cm (6"), 0.3 mm
PRO-23-493-06	15.5 cm (6"), 0.6 mm

Shambaugh Micro Ear Needle
Angled 45°

Catalog #	Size, Tip Size
PRO-23-493-10	15.5 cm (6"), 1.0 mm

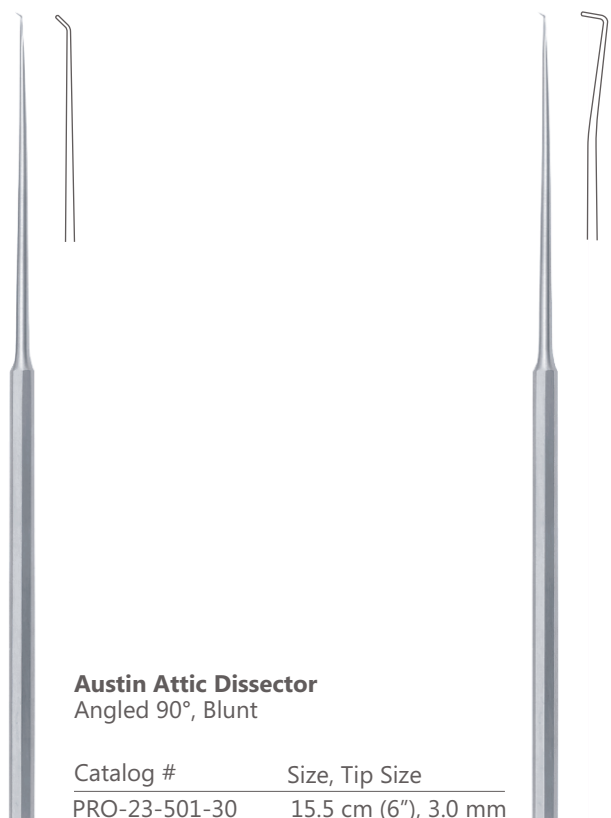

Shea Exploring Hook
Angled 45°, Blunt

Catalog #	Size, Tip Size
PRO-23-497-20	15.5 cm (6"), 2.0 mm

Austin Attic Dissector
Angled 90°, Blunt

Catalog #	Size, Tip Size
PRO-23-501-30	15.5 cm (6"), 3.0 mm



Fisch Micro Dissector

Catalog #	Size, Profile
PRO-23-505-01	15.5 cm (6"), Angled to Right
PRO-23-505-02	15.5 cm (6"), Angled to Left
PRO-23-505-03	15.5 cm (6"), Angled to Right
PRO-23-505-04	15.5 cm (6"), Angled to Left



Rosen Micro Ear Periosteal Elevator

Catalog #	Size
PRO-23-509-01	15.5 cm (6")
PRO-23-509-02	15.5 cm (6")
PRO-23-509-03	15.5 cm (6")



Rosen Micro Curette

Catalog #	Size
PRO-23-509-04	15.5 cm (6")



Rosen Micro Dissector

Catalog #	Size
PRO-23-509-05	15.5 cm (6")
PRO-23-509-06	15.5 cm (6")



House Micro Measuring Rod

Catalog #	Size, Tip Size
PRO-23-511-01	15.5 cm (6"), 3.5 mm
PRO-23-511-02	15.5 cm (6"), 4.0 mm
PRO-23-511-03	15.5 cm (6"), 4.5 mm
PRO-23-511-04	15.5 cm (6"), 5.0 mm

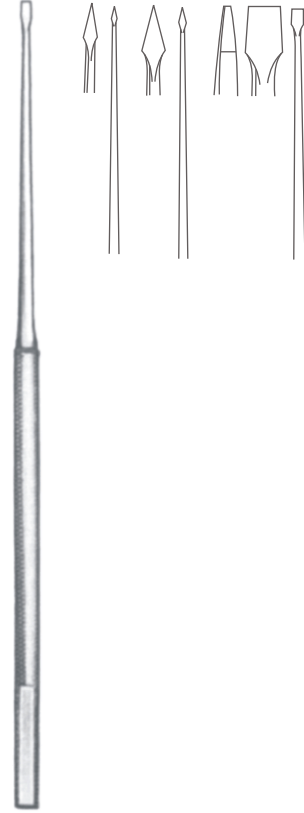

Buckingham Chisel

Catalog #	Size, Tip Size
PRO-23-515-01	18 cm (7"), 0.5 mm
PRO-23-515-02	18 cm (7"), 1.0 mm
PRO-23-515-04	18 cm (7"), 1.5 mm



Dingman Otoprader

Catalog #	Size, Profile
PRO-23-517-01	Standard, Left
PRO-23-517-02	Standard, Right

House Micro Ear Curette

Catalog #	Size, Cup Size 1, Cup Size 2
PRO-23-520-01	14.5 cm (5 3/4"), 1.0 mm, 1.2 mm
PRO-23-520-02	14.5 cm (5 3/4"), 1.5 mm, 1.8 mm
PRO-23-520-03	14.5 cm (5 3/4"), 1.0 mm, 1.2 mm
PRO-23-520-04	14.5 cm (5 3/4"), 1.5 mm, 1.8 mm





Shea Micro Ear Curette

Catalog #	Size
PRO-23-525-14	14.5 cm (5 3/4")



Zoellner Micro Ear Needle
Straight

Catalog #	Size
PRO-23-535-01	Standard

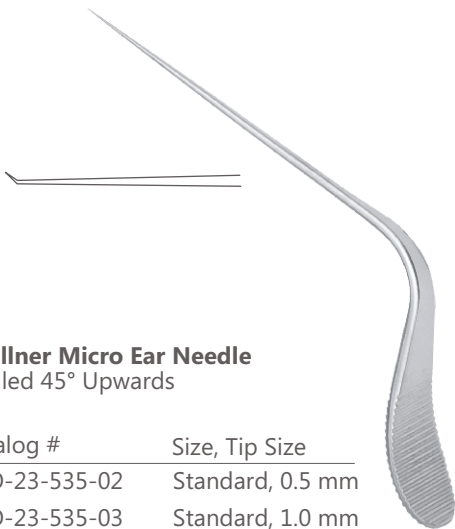

Zoellner Micro Ear Needle
Angled 45° Upwards

Catalog #	Size, Tip Size
PRO-23-535-02	Standard, 0.5 mm
PRO-23-535-03	Standard, 1.0 mm



Zoellner Micro Ear Needle
Angled 45° Downwards

Catalog #	Size, Tip Size
PRO-23-535-04	Standard, 0.5 mm
PRO-23-535-05	Standard, 1.0 mm



Zoellner Micro Ear Needle
Angled 90° Upwards

Catalog #	Size, Tip Size
PRO-23-535-06	Standard, 0.5 mm



Zoellner Micro Ear Needle
Angled 90° Downwards

Catalog #	Size, Tip Size
PRO-23-535-06	Standard, 0.5 mm



Zoellner Micro Ear Needle
For Footplate

Catalog #	Size, Tip Size
PRO-23-535-08	Standard, 1.0 mm
PRO-23-535-09	Standard, 1.0 mm



Zoellner Ear Knife
Angled 90° Upwards

Catalog #	Size
PRO-23-535-10	Standard

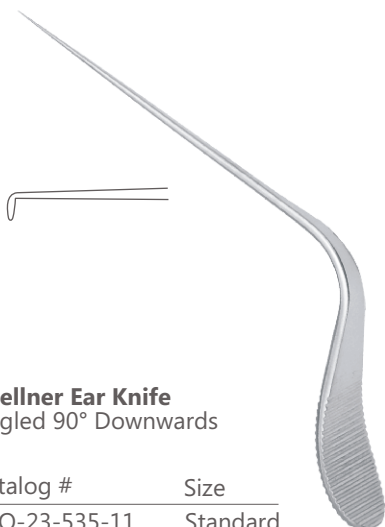

Zoellner Ear Knife
Angled 90° Downwards

Catalog #	Size
PRO-23-535-11	Standard



Zoellner Micro Ear Knife
Angled Upwards

Catalog #	Size
PRO-23-535-12	Standard



Zoellner Micro Ear Knife
Angled Downwards

Catalog #	Size
PRO-23-535-13	Standard

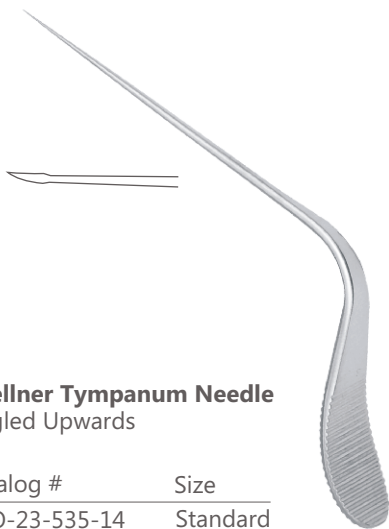

Zoellner Tympanum Needle
Angled Upwards

Catalog #	Size
PRO-23-535-14	Standard

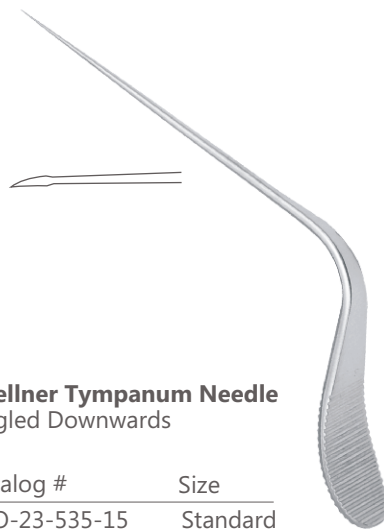

Zoellner Tympanum Needle
Angled Downwards

Catalog #	Size
PRO-23-535-15	Standard

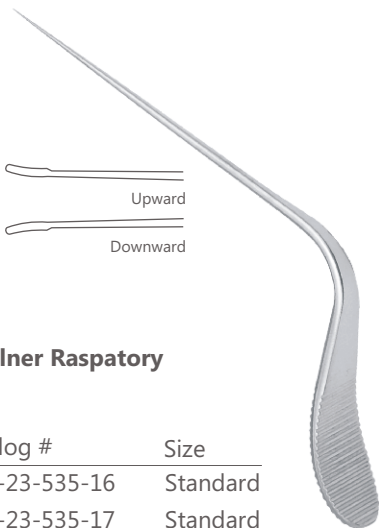

Zoellner Raspatory

Catalog #	Size
PRO-23-535-16	Standard
PRO-23-535-17	Standard

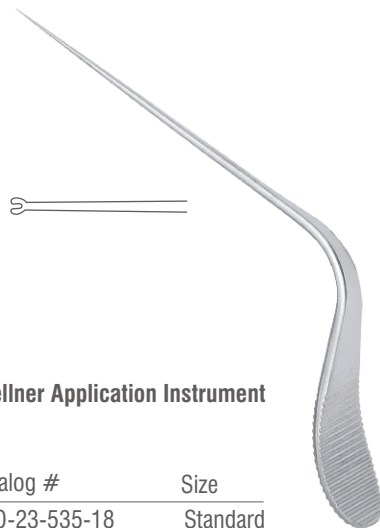

Zoellner Application Instrument

Catalog #	Size
PRO-23-535-18	Standard



Langenbeck Ear Curette
Blunt

Catalog #	Size
PRO-23-551-13	13 cm (5")

Shapleigh Ear Curette

Catalog #	Size, Profile
PRO-23-555-01	15 cm (6"), Fig. 1
PRO-23-555-02	15 cm (6"), Fig. 2



Buck Ear Curette
Straight, Blunt

Catalog #	Size, Profile
PRO-23-570-01	17 cm (6 3/4"), Fig. 000
PRO-23-570-02	17 cm (6 3/4"), Fig. 00
PRO-23-570-10	17 cm (6 3/4"), Fig. 0
PRO-23-570-11	17 cm (6 3/4"), Fig. 1
PRO-23-570-12	17 cm (6 3/4"), Fig. 2
PRO-23-570-13	17 cm (6 3/4"), Fig. 3
PRO-23-570-14	17 cm (6 3/4"), Fig. 4

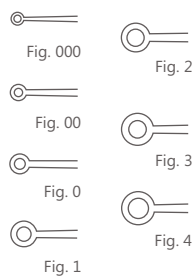

Buck Ear Curette
Angled, Blunt

Catalog #	Size, Profile
PRO-23-571-01	17 cm (6 3/4"), Fig. 000
PRO-23-571-02	17 cm (6 3/4"), Fig. 00
PRO-23-571-10	17 cm (6 3/4"), Fig. 0
PRO-23-571-11	17 cm (6 3/4"), Fig. 1
PRO-23-571-12	17 cm (6 3/4"), Fig. 2
PRO-23-571-13	17 cm (6 3/4"), Fig. 3
PRO-23-571-14	17 cm (6 3/4"), Fig. 4

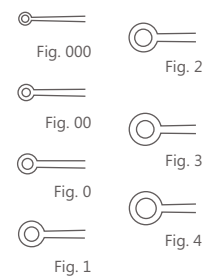

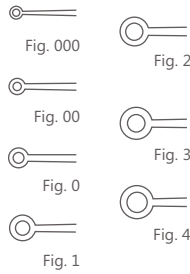

Buck Ear Curette
Straight, Sharp

Catalog #	Size, Profile
PRO-23-572-01	17 cm (6 3/4"), Fig. 000
PRO-23-572-02	17 cm (6 3/4"), Fig. 00
PRO-23-572-10	17 cm (6 3/4"), Fig. 0
PRO-23-572-11	17 cm (6 3/4"), Fig. 1
PRO-23-572-12	17 cm (6 3/4"), Fig. 2
PRO-23-572-13	17 cm (6 3/4"), Fig. 3
PRO-23-572-14	17 cm (6 3/4"), Fig. 4

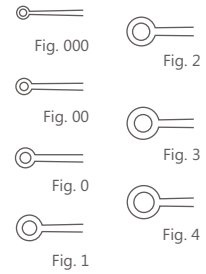

Buck Ear Curette
Angled, Sharp

Catalog #	Size, Profile
PRO-23-573-01	17 cm (6 3/4"), Fig. 000
PRO-23-573-02	17 cm (6 3/4"), Fig. 00
PRO-23-573-10	17 cm (6 3/4"), Fig. 0
PRO-23-573-11	17 cm (6 3/4"), Fig. 1
PRO-23-573-12	17 cm (6 3/4"), Fig. 2
PRO-23-573-13	17 cm (6 3/4"), Fig. 3
PRO-23-573s-14	17 cm (6 3/4"), Fig. 4

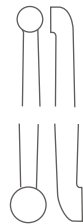

Jansen Ear Scoop
Sharp

Catalog #	Size
PRO-23-576-15	17 cm (6 3/4")



Barth Ear Scoop
Sharp

Catalog #	Size
PRO-23-580-18	18 cm (7")



Lempert Ear Scoop
Sharp

Catalog #	Size, Profile
PRO-23-600-10	21.5 cm (8 ½"), Fig. 0
PRO-23-600-20	21.5 cm (8 ½"), Fig. 00
PRO-23-600-30	21.5 cm (8 ½"), Fig. 000
PRO-23-600-40	21.5 cm (8 ½"), Fig. 0000
PRO-23-600-50	21.5 cm (8 ½"), Fig. 00000



Gross Ear Scoop-Hook
Blunt

Catalog #	Size
PRO-23-583-13	13 cm (5")



FiberGrip™ Lempert Ear Scoop
Sharp

Catalog #	Size, Profile
PRO-23-610-10	21.5 cm (8 ½"), Fig. 0
PRO-23-610-20	21.5 cm (8 ½"), Fig. 00
PRO-23-610-30	21.5 cm (8 ½"), Fig. 000
PRO-23-610-40	21.5 cm (8 ½"), Fig. 0000
PRO-23-610-50	21.5 cm (8 ½"), Fig. 00000



Billeau Ear Loop

Catalog #	Size
PRO-23-660-01	16 cm (6 ¼")
PRO-23-660-02	16 cm (6 ¼")
PRO-23-660-03	16 cm (6 ¼")



Weber-Loch Ear Loop

Catalog #	Size
PRO-23-650-01	16.5 cm (6 ¼")



Lucae Ear Hook

Catalog #	Size, Profile
PRO-23-673-01	14 cm (5 ½"), Small
PRO-23-673-02	14 cm (5 ½"), Medium
PRO-23-673-03	14 cm (5 ½"), Large

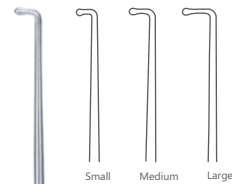

Hartmann Ear Hook
Sharp

Catalog #	Size
PRO-23-671-16	16 cm (6 ¼")





Wagener Ear Hook

Catalog #	Size, Point Size, Profile
PRO-23-675-01	14 cm (5 1/2"), 2 mm, Fig. 1
PRO-23-675-02	14 cm (5 1/2"), 2.5 mm, Fig. 2
PRO-23-675-03	14 cm (5 1/2"), 3 mm, Fig. 3
PRO-23-675-04	14 cm (5 1/2"), 3.5 mm, Fig. 4
PRO-23-675-05	14 cm (5 1/2"), 4 mm, Fig. 5

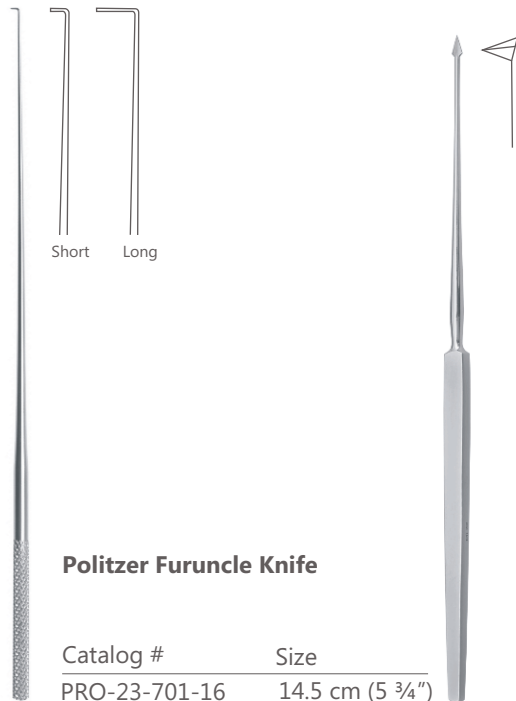

Day Ear Hook

Catalog #	Size, Profile
PRO-23-677-01	17 cm (6 3/4"), Long
PRO-23-677-02	17 cm (6 3/4"), Short

Politzer Furuncle Knife

Catalog #	Size
PRO-23-701-16	14.5 cm (5 3/4")



Politzer Tympanum Needle

Catalog #	Size
PRO-23-704-16	17.5 cm (7")



Catalog #	Size
PRO-23-707-16	15.5 cm (6")



Politzer Tympanum Needle
Needle Horizontal

Catalog #	Size
PRO-23-709-16	16 cm (6 1/4")



Lucae Tympanum Needle

Catalog #	Size
PRO-23-711-16	17.5 cm (7")



Lucae Tympanum Needle

Catalog #	Size
PRO-23-713-16	17.5 cm (7")



Moldnehauser Foreign Body Lever

Catalog #	Size
PRO-23-721-16	15.5 cm (6")



Zaufal Foreign Body Lever

Catalog #	Size
PRO-23-723-16	15 cm (6")



Lempert Periosteal Elevator

Catalog #	Size, Width
PRO-23-727-20	20.5 cm (8"), 6 mm



Lempert Periosteal Elevator

Lempert Periosteal Elevator

Catalog #	Size, Width
PRO-23-729-18	18 cm (7"), 6 mm

Catalog #	Size, Width
PRO-23-731-02	17 cm (6 ¾"), 2 mm
PRO-23-731-03	17 cm (6 ¾"), 3 mm
PRO-23-731-04	17 cm (6 ¾"), 4 mm
PRO-23-731-05	17 cm (6 ¾"), 5 mm

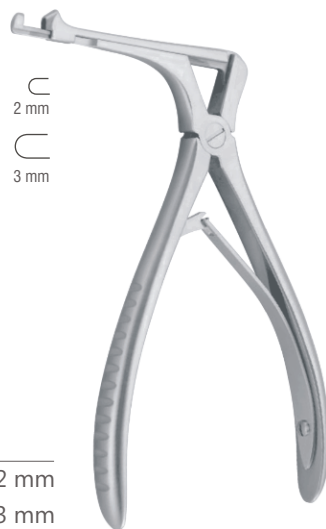

Citelli Mastoid Rongeur

Catalog #	Size, Bite Size
PRO-23-751-02	17 cm (6 ¾"), 2 mm
PRO-23-751-03	17 cm (6 ¾"), 3 mm

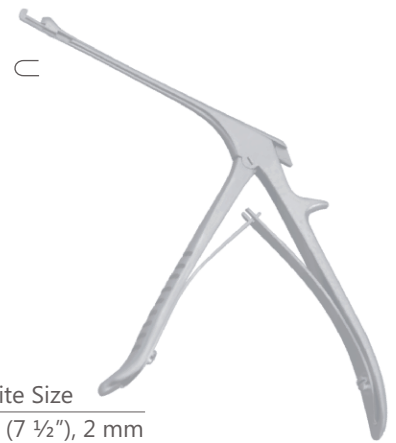

Beyer Mastoid Rongeur

Catalog #	Size, Bite Size
PRO-23-755-19	19 cm (7 ½"), 2 mm



Beyer Mastoid Rongeur

Catalog #	Size, Bite Size
PRO-23-759-14	14 cm (5 1/2"), 1 mm



Ear Syringe Complete
With Protection Disk and 2 Tips

Catalog #	Capacity
PRO-23-800-00	50 ml
PRO-23-802-00	100 ml



PRECISION[™]
SURGICAL WORKS

RHINOLOGY INSTRUMENTS

Rhinologie
Rinología
Rhinologie
Rinologia





Thudichum Nasal Specula

Set of 3

Catalog #	Size
PRO-25-011-10	Standard

Thudichum Nasal Specula

Set of 4

Catalog #	Size
PRO-25-011-20	Standard

Thudichum Nasal Speculum



Catalog #	Blade Size, Profile
PRO-25-013-01	12 mm , Fig. 1
PRO-25-013-02	14 mm , Fig. 2
PRO-25-013-03	16.5 mm , Fig. 3
PRO-25-013-04	18.5 mm , Fig. 4
PRO-25-013-05	20.5 mm, Fig. 5
PRO-25-013-06	22 mm, Fig. 6
PRO-25-013-07	23 mm, Fig. 7

Voltolini Nasal Speculum



Catalog #	Size, Profile
PRO-25-017-01	Standard, Fig. 1
PRO-25-017-02	Standard, Fig. 2
PRO-25-017-03	Standard, Fig. 3

Mod. Vienna Nasal Specula
Set of 3

Catalog #	Size
PRO-25-021-10	Standard



Mod. Vienna Nasal Speculum



Catalog #	Blade Length, Profile
PRO-25-023-01	27 mm, Fig. 1
PRO-25-023-02	31 mm, Fig. 2
PRO-25-023-03	35 mm, Fig. 3



Hartmann-Halle Nasal Speculum

Set of 3

Catalog #	Size, Blade Length, Profile
PRO-25-033-01	15.5 cm (6") , 27 mm, Fig. 1
PRO-25-033-02	15.5 cm (6") , 31 mm, Fig. 2
PRO-25-033-03	15.5 cm (6") , 35 mm, Fig. 3



Martin Nasal Specula

Catalog #	Size, Blade Length
PRO-25-035-13	13 cm (5") , 17 mm

**Martin Nasal Specula
Bent Sideways**

Catalog #	Size, Blade Length
PRO-25-037-13	12.5 cm (5") , 17 mm





Tieck-Halle Nasal Specula

Catalog #	Size, Blade Length
PRO-25-041-13	13 cm (5") , 16 mm

Killian Nasal Speculum

Catalog #	Size, Blade Length, Profile
PRO-25-053-01	13 cm (5"), 35 mm, Fig. 1
PRO-25-053-02	13 cm (5"), 50 mm, Fig. 2
PRO-25-053-03	13 cm (5"), 75 mm, Fig. 3
PRO-25-053-04	13 cm (5"), 85 mm, Fig. 4



Cottle Nasal Speculum

Catalog #	Size, Blade Length, Profile
PRO-25-063-01	13.5 cm (5 1/4"), 35 mm, Fig. 1
PRO-25-063-02	13.5 cm (5 1/4"), 50 mm, Fig. 2
PRO-25-063-03	13.5 cm (5 1/4"), 75 mm, Fig. 3
PRO-25-063-04	14.5 cm (5 3/4"), 85 mm, Fig. 4



Cottle Nasal Speculum
With Screw Fixation

Catalog #	Size, Blade Length, Profile
PRO-25-067-01	13.5 cm (5 ¼"), 35 mm, Fig. 1
PRO-25-067-02	13.5 cm (5 ¼"), 50 mm, Fig. 2
PRO-25-067-03	13.5 cm (5 ¼"), 75 mm, Fig. 3
PRO-25-067-04	14.5 cm (5 ¾"), 85 mm, Fig. 4



Cottle Nasal Specula
Black

Catalog #	Size, Blade Length
PRO-25-073-45	13.5 cm (5 ¼"), 45 mm
PRO-25-073-75	14 cm (5 ½"), 75 mm



Krause Polypus Snare

Catalog #	Size, Shaft Diameter
PRO-25-091-26	26 cm (10 ¼"), Ø 3.0 mm



Krause-Voss Polypus Snare

Catalog #	Size, Shaft Diameter
PRO-25-093-26	26 cm (10 ¼"), Ø 3.0 mm



Lange-Wilde Polypus Snare

Catalog #	Size
PRO-25-095-24	24 cm (9 ½")

Polypus Wire
Bundle with 12 Pieces

Catalog #	Size
PRO-25-097-12	10.5 cm (4"), Ø 0.3





Troeltsch Nasal Tampon Forcep

Catalog #	Size
PRO-25-101-15	14.5 cm (5 ¾")



Troeltsch Nasal Tampon Forcep

Catalog #	Size
PRO-25-103-18	18 cm (7")



Gruenwald (Jansen) Nasal Tampon Forcep

Catalog #	Size
PRO-25-105-21	21.5 cm (8 ½")



**Nasal Tampon Forcep
Smooth Jaws**

Catalog #	Size
PRO-25-107-16	16 cm (6 ¼")



Nasal Tampon Forcep
1 x 2 Teeth

Catalog #	Size
PRO-25-109-16	16 cm (6 ¼")



Nasal Tampon Forcep
Smooth Jaws

Catalog #	Size
PRO-25-111-18	18.5 cm (7 ¼")



Nasal Tampon Forcep
1 x 2 Teeth

Catalog #	Size
PRO-25-113-20	20 cm (8")

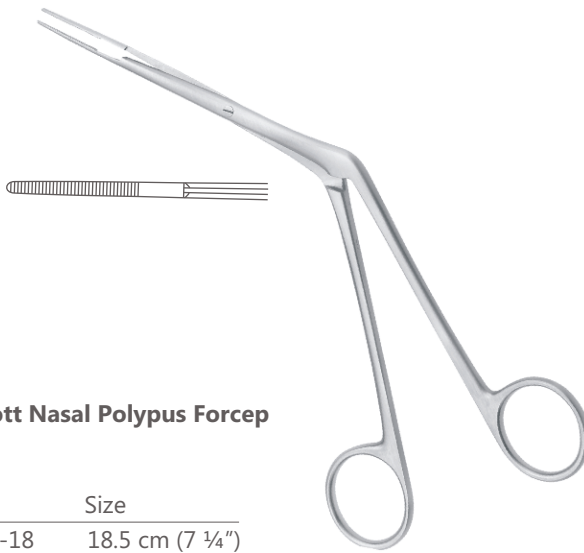

Westmoacott Nasal Polypus Forcep

Catalog #	Size
PRO-25-121-18	18.5 cm (7 ¼")

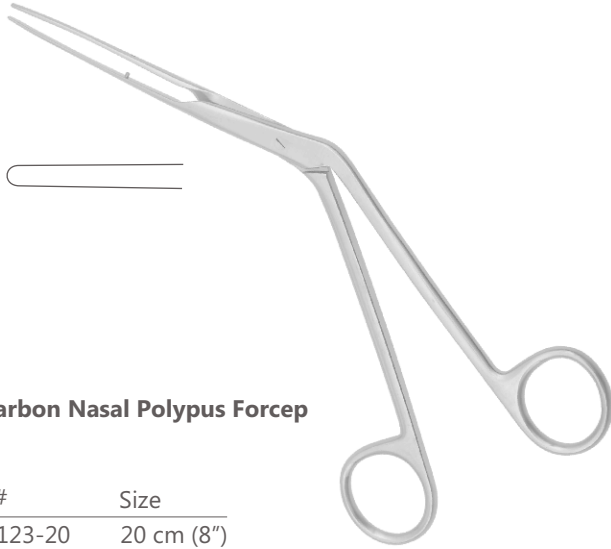

Lubet-Barbon Nasal Polypus Forcep

Catalog #	Size
PRO-25-123-20	20 cm (8")

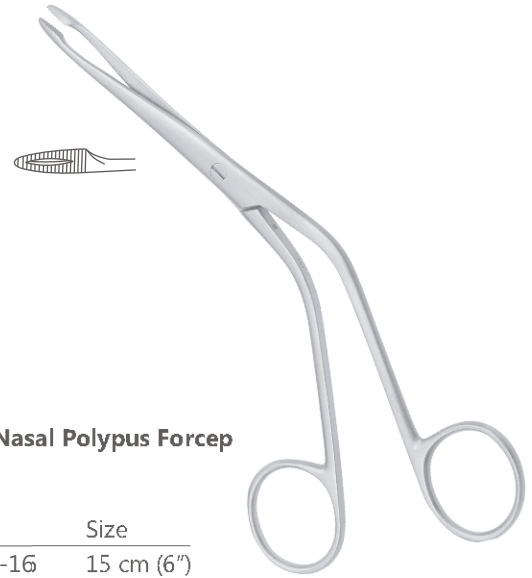

Hartmann Nasal Polypus Forcep

Catalog #	Size
PRO-25-127-16	15 cm (6")

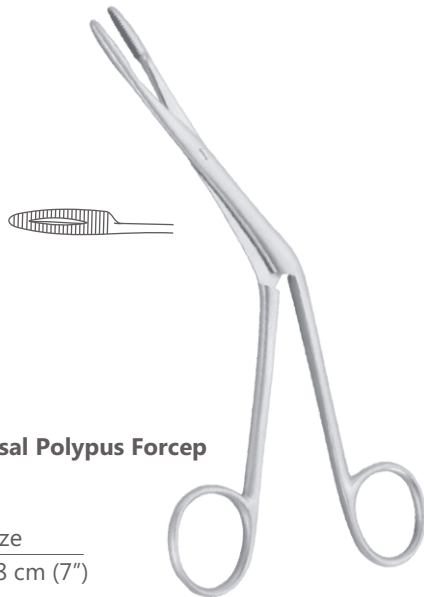

Heymann-Knight Nasal Polypus Forcep

Catalog #	Size
PRO-25-129-18	18 cm (7")

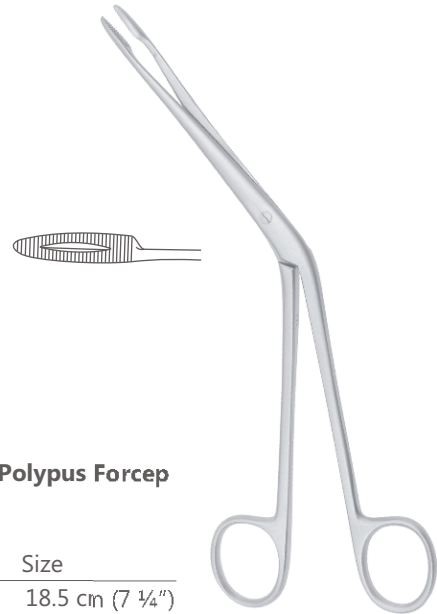

Hartmann Nasal Polypus Forcep

Catalog #	Size
PRO-25-131-20	18.5 cm (7 ¼")

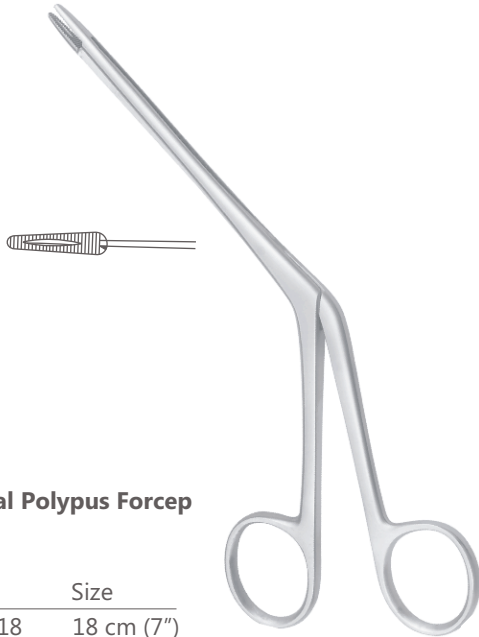

Littauer Nasal Polypus Forcep

Catalog #	Size
PRO-25-133-18	18 cm (7")

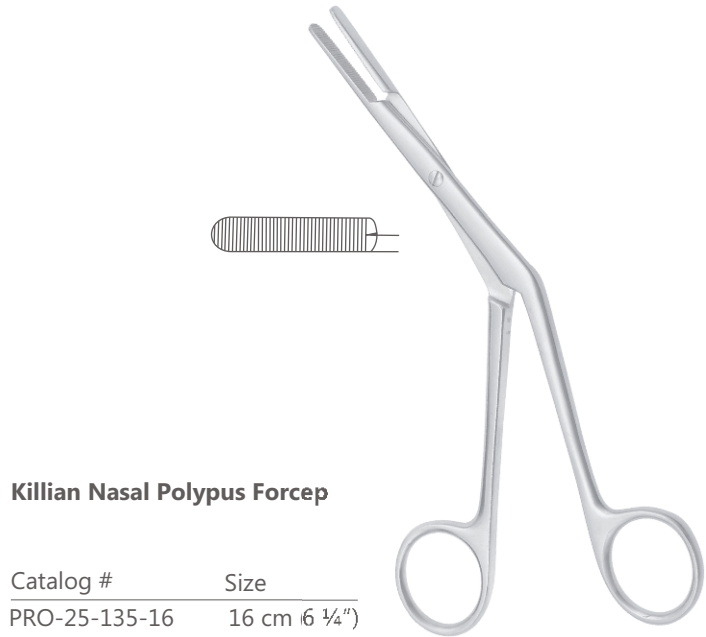

Killian Nasal Polypus Forcep

Catalog #	Size
PRO-25-135-16	16 cm (6 ¼")



Heymann Septum Forcep

Catalog #	Size, Profile
PRO-25-161-01	18 cm (7"), Fig. 1
PRO-25-161-02	18 cm (7"), Fig. 2
PRO-25-161-03	18 cm (7"), Fig. 3

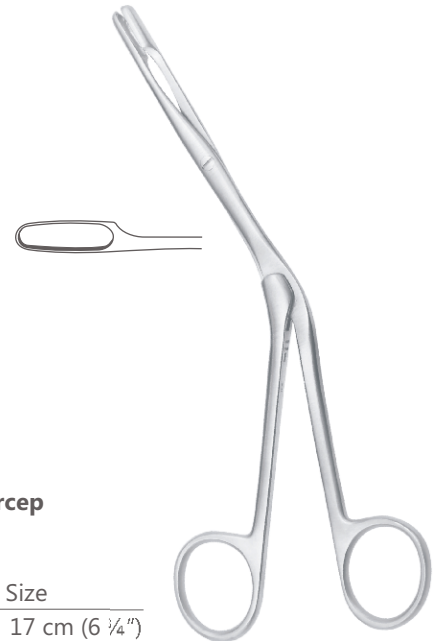

Knight Septum Forcep

Catalog #	Size
PRO-25-165-17	17 cm (6 ¾")

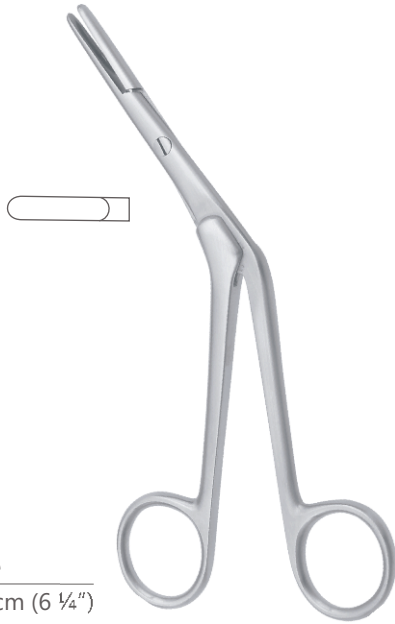

Craig Septum Forcep

Catalog #	Size
PRO-25-167-16	16 cm (6 ¼")

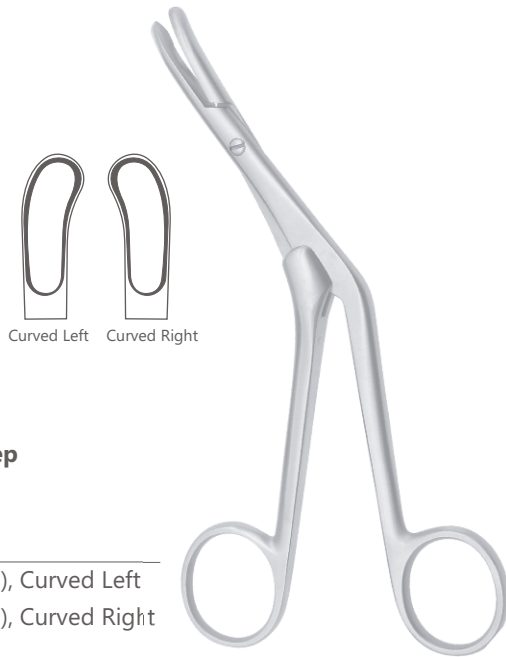

Craig-Dominick Ethmoid Forcep

Catalog #	Size, Profile
PRO-25-169-01	16 cm (6 ¼"), Curved Left
PRO-25-169-02	16 cm (6 ¼"), Curved Right

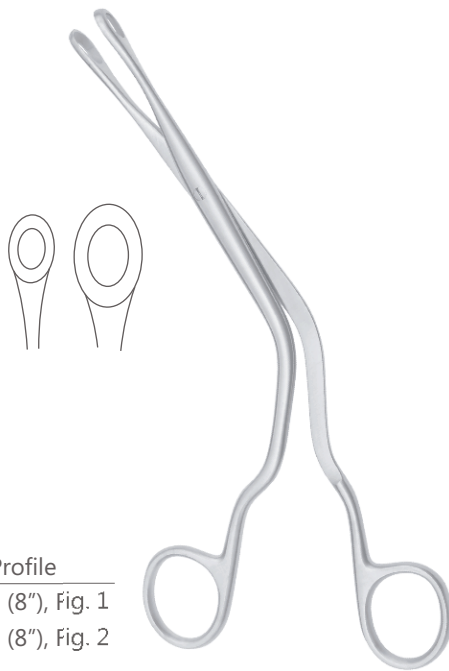

Luc Ethmoid Forcep
Fenestrated

Catalog #	Size, Profile
PRO-25-171-01	20 cm (8"), Fig. 1
PRO-25-171-02	20 cm (8"), Fig. 2

Luce Thmoid Forcep

Catalog #	Size, Profile
PRO-25-173-01	20 cm (8"), fig. 1
PRO-25-173-02	20 cm (8"), fig. 2

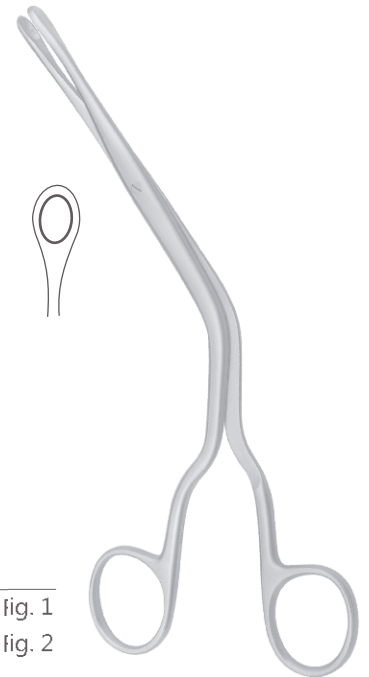

Bruenings Ethmoid Forcep

Catalog #	Size, Profile
PRO-25-175-01	16.5 cm (6 1/2"), Fig. 1
PRO-25-175-04	16.5 cm (6 1/2"), Fig. 2
PRO-25-175-05	16.5 cm (6 1/2"), Fig. 3
PRO-25-175-06	16.5 cm (6 1/2"), Fig. 4

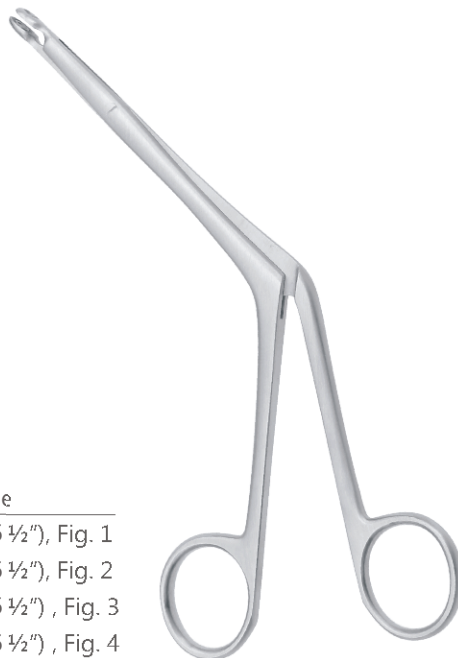

Takahashi Ethmoid Forcep
Straight

Catalog #	Size
PRO-25-181-12	12 cm (4 3/4")





Takahashi Ethmoid Forcep
Bent Upwards

Catalog #	Size
PRO-25-183-12	12 cm (4 ¾")



Waston-Williams Ethmoid Forcep

Catalog #	Size
PRO-25-191-19	12 cm (4 ¾")



Waston-Williams Ethmoid Forcep

Catalog #	Size
PRO-25-193-19	12 cm (4 ¾")

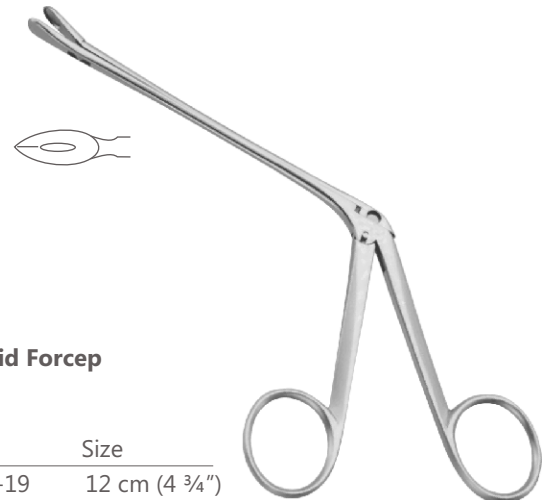

Weil Ethmoid Forcep
With Neck

Catalog #	Size
PRO-25-195-19	12 cm (4 ¾")



Weil-Blakesley Nasal Cutting Forcep
Straight

Catalog #	Size, Bite Size, Profile
PRO-25-201-01	12 cm (4 ¾"), 3.0 mm, Fig. 1
PRO-25-201-02	12 cm (4 ¾"), 3.5 mm, Fig. 2
PRO-25-201-03	12 cm (4 ¾"), 4.5 mm, Fig. 3
PRO-25-201-04	12 cm (4 ¾"), 5.0 mm, Fig. 4
PRO-25-201-05	12 cm (4 ¾"), 5.5 mm, Fig. 5

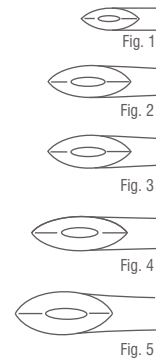

Weil-Blakesley Nasal Cutting Forcep
Angled 45°

Catalog #	Size, Bite Size, Profile
PRO-25-203-01	12 cm (4 ¾"), 3.0 mm, Fig. 1
PRO-25-203-02	12 cm (4 ¾"), 3.5 mm, Fig. 2
PRO-25-203-03	12 cm (4 ¾"), 4.5 mm, Fig. 3
PRO-25-203-04	12 cm (4 ¾"), 5.0 mm, Fig. 4



Weil-Blakesley Nasal Cutting Forcep
Angled 90°

Catalog #	Size, Bite Size, Profile
PRO-25-205-01	12 cm (4 ¾"), 3.0 mm, Fig. 1
PRO-25-205-02	12 cm (4 ¾"), 3.0 mm, Fig. 2
PRO-25-205-03	12 cm (4 ¾"), 4.5 mm, Fig. 3
PRO-25-205-04	12 cm (4 ¾"), 5.0 mm, Fig. 4



Strucken Nasal Cutting Forcep

Catalog #	Size, Bite Size, Profile
PRO-25-231-01	12 cm (4 ¾"), 0.9 mm, Fig. 1
PRO-25-231-02	12 cm (4 ¾"), 1.2 mm, Fig. 2

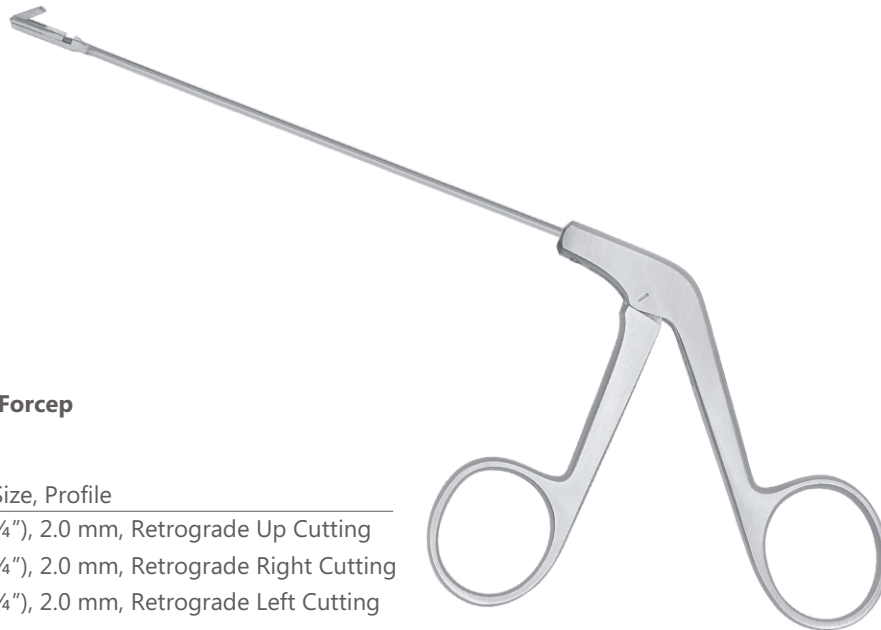

Stammberger Nasal Cutting Forcep

Catalog #	Size, Bite Size, Profile
PRO-25-235-01	12 cm (4 ¾"), 2.0 mm, Retrograde Up Cutting
PRO-25-235-02	12 cm (4 ¾"), 2.0 mm, Retrograde Right Cutting
PRO-25-235-03	12 cm (4 ¾"), 2.0 mm, Retrograde Left Cutting

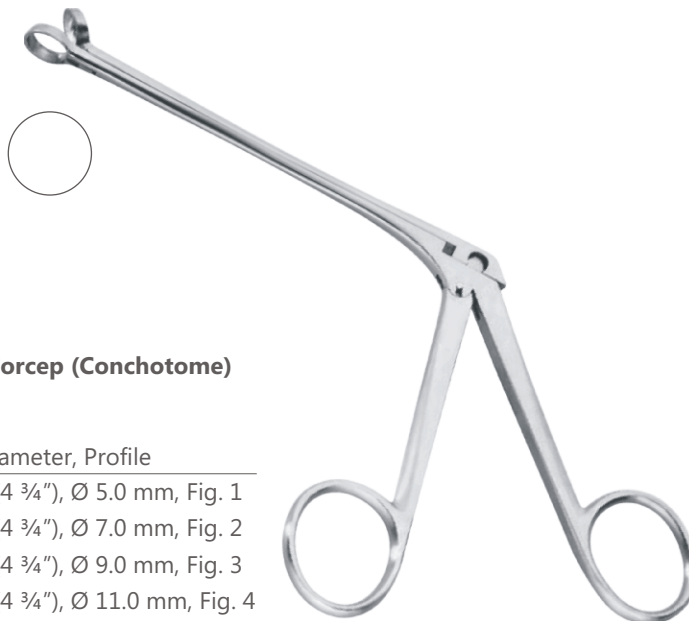

Hartmann Nasal Cutting Forcep (Conchotome)

Catalog #	Size, Diameter, Profile
PRO-25-241-01	12 cm (4 ¾"), Ø 5.0 mm, Fig. 1
PRO-25-241-02	12 cm (4 ¾"), Ø 7.0 mm, Fig. 2
PRO-25-241-03	12 cm (4 ¾"), Ø 9.0 mm, Fig. 3
PRO-25-241-04	12 cm (4 ¾"), Ø 11.0 mm, Fig. 4



Schmeden Nasal Cutting Forcep

Catalog #	Size, Diameter
PRO-25-245-12	12 cm (4 ¾"), Ø 8.0 mm

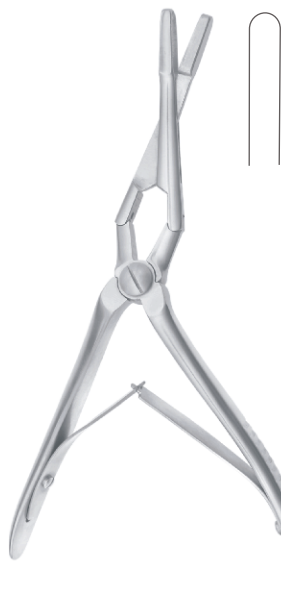

Jensen-Middelton Septum Forcep
Through Cutting Jaws

Catalog #	Size
PRO-25-281-19	19 cm (7 ½")

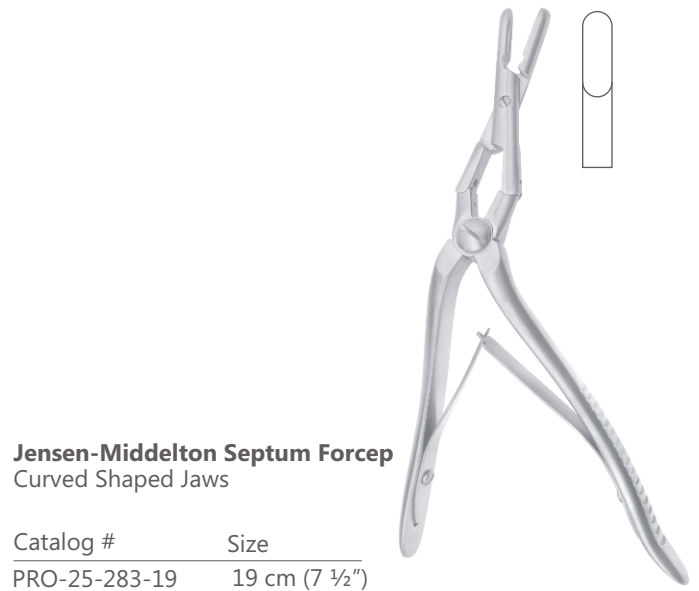

Jensen-Middelton Septum Forcep
Curved Shaped Jaws

Catalog #	Size
PRO-25-283-19	19 cm (7 ½")



UltraGrip™ TC Rubin Septum Forcep

Catalog #	Size
PRO-25-291-21	21 cm (8 ¼")

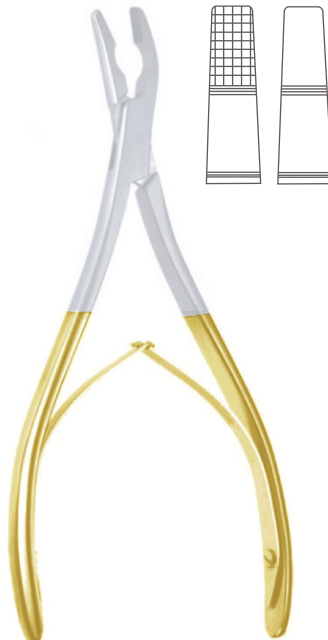

UltraGrip™ TC Lower Lateral Morseliser

Catalog #	Size
PRO-25-293-21	19 cm (7 ½")

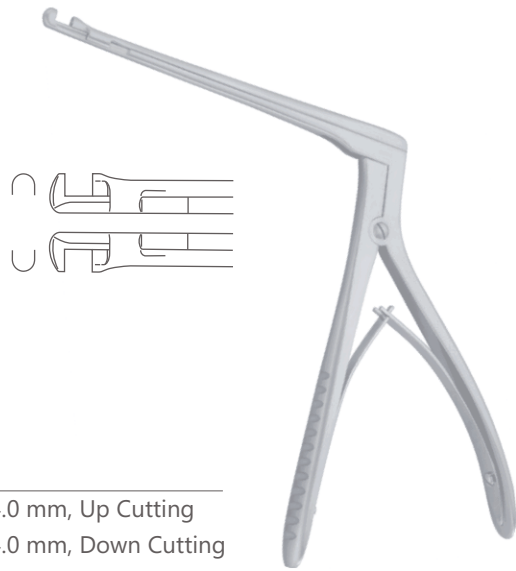

Hajek Sphenoid Punch

Catalog #	Size, Bite Size, Profile
PRO-25-301-01	14 cm (5 1/2"), 4.0 mm x 4.0 mm, Up Cutting
PRO-25-301-02	14 cm (5 1/2"), 4.0 mm x 4.0 mm, Down Cutting

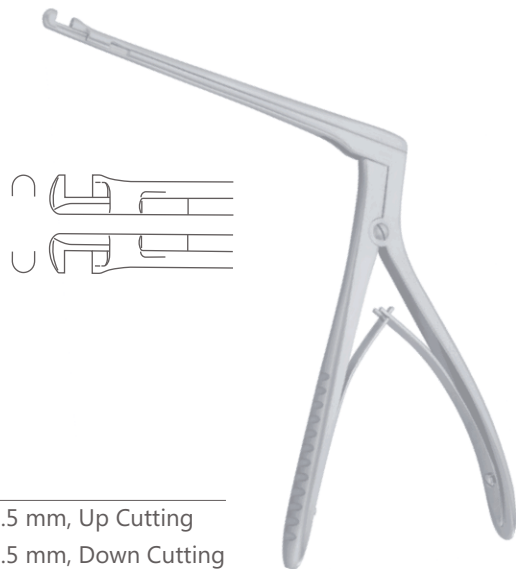

Hajek-Kofler Sphenoid Punch

Catalog #	Size, Bite Size, Profile
PRO-25-303-01	14 cm (5 1/2"), 3.5 mm x 3.5 mm, Up Cutting
PRO-25-303-02	14 cm (5 1/2"), 3.5 mm x 3.5 mm, Down Cutting



Kerrison Sphenoid Punch
Up Cutting

Catalog #	Size, Diameter
PRO-25-305-03	14 cm (5 ½"), Ø 3.0 mm x 3.0 mm
PRO-25-305-04	9 cm (3 ½"), Ø 4.0 mm x 4.0 mm
PRO-25-305-05	9 cm (3 ½"), Ø 5.0 mm x 5.0 mm
PRO-25-305-06	9 cm (3 ½"), Ø 6.0 mm x 6.0 mm

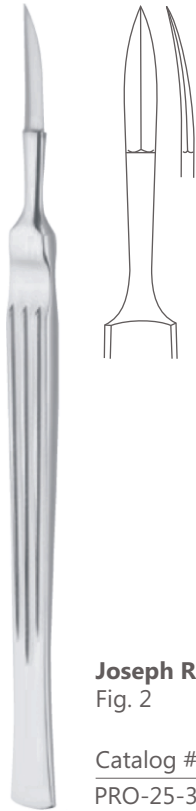

Joseph Rhinoplastic Knife
Fig. 1

Catalog #	Size
PRO-25-350-15	15 cm (6")

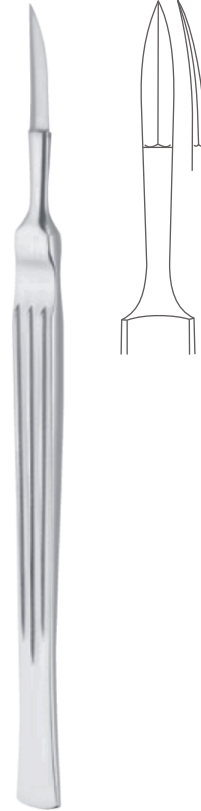

Joseph Rhinoplastic Knife
Fig. 2

Catalog #	Size
PRO-25-351-15	15 cm (6")

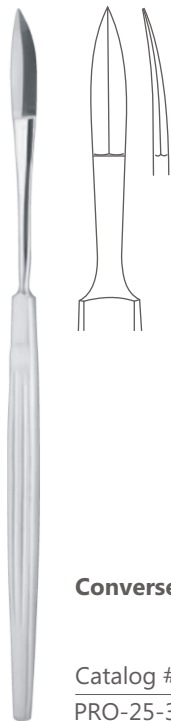

Fomon Rhinoplastic Knife

Catalog #	Size
PRO-25-355-15	16.5 cm (6 1/2")



Converse Rhinoplastic Knife

Catalog #	Size
PRO-25-361-16	16 cm (6 1/4")



Joseph Rhinoplastic Knife

Catalog #	Size
PRO-25-365-15	15 cm (6")



Cottle Rhinoplastic Knife

Catalog #	Size
PRO-25-367-15	14 cm (5 ½")



Freer Mucosa Knife

Catalog #	Size
PRO-25-369-15	16.5 cm (6 ½")



Freer Septum Knife

Catalog #	Size
PRO-25-371-01	18 cm (7")
PRO-25-371-02	18 cm (7")

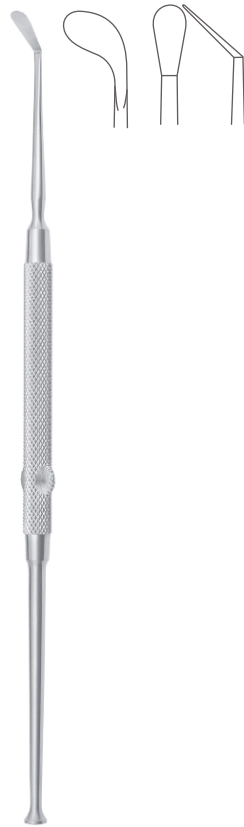

Freer Septum Knife

Catalog #	Size
PRO-25-373-01	18 cm (7")
PRO-25-373-02	19 cm (7 ½")



Ballanger Swivel Knife
Straight

Catalog #	Size, Cutting Edge Size
PRO-25-380-03	21 cm (8 ¼"), 3.0 mm
PRO-25-380-04	21 cm (8 ¼"), 4.0 mm
PRO-25-380-05	21 cm (8 ¼"), 5.0 mm

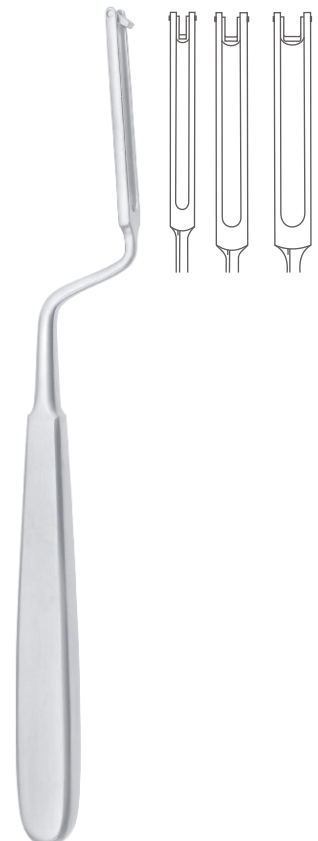

Ballanger Swivel Knife
Bayonet Shaped

Catalog #	Size, Cutting Edge Size
PRO-25-381-03	20 cm (8"), 3.0 mm
PRO-25-381-04	20 cm (8"), 4.0 mm
PRO-25-381-05	20 cm (8"), 5.0 mm



McKenty Septum Elevator

Catalog #	Size, Blade Size
PRO-25-451-04	15 cm (6"), 4.0 mm
PRO-25-451-05	15 cm (6"), 5.0 mm



Halle Septum Elevator

Catalog #	Size, Blade Size
PRO-25-455-16	16 cm (6 1/4"), 3.5 mm



Joseph Septum Elevator

Catalog #	Size, Blade Size
PRO-25-461-16	16 cm (6 1/4"), 4.0 mm



Freer Septum Elevator

Catalog #	Size, Blade Size, Profile
PRO-25-471-19	19 cm (7 1/2"), 5.0 mm, Sharp
PRO-25-473-19	19 cm (7 1/2"), 6.0 mm, Blunt

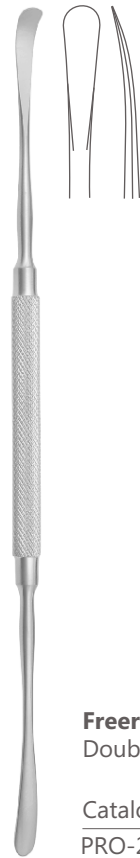

Freer Septum Elevator
Double Ended, Sharpe/Blunt

Catalog #	Size, Blade Size 1, Blade Size 2
PRO-25-475-18	18.5 cm (7 ¼"), 5.0 mm, 5.0 mm

Freer Septum Elevator
Double Ended, Sharpe/Blunt

Catalog #	Size, Blade Size 1, Blade Size 2
PRO-25-477-20	20.5 cm (8"), 6.0 mm, 5.0 mm

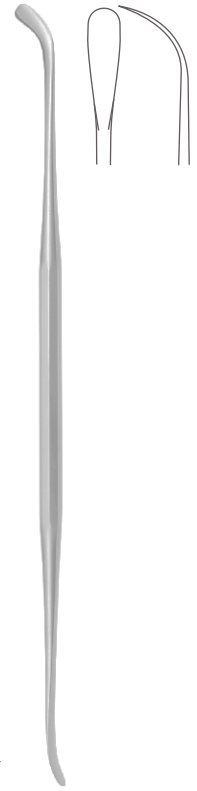

McKenty Septum Elevator

Catalog #	Size, Blade Size 1, Blade Size 2
PRO-25-479-20	20.5 cm (8"), 4.0 mm, 4.0 mm

Ballanger-Hajek Septum Elevator

Catalog #	Size, Blade Size 1, Blade Size 2
PRO-25-482-19	19 cm (7 ½"), 6.0 mm, 6.0 mm



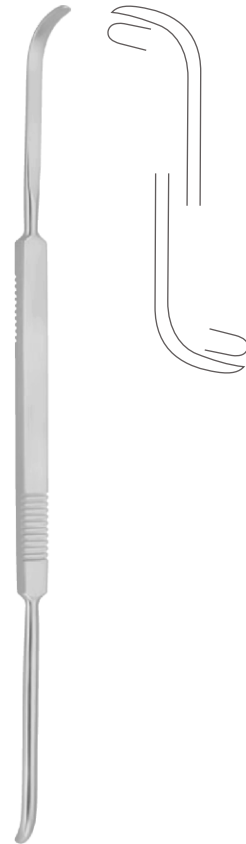

Cottle Septum Elevator

Catalog #	Size, Blade Size 1, Blade Size 2
PRO-25-501-23	23.5 cm (9 1/4"), 5.0 mm , 5.0 mm

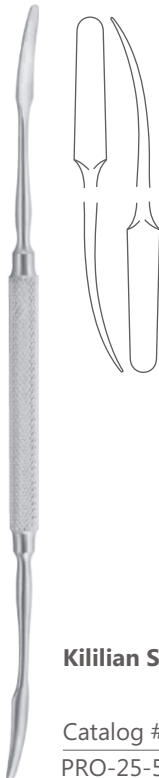

Kilian Septum Elevator

Catalog #	Size, Blade Size 1, Blade Size 2
PRO-25-503-18	18 cm (7"), 4.0 mm , 4.0 mm

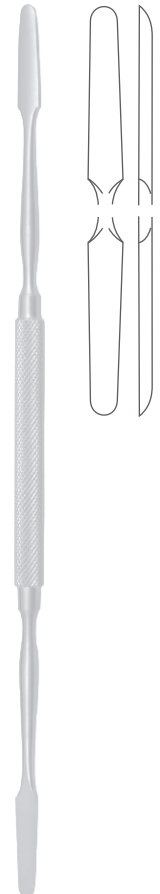

Kilian Septum Elevator

Catalog #	Size, Blade Size 1, Blade Size 2
PRO-25-505-23	23 cm (9"), 4.5 mm , 4.5 mm

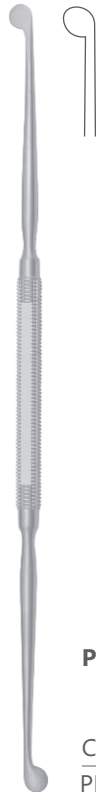

Pierce Septum Elevator

Catalog #	Size, Blade Size 1, Blade Size 2
PRO-25-507-21	21.5 cm (8 ½"), 4.0 mm , 4.0 mm

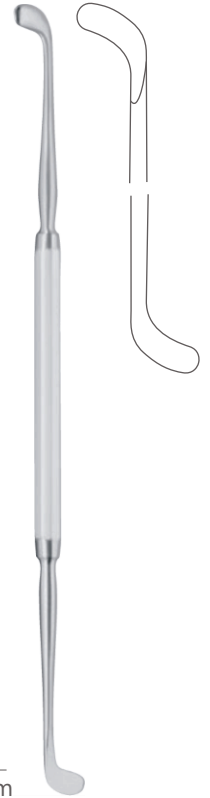

Pennington Septum Elevator

Catalog #	Size, Blade Size 1, Blade Size 2
PRO-25-509-21	21.5 cm (8 ½"), 4.0 mm , 4.0 mm

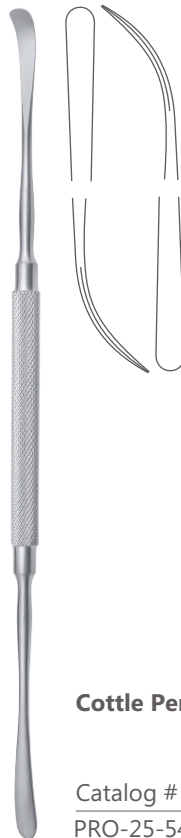

Roger Periosteal Elevator

Catalog #	Size, Blade Size 1, Blade Size 2
PRO-25-511-19	19.5 cm (7 ¾"), 4.0 mm , 4.0 mm



Cottle Periosteal Elevator

Catalog #	Size, Blade Size 1, Blade Size 2
PRO-25-541-22	23 cm (9"), 3.3 mm , 3.7 mm

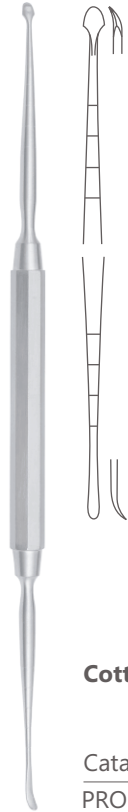

Masing Periosteal Elevator

Catalog #	Size, Blade Size 1, Blade Size 2
PRO-25-543-21	19.5 cm (7 3/4"), 3.0 mm , 2.0 mm

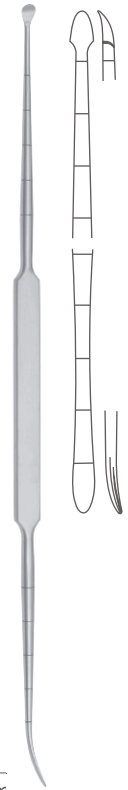

Cottle Periosteal Elevator

Catalog #	Size, Blade Size 1, Blade Size 2
PRO-25-545-21	19.5 cm (7 3/4"), 4.5 mm , 4.5 mm



Howarth Periosteal Elevator

Catalog #	Size
PRO-25-547-21	21.5 cm (8 1/2")



Joseph Periosteal Elevator

Catalog #	Size, Blade Width
PRO-25-551-16	18 cm (7"), 6.0 mm



Freer Septum Chisel
Straight

Catalog #	Size, Blade Width
PRO-25-600-16	16.5 cm (6 1/2"), 4.0 mm



Freer Septum Chisel
Curved

Catalog #	Size, Blade Width
PRO-25-601-16	16.5 cm (6 1/2"), 4.0 mm



West Septum Chisel

Catalog #	Size
PRO-25-604-16	16 cm (6 1/4")



West Septum Gouge

Catalog #	Size
PRO-25-605-16	16 cm (6 1/4")



Freer Septum Gouge

Catalog #	Size, Blade Width
PRO-25-608-16	15 cm (6"), 6.0 mm

Ballenger Septum Gouge

Catalog #	Size, Blade Width
PRO-25-610-02	15 cm (6"), 2.0 mm
PRO-25-610-04	15 cm (6"), 4.0 mm
PRO-25-610-06	15 cm (6"), 6.0 mm
PRO-25-610-08	15 cm (6"), 8.0 mm

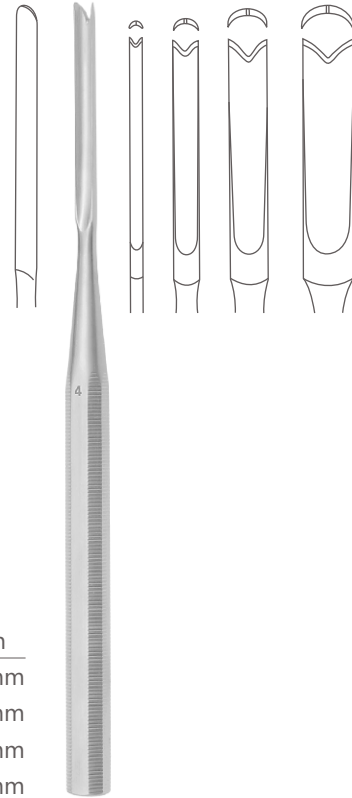

Killian Septum Gouge
Bayonet Shaped

Catalog #	Size, Blade Width
PRO-25-613-16	16 cm (6 ¼"), 8.0 mm

Killian-Claus Septum Gouge
Bayonet Shaped

Catalog #	Size, Blade Width
PRO-25-615-16	16 cm (6 ¼"), 5.0 mm



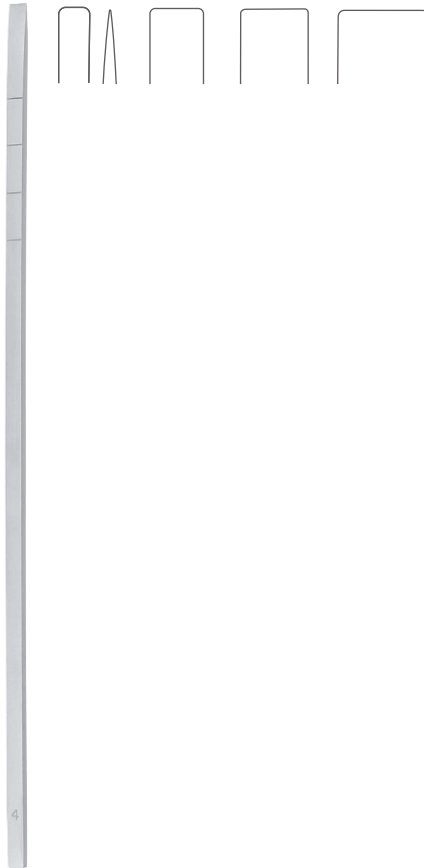

Cottle Osteotome
Straight

Catalog #	Size, Blade Width
PRO-25-620-04	18.5 cm (7 1/4"), 4.0 mm
PRO-25-620-07	18.5 cm (7 1/4"), 7.0 mm
PRO-25-620-09	18.5 cm (7 1/4"), 9.0 mm
PRO-25-620-12	18.5 cm (7 1/4"), 12.0 mm



Cottle Osteotome
Curved

Catalog #	Size, Blade Width
PRO-25-621-06	18.5 cm (7 1/4"), 6.0 mm

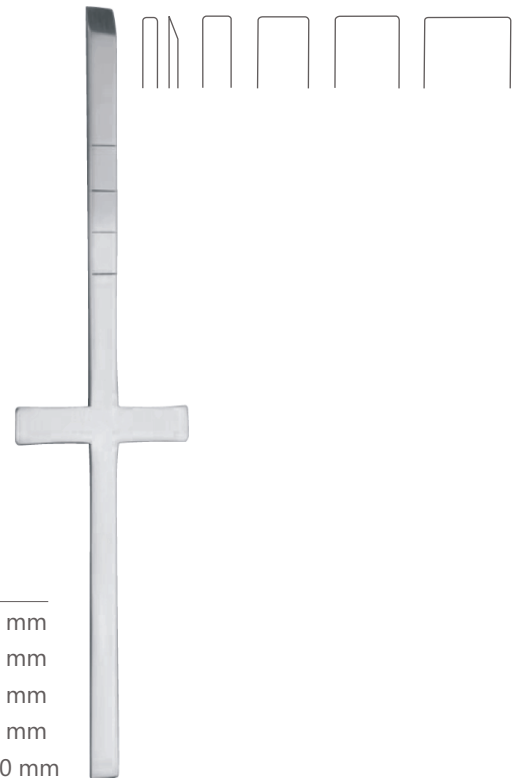

Cottle Chisel
Straight , Cross Handle

Catalog #	Size, Blade Width
PRO-25-626-02	18.5 cm (7 1/4"), 2.0 mm
PRO-25-626-04	18.5 cm (7 1/4"), 4.0 mm
PRO-25-626-07	18.5 cm (7 1/4"), 7.0 mm
PRO-25-626-09	18.5 cm (7 1/4"), 9.0 mm
PRO-25-626-12	18.5 cm (7 1/4"), 12.0 mm

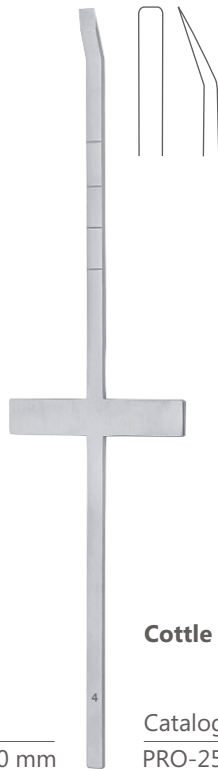

Cottle Chisel
Curved, Cross Handle

Catalog #	Size, Blade Width
PRO-25-627-06	18.5 cm (7 ¼"), 6.0 mm

Cottle Osteotome

Catalog #	Size, Blade Width
PRO-25-630-16	18.5 cm (7 ¼"), 16.0 mm



Cottle Osteotome
Cross Handle

Catalog #	Size, Blade Width
PRO-25-632-16	18.5 cm (7 ¼"), 16.0 mm

Rubin Osteotome

Catalog #	Size, Blade Width
PRO-25-636-10	18.5 cm (7 ¼"), 10.0 mm
PRO-25-636-12	18.5 cm (7 ¼"), 12.0 mm
PRO-25-636-14	18.5 cm (7 ¼"), 14.0 mm

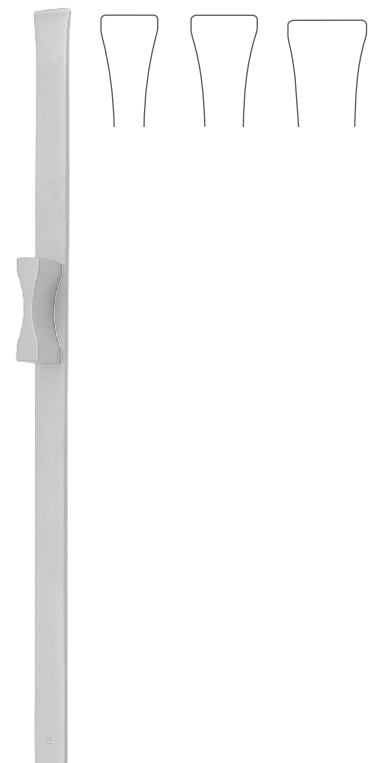



Walter Chisel

Catalog #	Size, Blade Width
PRO-25-640-03	9 cm (7 1/2"), 3.0 mm
PRO-25-640-04	9 cm (7 1/2"), 4.5 mm

Walter Osteotome

Catalog #	Size, Blade Width
PRO-25-642-03	19 cm (7 1/2"), 3.0 mm
PRO-25-642-04	19 cm (7 1/2"), 4.0 mm
PRO-25-642-07	19 cm (7 1/2"), 7.0 mm
PRO-25-642-09	19 cm (7 1/2"), 9.0 mm
PRO-25-642-12	19 cm (7 1/2"), 12.0 mm



Fomon Chisel

Catalog #	Size, Blade Width
PRO-25-648-04	16 cm (6 1/4"), 4.0 mm
PRO-25-648-05	16 cm (6 1/4"), 5.0 mm
PRO-25-648-06	16 cm (6 1/4"), 6.0 mm
PRO-25-648-07	16 cm (6 1/4"), 7.0 mm

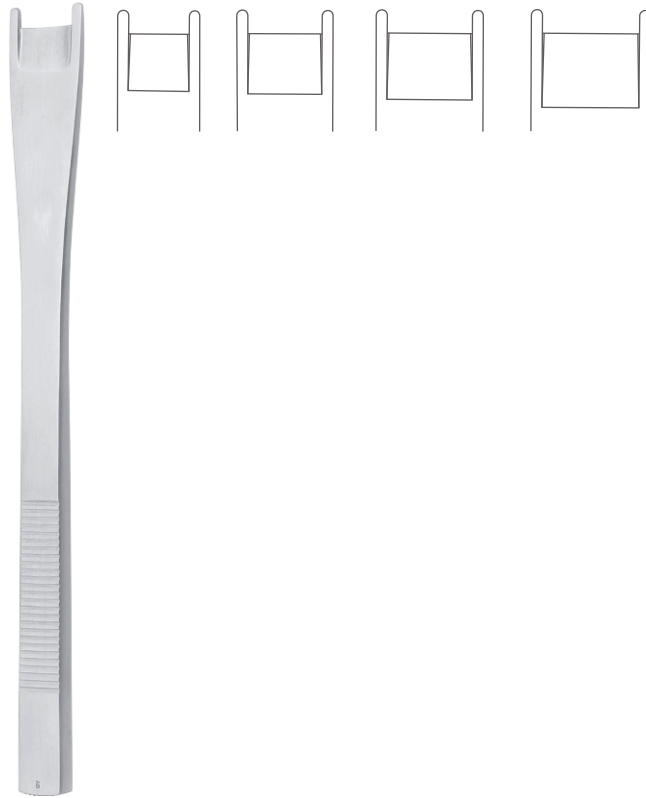

Cinelli Osteotome

Catalog #	Size, Blade Width
PRO-25-650-10	16 cm (6 1/4"), 10.0 mm
PRO-25-650-12	16 cm (6 1/4"), 12.0 mm
PRO-25-650-14	16 cm (6 1/4"), 14.0 mm
PRO-25-650-16	16 cm (6 1/4"), 16.0 mm

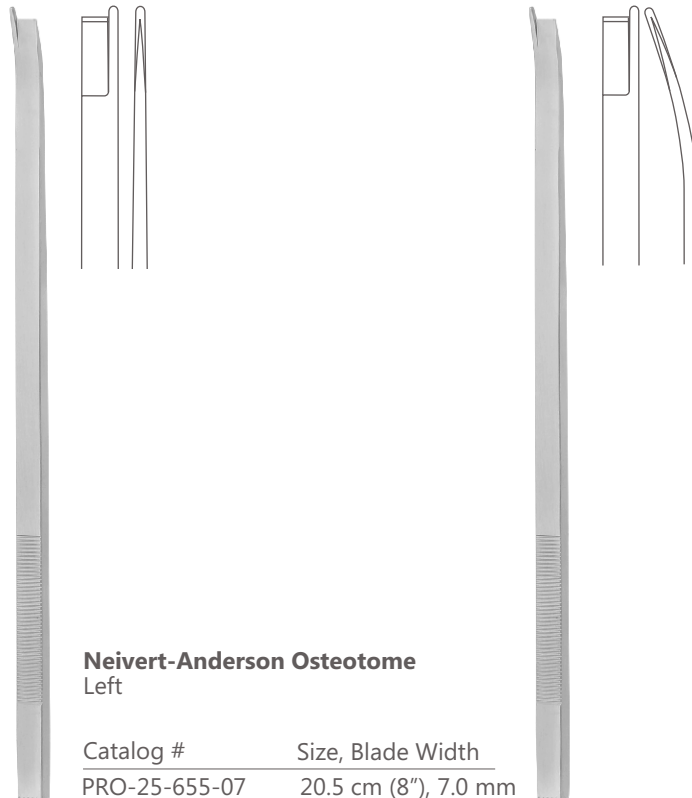

**Neivert-Anderson Osteotome
Straight**

Catalog #	Size, Blade Width
PRO-25-654-07	20.5 cm (8"), 7.0 mm

**Neivert-Anderson Osteotome
Left**

Catalog #	Size, Blade Width
PRO-25-655-07	20.5 cm (8"), 7.0 mm

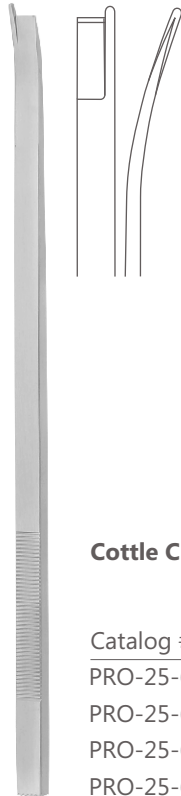

Cottle Chisel

Catalog #	Size, Blade Width
PRO-25-660-04	18 cm (7"), 4.0 mm
PRO-25-660-07	18 cm (7"), 7.0 mm
PRO-25-660-09	18 cm (7"), 9.0 mm
PRO-25-660-12	18 cm (7"), 12.0 mm



Neivert-Anderson Osteotome Right

Catalog #	Size, Blade Width
PRO-25-657-07	20.5 cm (8"), 7.0 mm

Sheehan Osteotome

Catalog #	Size, Blade Width
PRO-25-664-01	15 cm (6"), 1.0 mm
PRO-25-664-02	15 cm (6"), 2.0 mm
PRO-25-664-03	15 cm (6"), 3.0 mm
PRO-25-664-04	15 cm (6"), 4.0 mm
PRO-25-664-05	15 cm (6"), 5.0 mm
PRO-25-664-06	15 cm (6"), 6.0 mm
PRO-25-664-07	15 cm (6"), 7.0 mm
PRO-25-664-08	15 cm (6"), 8.0 mm
PRO-25-664-10	15 cm (6"), 10.0 mm
PRO-25-664-12	15 cm (6"), 12.0 mm

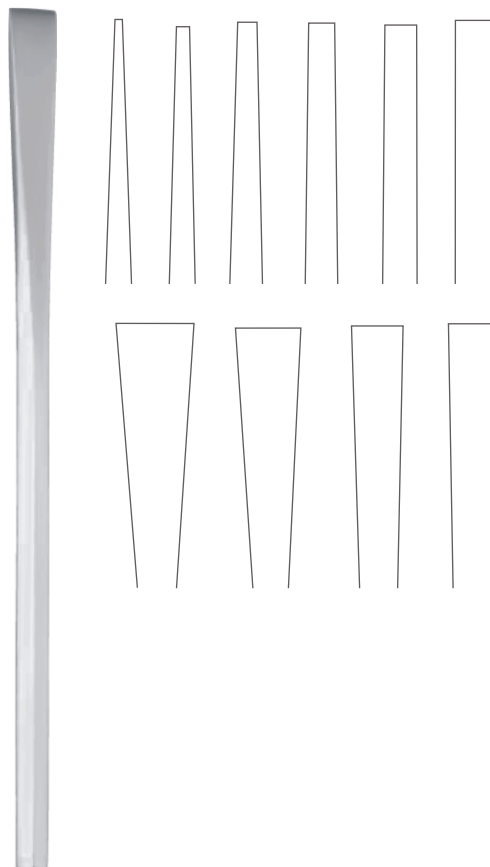



Silver Chisel
Straight

Catalog #	Size, Blade Width
PRO-25-666-05	18 cm (7"), 5.0 mm

Silver Chisel
Right

Catalog #	Size, Blade Width
PRO-25-667-05	18 cm (7"), 5.0 mm



Silver Chisel
Left Curved

Catalog #	Size, Blade Width
PRO-25-669-05	18 cm (7"), 5.0 mm

Parkes Osteotome

Catalog #	Size
PRO-25-672-01	16 cm (6 ¼")



Joseph Nasal Saw

Catalog #	Size, Profile
PRO-25-691-01	17 cm (6 ¾"), Angled to Left
PRO-25-691-02	17 cm (6 ¾"), Angled to Right

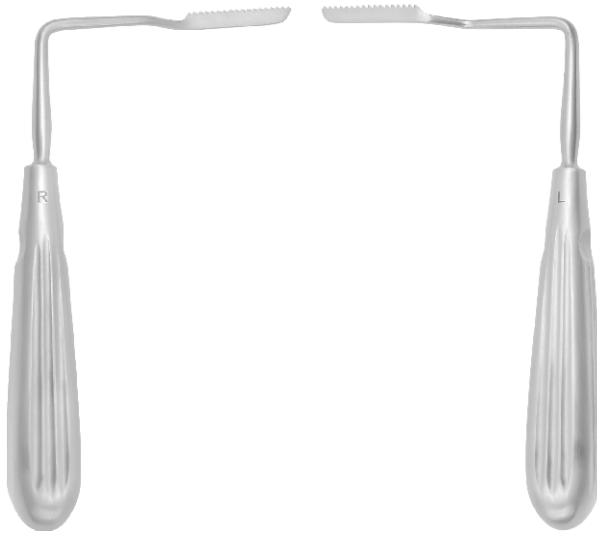

**Joseph Nasal Saw
Straight**

Catalog #	Size, Working Length
PRO-25-692-19	19 cm (7 ½"), 40.0 mm



**Joseph Nasal Saw
Bayonet Shaped**

Catalog #	Size, Working Length
PRO-25-693-01	19 cm (7 ½"), 40.0 mm
PRO-25-693-02	19 cm (7 ½"), 40.0 mm



Cottle Cartilage Crusher



Catalog #	Size
PRO-25-698-00	Standard

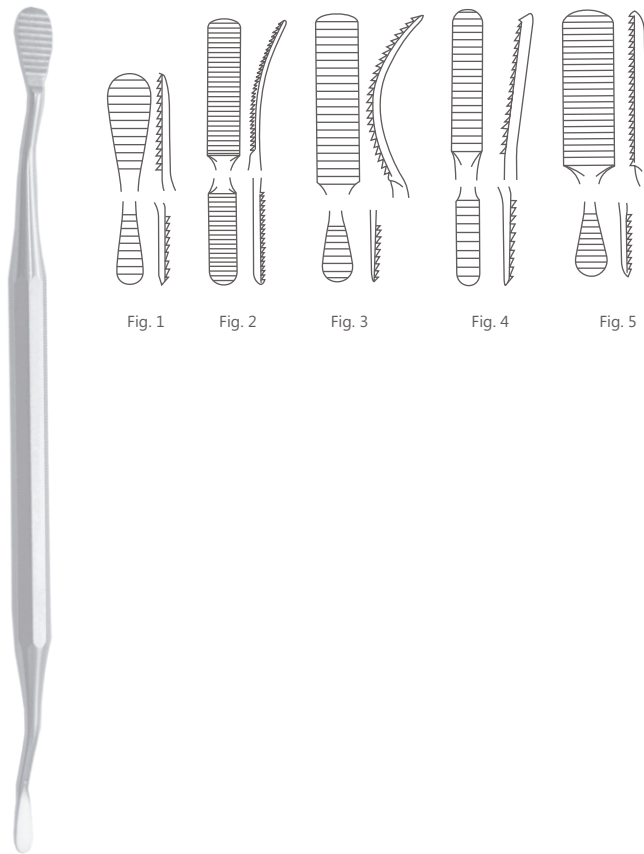

Miller-Colburn Bone File
Drawing Cut

Catalog #	Size, Profile
PRO-25-701-01	18 cm (7"), Fig. 1
PRO-25-701-02	18 cm (7"), Fig. 2
PRO-25-701-03	18 cm (7"), Fig. 3
PRO-25-701-04	18 cm (7"), Fig. 4
PRO-25-701-05	18 cm (7"), Fig. 5

Fig. 1

Fig. 2

Fig. 3

Fig. 4

Fig. 5

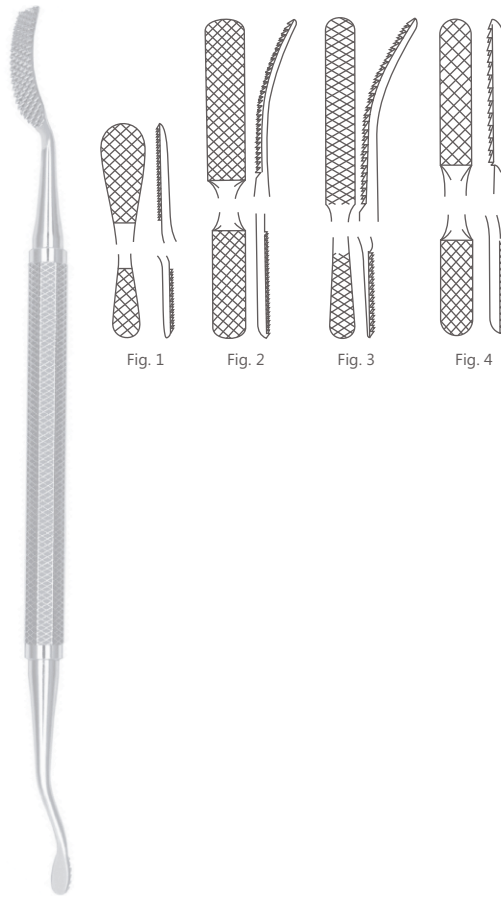

Miller-Colburn Bone File
Cross Cut

Catalog #	Size, Profile
PRO-25-703-01	18 cm (7"), Fig. 1
PRO-25-703-02	18 cm (7"), Fig. 2
PRO-25-703-03	18 cm (7"), Fig. 3
PRO-25-703-04	18 cm (7"), Fig. 4

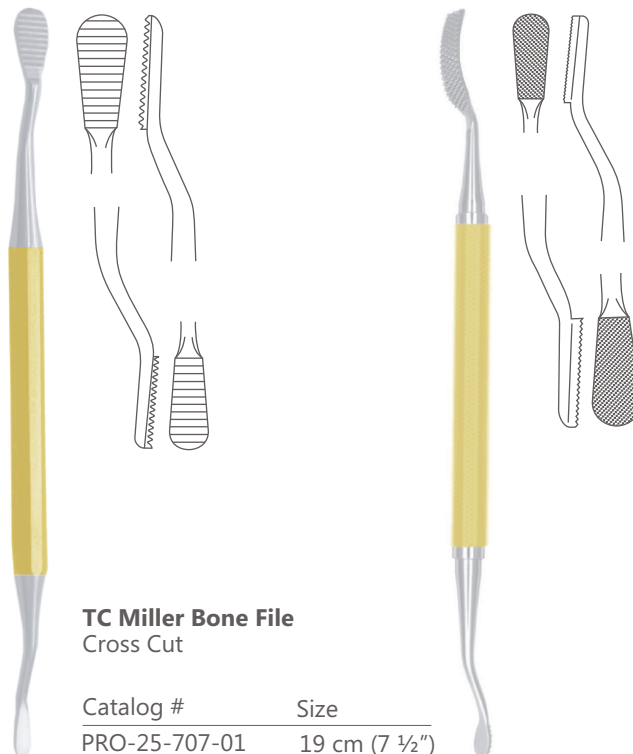

TC Miller Bone File
Drawing Cut

Catalog #	Size
PRO-25-705-01	19 cm (7 1/2")

TC Miller Bone File
Cross Cut

Catalog #	Size
PRO-25-707-01	19 cm (7 1/2")



Maltz Nasal Rasp

Catalog #	Size, Cutting Edge, Profile
PRO-25-712-01	17 cm (6 3/4"), 34 x 7 mm, Drawing Cut
PRO-25-712-02	17 cm (6 3/4"), 34 x 7 mm, Pushing Cut

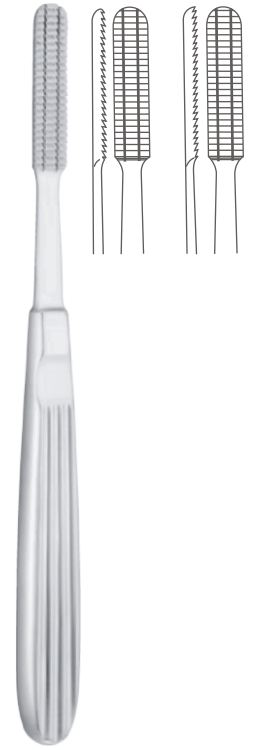

Maltz Nasal Rasp
Drawing Cut

Catalog #	Size, Cutting Edge
PRO-25-710-18	17.5 cm (7"), 40 x 9 mm

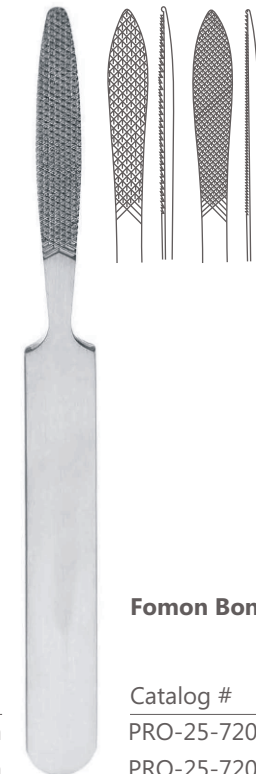

Joseph Bone File

Catalog #	Size, Cutting Edge
PRO-25-714-01	16 cm (6 1/4"), 60 x 8 mm
PRO-25-714-02	16 cm (6 1/4"), 45 x 9 mm



Fomon Bone File

Catalog #	Size, Cutting Edge
PRO-25-720-01	21 cm (8 1/4"), 30 x 8 mm
PRO-25-720-02	21 cm (8 1/4"), 30 x 8 mm



Parkes Bone File
Drawing Cut

Catalog #	Size, Cutting Edge
PRO-25-722-01	19.5 cm (7 3/4"), 35 x 8 mm
PRO-25-722-02	19.5 cm (7 3/4"), 35 x 10 mm

Gallaher Antrum Rasp

Catalog #	Size, Cutting Edge
PRO-25-724-01	17 cm (6 3/4"), 45 x 6 mm
PRO-25-724-02	17 cm (6 3/4"), 45 x 6 mm
PRO-25-724-03	17 cm (6 3/4"), 45 x 6 mm



Cottle Nasal Rasp

Catalog #	Size, Cutting Edge
PRO-25-726-21	20.5 cm (8"), 30 x 8 mm

Aufricht Glabella Rasp

Catalog #	Size, Cutting Edge, Profile
PRO-25-729-01	21 cm (8 1/4"), 32 x 9 mm, Pushing Cut
PRO-25-729-02	21 cm (8 1/4"), 32 x 9 mm, Drawing Cut

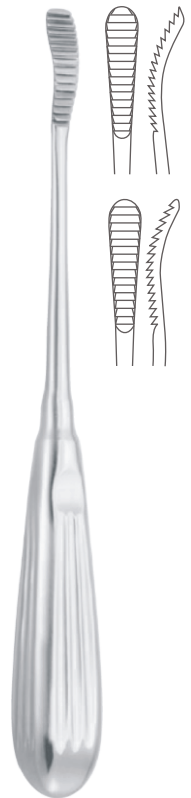



Lewis Nasal Rasp
Drawing Cut

Catalog #	Size, Cutting Edge
PRO-25-732-01	19 cm (7 ½"), 15 x 8 mm
PRO-25-732-02	19 cm (7 ½"), 15 x 8 mm



Wiener Nasal Rasp

Catalog #	Size
PRO-25-735-18	18 cm (7")



Bone File
Straight

Catalog #	Size
PRO-25-738-19	19 cm (7 ½")



Bone File
Curved

Catalog #	Size
PRO-25-739-19	19 cm (7 ½")

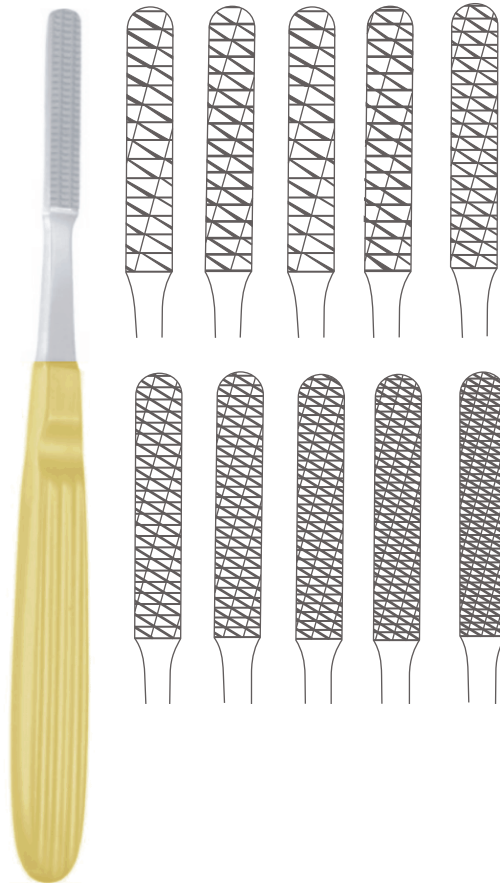

TC Maltz Nasal Rasp

Catalog #	Size
PRO-25-742-01	19.5 cm (7 3/4")
PRO-25-742-02	19.5 cm (7 3/4")
PRO-25-742-03	19.5 cm (7 3/4")
PRO-25-742-04	19.5 cm (7 3/4")
PRO-25-742-05	19.5 cm (7 3/4")
PRO-25-742-06	19.5 cm (7 3/4")
PRO-25-742-07	19.5 cm (7 3/4")
PRO-25-742-08	19.5 cm (7 3/4")
PRO-25-742-09	19.5 cm (7 3/4")
PRO-25-742-10	19.5 cm (7 3/4")

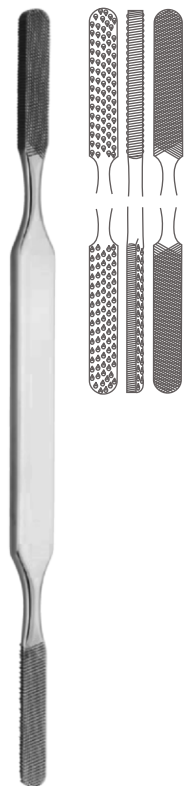

Fomon Nasal Rasp

Catalog #	Size, Cutting Edge
PRO-25-744-21	20.5 cm (8"), 30 x 8 mm

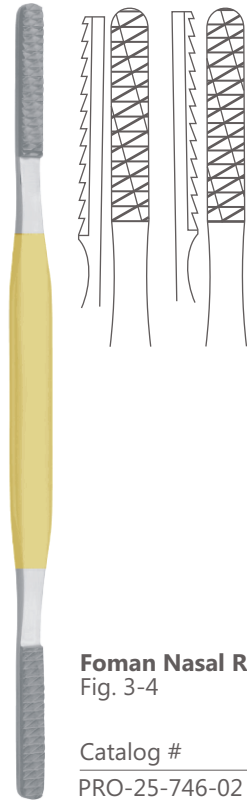

Foman Nasal Rasp
Fig. 1-2

Catalog #	Size, Cutting Edge
PRO-25-746-01	20.5 cm (8"), 30 x 8 mm

Foman Nasal Rasp
Fig. 3-4

Catalog #	Size, Cutting Edge
PRO-25-746-02	20.5 cm (8"), 40 x 7 mm

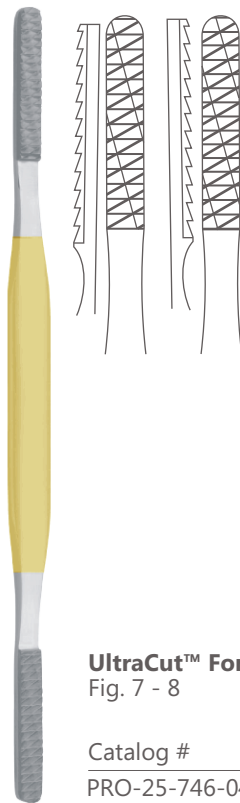
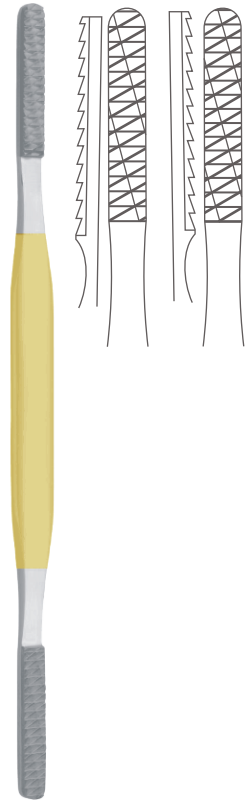

Foman Nasal Rasp
Fig. 5-6

Catalog #	Size, Cutting Edge
PRO-25-746-03	20.5 cm (8"), 40 x 7 mm

UltraCut™ Foman Nasal Rasp
Fig. 7 - 8

Catalog #	Size, Cutting Edge
PRO-25-746-04	20.5 cm (8"), 40 x 7 mm

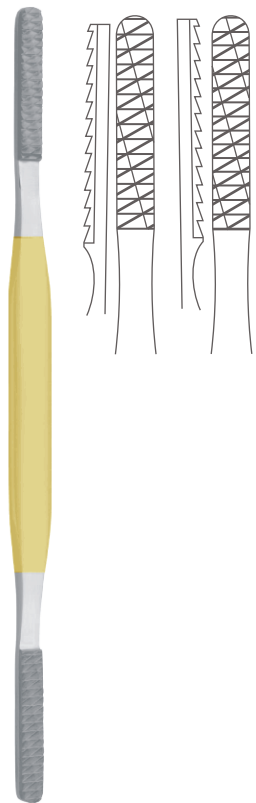

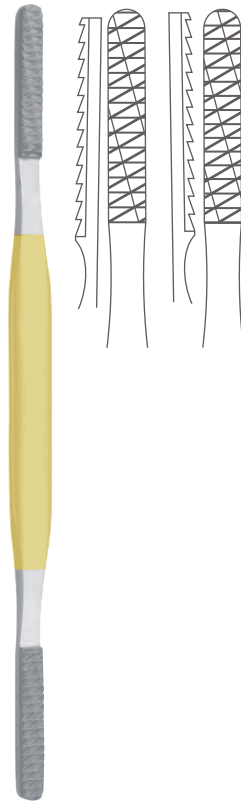

UltraCut™ Foman Nasal Rasp

Fig. 9 - 10

Catalog #	Size, Cutting Edge
PRO-25-746-05	20.5 cm (8"), 40 x 7 mm



Lange Alar Hook
Button End

Catalog #	Size
PRO-25-761-22	23 cm (9")



Fomon Alar Hook
Button End

Catalog #	Size
PRO-25-763-17	17 cm (6 3/4")

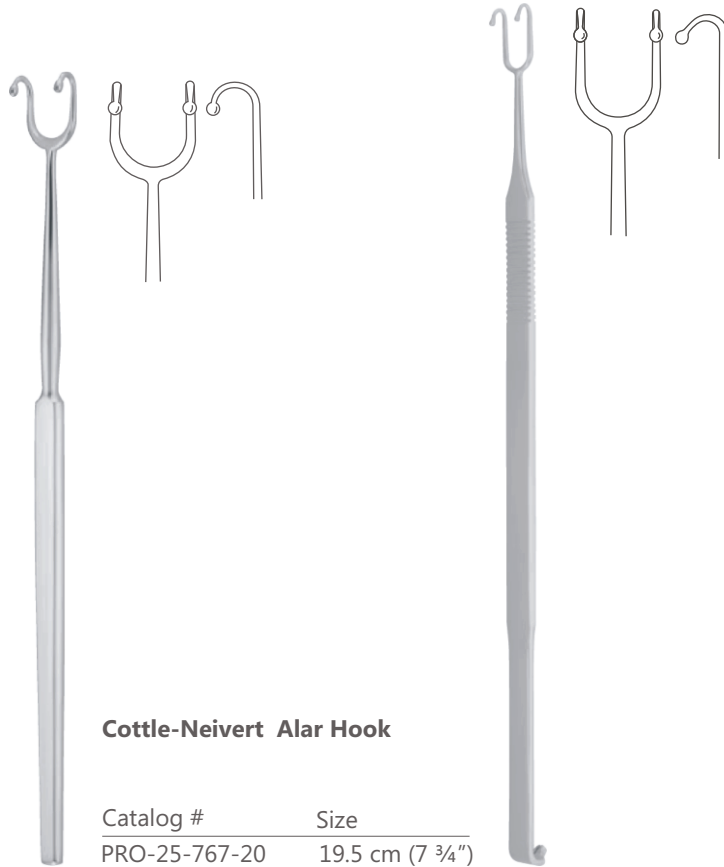

Fomon Alar Hook
Button Ended

Catalog #	Size
PRO-25-765-16	16 cm (6 1/4")

Cottle-Neivert Alar Hook

Catalog #	Size
PRO-25-767-20	19.5 cm (7 3/4")

Cottle Alar Hook

Catalog #	Size
PRO-25-771-01	14.5 cm (5 3/4"), Sharp
PRO-25-771-02	14.5 cm (5 3/4"), Blunt, Sharp
PRO-25-771-03	14.5 cm (5 3/4"), Sharp, Blunt

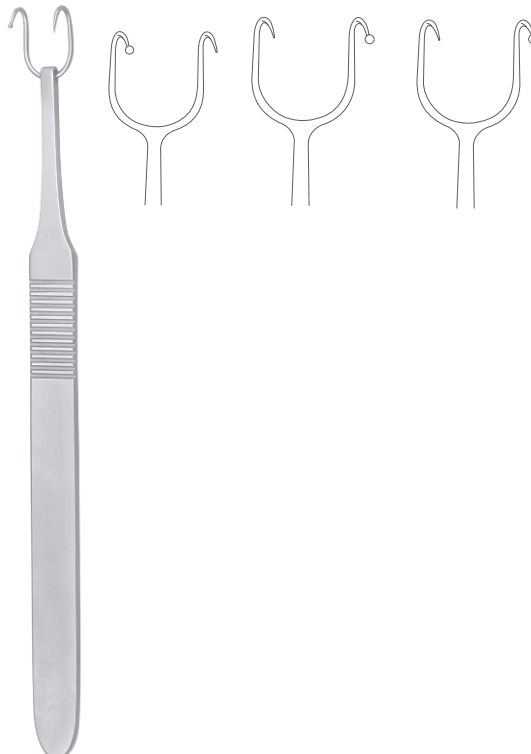



Converse Nasal Retractor

Catalog #	Size, Blade Size
PRO-25-781-01	9 cm (3 1/2"), 18 x 9.5 mm
PRO-25-781-02	9 cm (3 1/2"), 28 x 12.5 mm
PRO-25-781-03	9 cm (3 1/2"), 41 x 13.5 mm
PRO-25-781-04	9 cm (3 1/2"), 53 x 13.5 mm

Aufricht Nasal Retractor

Catalog #	Size, Blade Size
PRO-25-785-19	19 cm (7 1/2"), 40 x 12 mm

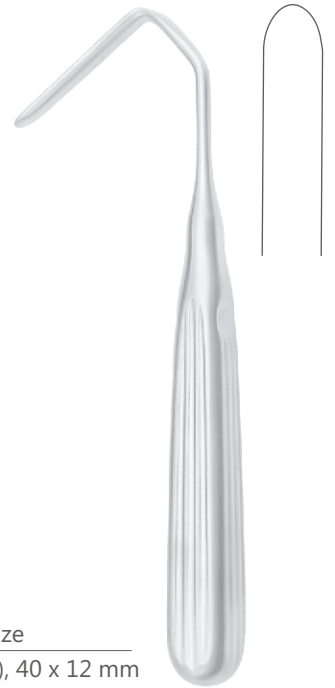

Converse Nasal Retractor

Catalog #	Size, Blade Size
PRO-25-787-11	10.5 cm (4"), 44 x 11 mm



Neivert Nasal Retractor

Catalog #	Size
PRO-25-789-16	17 cm (6 3/4")

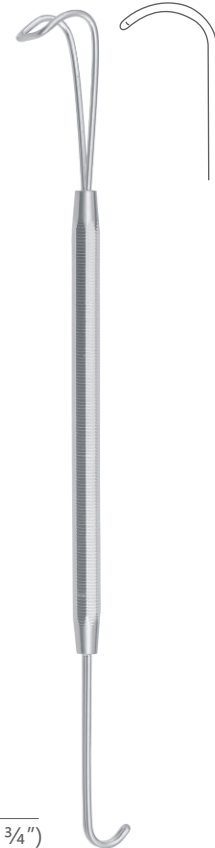



Cottle Alar Retractor

Catalog #	Size
PRO-25-791-15	16 cm (6 ¼")



**Aufricht Nasal Retractor
Blunt**

Catalog #	Size, Blade Size
PRO-25-793-14	12 cm (4 ¾"), 60 x 6.5 mm



Kressner Septum Forcep

Catalog #	Size
PRO-25-801-20	21 cm (8 ¼")

Cottle-Walsham Septum Straightning Forcep

Catalog #	Size, Profile
PRO-25-804-01	23 cm (9"), Straight
PRO-25-804-02	23 cm (9"), Left
PRO-25-804-03	23 cm (9"), Right





Asch Septum Straightning Forcep

Catalog #	Size
PRO-25-807-23	22.5 cm (8 ¾")

Aiach Columella Suturing Forcep

Catalog #	Size, Width
PRO-25-811-15	15.5 cm (6"), 5.0 mm



Ogura Sking Grasping Forcep

Catalog #	Size, Width
PRO-25-814-11	11 cm (4 ¼"), 4.0 mm

Cottle Sking Grasping Forcep

Catalog #	Size, Width
PRO-25-817-14	14 cm (5 ½"), 1.7 mm



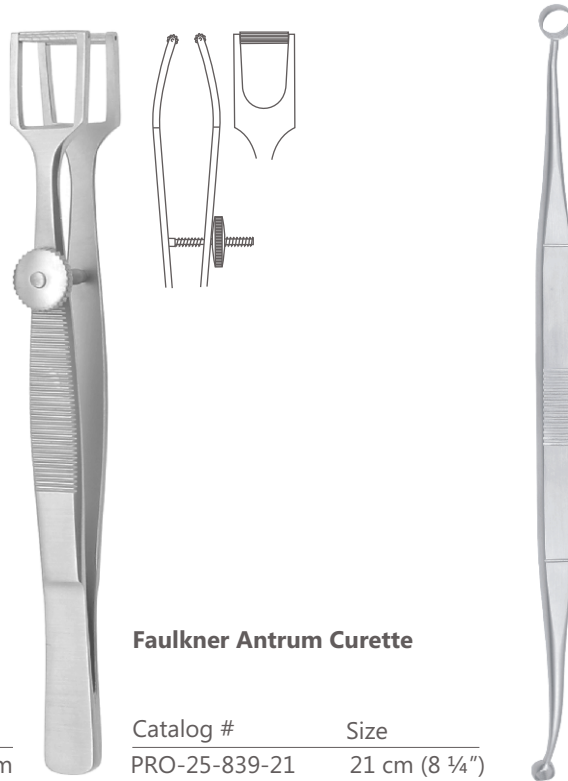

Cottle Columella Forcep

Catalog #	Size, Width
PRO-25-820-11	11 cm (4 1/4"), 12.0 mm

Faulkner Antrum Curette

Catalog #	Size
PRO-25-839-21	21 cm (8 1/4")



Coakley Antrum Curette

Catalog #	Size
PRO-25-841-01	17 cm (6 3/4")
PRO-25-841-02	17 cm (6 3/4")
PRO-25-841-03	17 cm (6 3/4")
PRO-25-841-04	17 cm (6 3/4")
PRO-25-841-05	17 cm (6 3/4")
PRO-25-841-06	17 cm (6 3/4")

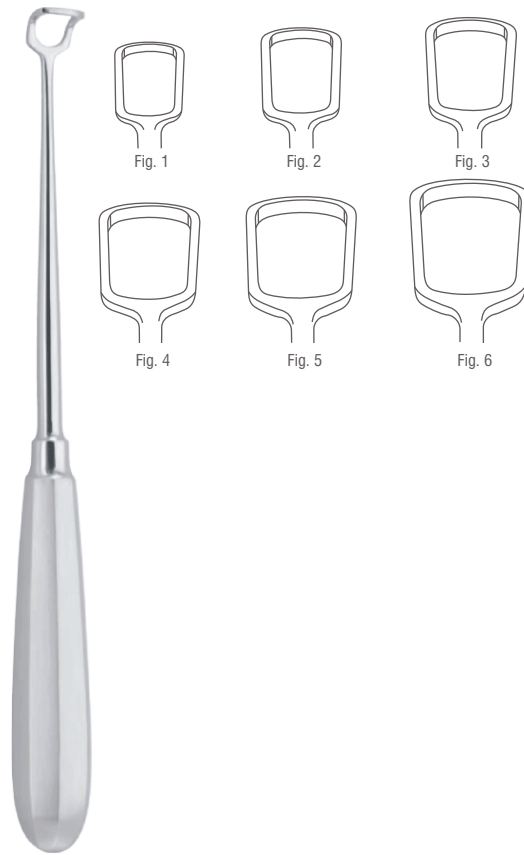

Beckmann Adenoid Curette

Catalog #	Size, Width , Profile
PRO-25-851-01	22.5 cm (8 3/4"), 13.0 mm, Fig. 1
PRO-25-851-02	22.5 cm (8 3/4"), 15.0 mm, Fig. 2
PRO-25-851-03	22.5 cm (8 3/4"), 17.0 mm, Fig. 3
PRO-25-851-04	22.5 cm (8 3/4"), 19.0 mm, Fig. 4
PRO-25-851-05	22.5 cm (8 3/4"), 21.0 mm, Fig. 5
PRO-25-851-06	22.5 cm (8 3/4"), 23.0 mm, Fig. 6

**Beckmann Adenoid Curette
Angled Shaft**

Catalog #	Size, Width, Profile
PRO-25-853-01	22 cm (8 3/4"), 13.0 mm, Fig. 1
PRO-25-853-02	22 cm (8 3/4"), 15.0 mm, Fig. 2
PRO-25-853-03	22 cm (8 3/4"), 17.0 mm, Fig. 3
PRO-25-853-04	22 cm (8 3/4"), 19.0 mm, Fig. 4
PRO-25-853-05	22 cm (8 3/4"), 21.0 mm, Fig. 5
PRO-25-853-06	22 cm (8 3/4"), 23.0 mm, Fig. 6



Barnhill Adenoid Curette

Catalog #	Size, Profile
PRO-25-855-01	22 cm (8 3/4"), Fig. 1
PRO-25-855-02	22 cm (8 3/4"), Fig. 2
PRO-25-855-03	22 cm (8 3/4"), Fig. 3
PRO-25-855-04	22 cm (8 3/4"), Fig. 4



St. Clair Thompson Adenoid Curette

Catalog #	Size, Profile
PRO-25-857-01	21 cm (8 1/4"), Fig. 1
PRO-25-857-02	21 cm (8 1/4"), Fig. 2
PRO-25-857-03	21 cm (8 1/4"), Fig. 3
PRO-25-857-04	21 cm (8 1/4"), Fig. 4



**LaForce Adenotome
With Non-Perforated Blade**

Catalog #	Size, Profile
PRO-25-861-01	25 cm (9 3/4"), Fig. 1
PRO-25-861-02	25 cm (9 3/4"), Fig. 2
PRO-25-861-03	25 cm (9 3/4"), Fig. 3



**LaForce Blade
Non-Perforated**

Catalog #	Size
PRO-25-861-11	Standard
PRO-25-861-12	Standard
PRO-25-861-13	Standard



**LaForce Adenotome
With Perforated Blade**

Catalog #	Size, Profile
PRO-25-863-01	25 cm (9 3/4"), Fig. 1
PRO-25-863-02	25 cm (9 3/4"), Fig. 2
PRO-25-863-03	25 cm (9 3/4"), Fig. 3



LaForce Blade
Perforated

Catalog #	Size
PRO-25-863-11	Standard
PRO-25-863-12	Standard
PRO-25-863-13	Standard



Eicken-Killian Irrigation

Catalog #	Size, Diameter
PRO-25-881-14	14 cm (5 ½"), Ø 3.0 mm



Ritter-Halle Frontal Sinus Dilator

Catalog #	Size, Diameter
PRO-25-891-25	14.5 cm (5 ¾"), Ø 2.5 mm
PRO-25-891-30	14.5 cm (5 ¾"), Ø 3.0 mm
PRO-25-891-40	14.5 cm (5 ¾"), Ø 4.0 mm





PRECISION[™]
SURGICAL WORKS

TONSILLECTOMY, LARYNGO-BRONCHOSCOPY

Tonsillektomie, Laryngo-Bronchoskopie
Tonsilectomia, Laringo-Bronchoscopia
Tonsillektomie, Laryngo-Bronchoskopie
Tonsilectomia, Laringo-Bronchoscopia





Fisher Tonsil / Dissector

Catalog #	Size
PRO-24-011-21	21.5 cm (8 ½")

Abraham Tonsil Knife

Catalog #	Size
PRO-24-015-19	19 cm (7 ½")

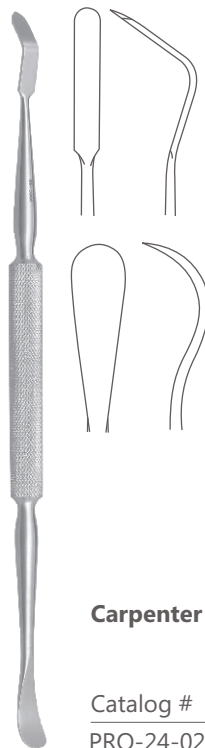

Carpenter Tonsil Knife

Catalog #	Size, Blade Width
PRO-24-021-25	25 cm (9 ¾"), 4.4 mm, 8.8 mm

Carpenter Tonsil Dissector

Catalog #	Size
PRO-24-027-24	24 cm (9 ½")





Hurd Tonsil Dissector / Retractor

Catalog #	Size, Blade Width
PRO-24-031-22	22.5 cm (8 ¾"), 11.0, 14.0 mm

Henke Tonsil Elevator

Catalog #	Size, Blade Width
PRO-24-037-23	22.5 cm (8 ¾"), 10.0, 5.0 mm

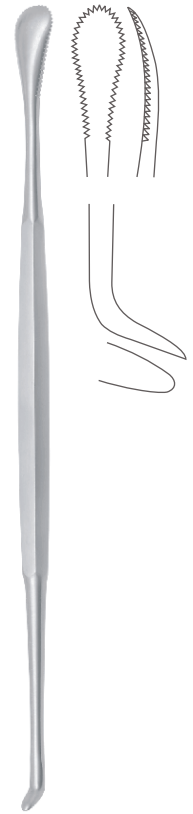

Henke Tonsil Elevator

Catalog #	Size, Blade Width
PRO-24-039-23	22.5 cm (8 ¾"), 16.0, 5.0 mm

Gwynne-Evan Tonsil Elevator

Catalog #	Size
PRO-24-043-22	20 cm (8")





Love Tonsil Retractor

Catalog #	Size, Blade Width
PRO-24-051-18	20 cm (8"), 18 mm
PRO-24-051-20	23 cm (9"), 20 mm
PRO-24-051-22	23 cm (9"), 22 mm

Nager Tonsil Retractor

Catalog #	Size
PRO-24-055-23	23 cm (9")



Hofer Tonsil Retractor

Catalog #	Size
PRO-24-059-24	24 cm (9 1/2")

Haslinger Tonsil Retractor

Catalog #	Size
PRO-24-063-17	17 cm (6 3/4")





Roeder Tonsil Ligator

Catalog #	Size
PRO-24-065-00	26.5 cm (10 1/2")

Luniatschek Gauze Packer

Catalog #	Size, Width
PRO-24-073-19	17.5 cm (7"), 3 mm
PRO-24-073-20	17.5 cm (7"), 2 mm

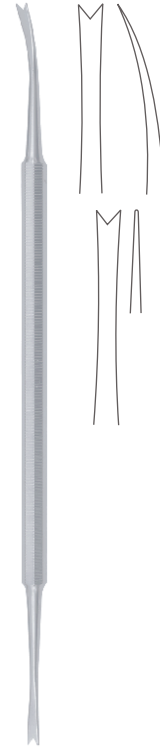

White Tonsil Grasping Forcep

Catalog #	Size
PRO-24-101-18	18 cm (7")

**Blohmke Tonsil Grasping Forcep
1 x 2 Teeth**

Catalog #	Size
PRO-24-105-20	20 cm (8")



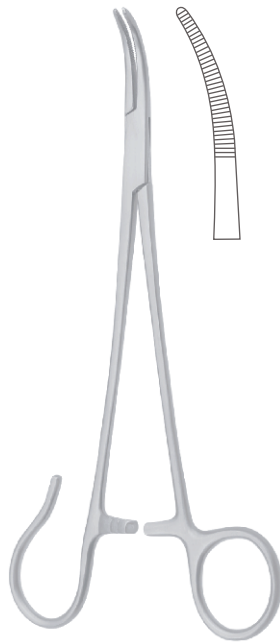

Schnidt Tonsil Forcep

Catalog #	Size
PRO-24-111-19	19 cm (7 ½")

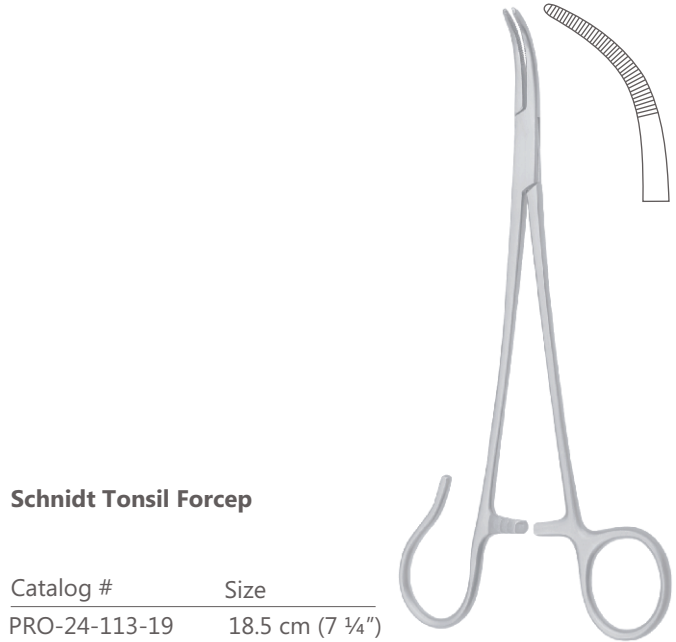

Schnidt Tonsil Forcep

Catalog #	Size
PRO-24-113-19	18.5 cm (7 ¼")

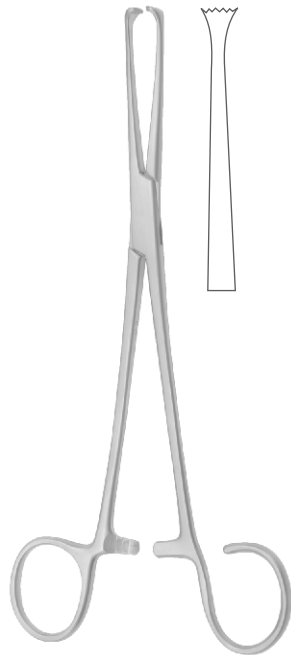

Colver Tonsil Grasping Forcep
Straight

Catalog #	Size
PRO-24-116-19	19 cm (7 ½")

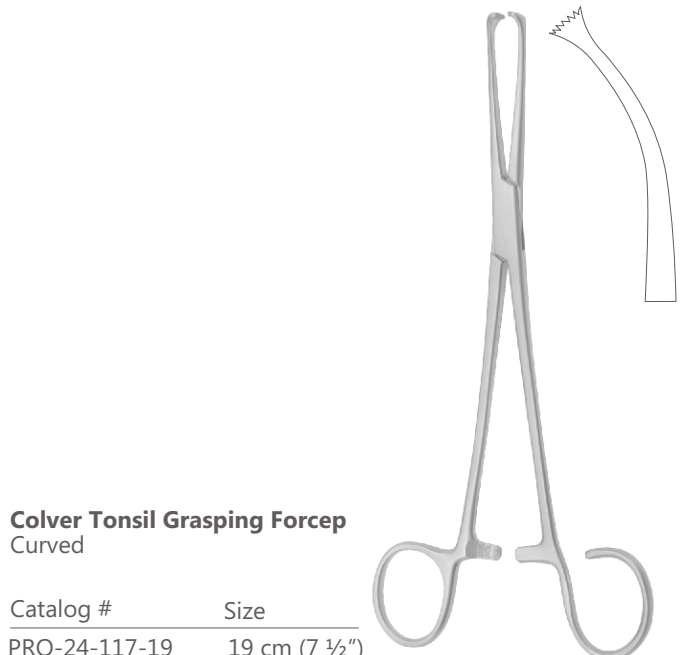

Colver Tonsil Grasping Forcep
Curved

Catalog #	Size
PRO-24-117-19	19 cm (7 ½")



Museux Tonsil Grasping Forcep
Curved

Catalog #	Size
PRO-24-120-20	20 cm (8")



Eves Tonsil Snare
Without Ratchet

Catalog #	Size
PRO-24-150-28	28.5 cm (11 ¼")



Eves Tonsil Snare
With Ratchet

Catalog #	Size
PRO-24-152-28	28.5 cm (11 ¼")



Bruenings Tonsil Snare
With Double Ratchet

Catalog #	Size
PRO-24-156-29	29 cm (11 ½")

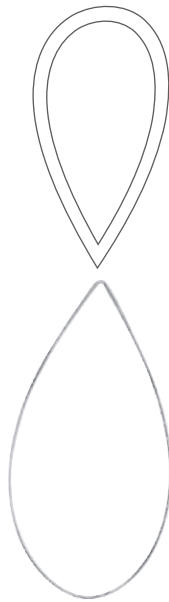

Wire Loop for Tonsil Snare

Pack of 100

Catalog #	Size, Loop Diameter
PRO-24-161-40	Ø 40.0 mm
PRO-24-161-50	Ø 50.0 mm

Snare Wire
Pack of 100

Catalog #	Size, Wire Diameter
PRO-24-163-00	Ø 0.3 mm

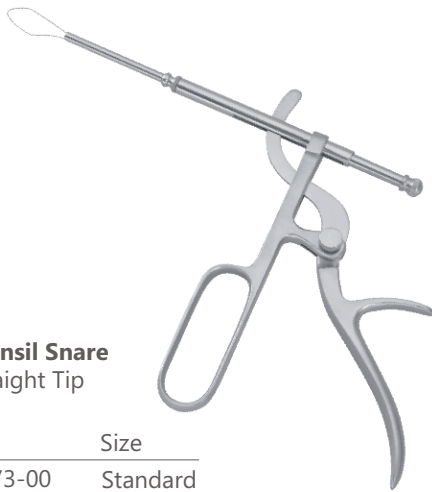

Tyding Tonsil Snare
With 1 Straight Tip

Catalog #	Size
PRO-24-173-00	Standard



Sluder-Ballenger Tonsillectome Completer
With 3 Tip

Catalog #	Size
PRO-24-181-00	Standard



Sluder-Ballenger Tonsillectome Handle Only

Catalog #	Size
PRO-24-181-01	Standard

Sluder-Ballenger Tonsillectome Tip

Catalog #	Size, Profile
PRO-24-183-01	Standard, Fig. 1
PRO-24-183-02	Standard, Fig. 2
PRO-24-183-03	Standard, Fig. 3

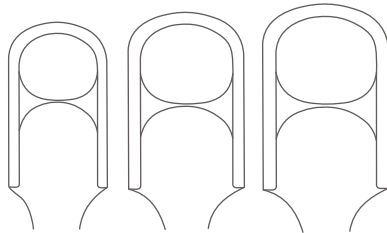

Corwin Tonsil Hemostat

Catalog #	Size
PRO-24-191-14	14 cm (5 1/2")

Hartmann Tonsil Punch Through Cutting

Catalog #	Size, Diameter
PRO-24-201-13	12 cm (4 3/4"), Ø 13.0 mm
PRO-24-201-15	12 cm (4 3/4"), Ø 15.0 mm
PRO-24-201-17	12 cm (4 3/4"), Ø 17.0 mm



Schmeden Tonsil Punch
Through Cutting

Catalog #	Size
PRO-24-213-01	12 cm (4 ¾")
PRO-24-213-02	12 cm (4 ¾")
PRO-24-213-03	12 cm (4 ¾")



Huber Universal Handle

Catalog #	Size
PRO-24-301-01	Standard

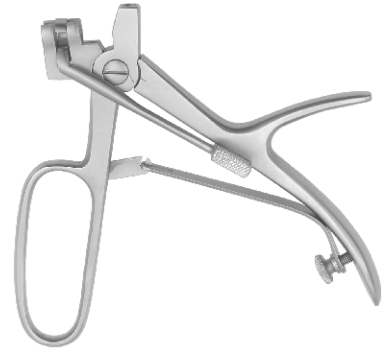

Bruenings Interchangeable Tube
Straight

Catalog #	Size
PRO-24-302-20	20 cm (8")
PRO-24-302-30	30 cm (12")
PRO-24-302-40	40 cm (16")



Bruenings Interchangeable Tube
Curved

Catalog #	Size
PRO-24-303-20	20 cm (8")



Fraenkel Broncho-Esophagoscopy Forcep Tip



Catalog #	Size
PRO-24-310-01	Standard

Seiffert Broncho-Esophagoscopy Forcep Tip

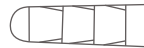

Catalog #	Size
PRO-24-314-01	Standard

Fraenkel Broncho-Esophagoscopy Forcep Tip



Catalog #	Size
PRO-24-318-01	Standard

Scheinmann Broncho-Esophagoscopy Forcep Tip



Catalog #	Size
PRO-24-321-01	Standard

Scheinmann Broncho-Esophagoscopy Forcep Tip



Catalog #	Size
PRO-24-323-01	Standard

Bruenings Broncho-Esophagoscopy Forcep Tip

Catalog #	Size
PRO-24-326-02	Standard
PRO-24-326-03	Standard

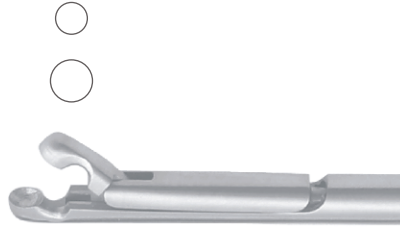

Bruenings Broncho-Esophagoscopy Forcep Tip

Catalog #	Size
PRO-24-328-02	Standard
PRO-24-328-03	Standard



Lange Broncho-Esophagoscopy Forcep Tip

Catalog #	Size
PRO-24-334-01	Standard



Krause Broncho-Esophagoscopy Forcep Tip

Catalog #	Size
PRO-24-338-01	Standard
PRO-24-338-02	Standard

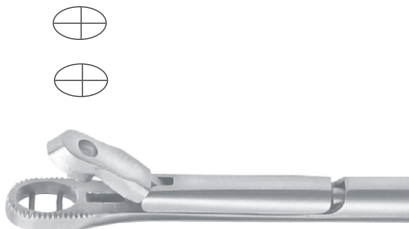

Krause Broncho-Esophagoscopy Forcep Tip

Catalog #	Size
PRO-24-342-01	Standard



Cordes Broncho-Esophagoscopy Forcep Tip

Catalog #	Size
PRO-24-347-01	Standard
PRO-24-347-02	Standard
PRO-24-347-03	Standard
PRO-24-347-04	Standard



Schumacher Broncho-Esophagoscopy Forcep Tip

Catalog #	Size
PRO-24-349-01	Standard



Cordes Broncho-Esophagoscopy Forcep Tip

Catalog #	Size
PRO-24-353-01	Standard
PRO-24-353-02	Standard



Cordes Broncho-Esophagoscopy Forcep Tip

Catalog #	Size
PRO-24-357-01	Standard



Rosenberg Broncho-Esophagoscopy Forcep Tip

Catalog #	Size
PRO-24-367-01	Standard



Chevalier-Jackson Square Punch

Catalog #	Size
PRO-24-381-30	30 cm (12")
PRO-24-381-40	40 cm (15 ¾")
PRO-24-381-50	50 cm (19 ½")
PRO-24-381-60	60 cm (23 ½")



Chevalier-Jackson Grasping Forcep

Catalog #	Size
PRO-24-383-30	30 cm (12")
PRO-24-383-40	40 cm (15 ¾")
PRO-24-383-50	50 cm (19 ½")
PRO-24-383-60	60 cm (23 ½")



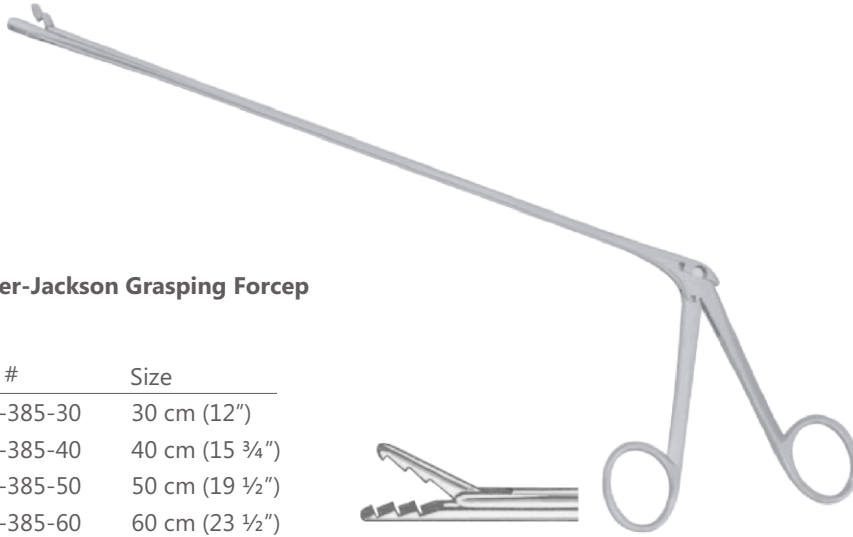

Chevalier-Jackson Grasping Forcep

Catalog #	Size
PRO-24-385-30	30 cm (12")
PRO-24-385-40	40 cm (15 3/4")
PRO-24-385-50	50 cm (19 1/2")
PRO-24-385-60	60 cm (23 1/2")

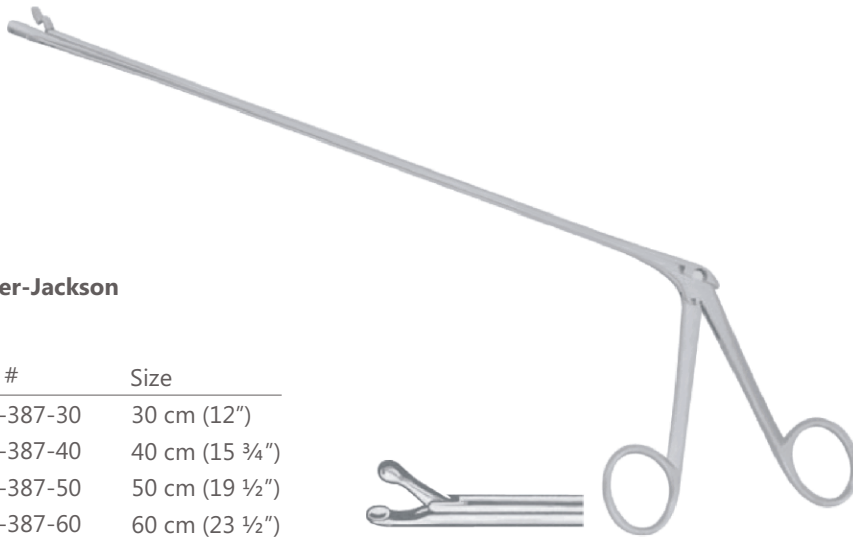

**Chevalier-Jackson
Straight**

Catalog #	Size
PRO-24-387-30	30 cm (12")
PRO-24-387-40	40 cm (15 3/4")
PRO-24-387-50	50 cm (19 1/2")
PRO-24-387-60	60 cm (23 1/2")

Chevalier-Jackson Basket Punch

Catalog #	Size
PRO-24-389-30	30 cm (12")
PRO-24-389-40	40 cm (15 3/4")
PRO-24-389-50	50 cm (19 1/2")
PRO-24-389-60	60 cm (23 1/2")



Chevalier-Jackson Oval Biopsy Forcep

Catalog #	Size
PRO-24-391-30	30 cm (12")
PRO-24-391-40	40 cm (15 3/4")
PRO-24-391-50	50 cm (19 1/2")
PRO-24-391-60	60 cm (23 1/2")



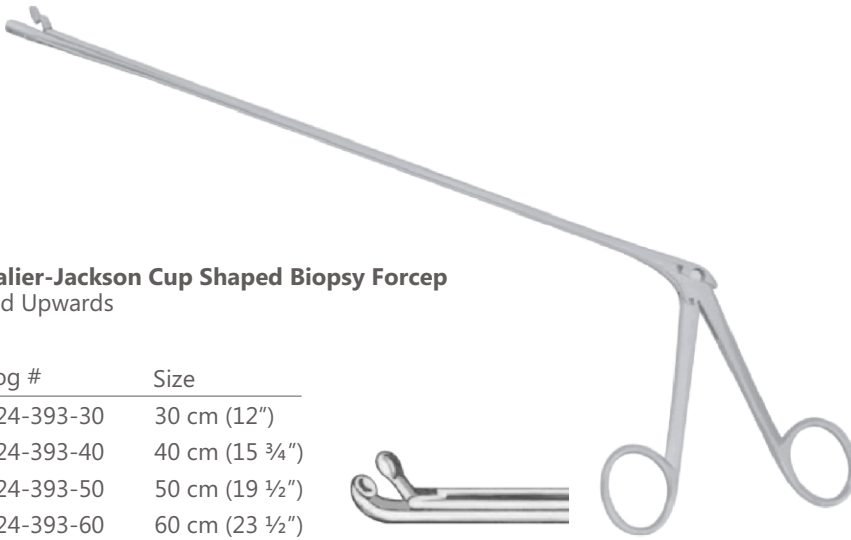

Chevalier-Jackson Cup Shaped Biopsy Forcep
Curved Upwards

Catalog #	Size
PRO-24-393-30	30 cm (12")
PRO-24-393-40	40 cm (15 3/4")
PRO-24-393-50	50 cm (19 1/2")
PRO-24-393-60	60 cm (23 1/2")

Laryngeal Mirror
Rhodium Plated With Fixed Handle

Catalog #	Size, Mirror Diameter, Profile
PRO-24-402-08	18.5 cm (7 1/4"), Ø 8 mm, Fig. 00
PRO-24-402-10	18.5 cm (7 1/4"), Ø 10 mm, Fig. 0
PRO-24-402-12	18.5 cm (7 1/4"), Ø 12 mm, Fig. 1
PRO-24-402-14	18.5 cm (7 1/4"), Ø 14 mm, Fig. 2
PRO-24-402-16	18.5 cm (7 1/4"), Ø 16 mm, Fig. 3
PRO-24-402-18	18.5 cm (7 1/4"), Ø 18 mm, Fig. 4
PRO-24-402-20	18.5 cm (7 1/4"), Ø 20 mm, Fig. 5
PRO-24-402-22	18.5 cm (7 1/4"), Ø 22 mm, Fig. 6
PRO-24-402-24	18.5 cm (7 1/4"), Ø 24 mm, Fig. 7
PRO-24-402-26	18.5 cm (7 1/4"), Ø 26 mm, Fig. 8
PRO-24-402-28	18.5 cm (7 1/4"), Ø 28 mm, Fig. 9
PRO-24-402-30	18.5 cm (7 1/4"), Ø 30 mm, Fig. 10



Laryngeal Mirror

Rhodium Plated Without Handle

Catalog #	Size, Mirror Diameter, Profile
PRO-24-406-08	13.5 cm (5 1/4"), Ø 8 mm, Fig. 00
PRO-24-406-10	13.5 cm (5 1/4"), Ø 10 mm, Fig. 0
PRO-24-406-12	13.5 cm (5 1/4"), Ø 12 mm, Fig. 1
PRO-24-406-14	13.5 cm (5 1/4"), Ø 14 mm, Fig. 2
PRO-24-406-16	13.5 cm (5 1/4"), Ø 16 mm, Fig. 3
PRO-24-406-18	13.5 cm (5 1/4"), Ø 18 mm, Fig. 4
PRO-24-406-20	13.5 cm (5 1/4"), Ø 20 mm, Fig. 5
PRO-24-406-22	13.5 cm (5 1/4"), Ø 22 mm, Fig. 6
PRO-24-406-24	13.5 cm (5 1/4"), Ø 24 mm, Fig. 7
PRO-24-406-26	13.5 cm (5 1/4"), Ø 26 mm, Fig. 8
PRO-24-406-28	13.5 cm (5 1/4"), Ø 28 mm, Fig. 9
PRO-24-406-30	13.5 cm (5 1/4"), Ø 30 mm, Fig. 10



Michel Laryngeal Mirror

With Handle, Moveable Mirror

Catalog #	Size, Mirror Diameter, Profile
PRO-24-413-12	25 cm (9 3/4"), Ø 12 mm, Fig. 1
PRO-24-413-14	25 cm (9 3/4"), Ø 14 mm, Fig. 2
PRO-24-413-16	25 cm (9 3/4"), Ø 16 mm, Fig. 3
PRO-24-413-18	25 cm (9 3/4"), Ø 18 mm, Fig. 4



Laryngeal Mirror Handle

Catalog #	Size
PRO-24-420-10	10 cm (4")





The Choice of Professionals