



**PRECISION**<sup>™</sup>  
SURGICAL WORKS

## ORAL MAXILLO-FACIAL SURGERY

Mund-, Kiefer- und Gesichtschirurgie

Cirugía oral y maxilofacial

Chirurgie buccale et maxillo-faciale

Chirurgia maxillo-facciale

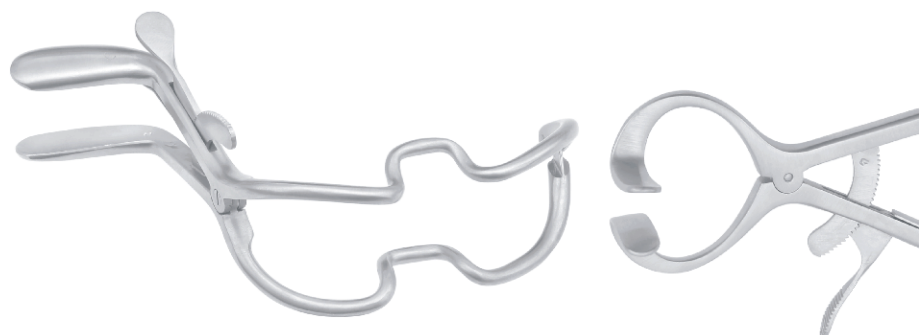

**Adams Napkin Holder**

Consisting of Chain and Two Crocodile Forceps

Catalog #	Size
PRO-22-011-01	Standard



**Langenbeck Finger Protector**

Catalog #	Diameter
PRO-22-015-01	Ø 18.0 mm
PRO-22-015-02	Ø 21.0 mm
PRO-22-015-03	Ø 22.0 mm



**Maunder Mouth Gag**  
Wood

Catalog #	Size
PRO-22-018-10	Standard



**Heister Mouth Gag**

Catalog #	Size
PRO-22-030-13	13 cm (5")



**Obwegeser Mouth Gag**

Catalog #	Size
PRO-22-032-11	11 cm (4 1/4")



**Molt Mouth Gag**

Catalog #	Size
PRO-22-035-11	11 cm (4 1/4")
PRO-22-035-14	13 cm (5")



**Denhart Mouth Gag**

Catalog #	Size, Jaw Size
PRO-22-039-12	13 cm (5"), 16 mm



**Roser-Koenig Mouth Gag**

Catalog #	Size
PRO-22-041-16	16 cm (6 1/4")
PRO-22-041-20	20 cm (8")

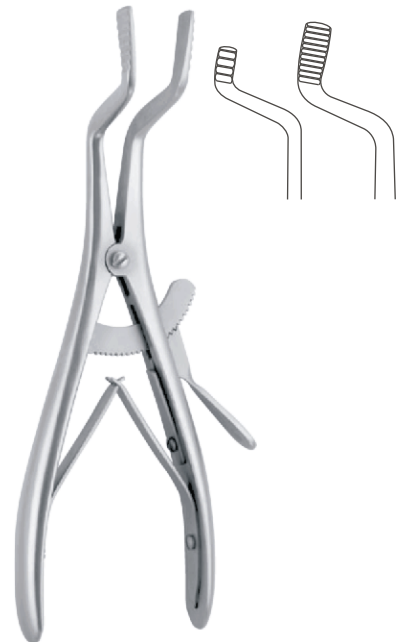



**Fergusson-Ackland Mouth Gag**

Catalog #	Size
PRO-22-043-18	14.5 cm (5 ¾")
PRO-22-043-20	18 cm (7")

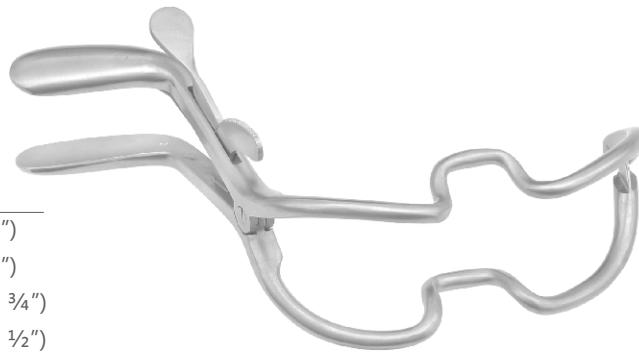

**Jennings Mouth Gag**

Catalog #	Size
PRO-22-047-09	10.5 cm (4")
PRO-22-047-11	12.5 cm (5")
PRO-22-047-13	14.5 cm (5 ¾")
PRO-22-047-15	16.5 cm (6 ½")

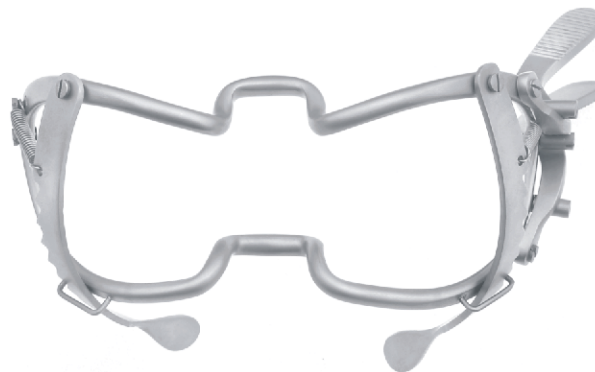

**Whitehead Mouth Gag**

Without Tongue Depressor Ratchet

Catalog #	Size
PRO-22-049-11	11 cm (4 ¼")
PRO-22-049-13	13 cm (5")
PRO-22-049-15	15 cm (6")

**Whitehead Mouth Gag**  
With Tongue Depressor Ratchet

Catalog #	Size
PRO-22-051-13	13 cm (5")

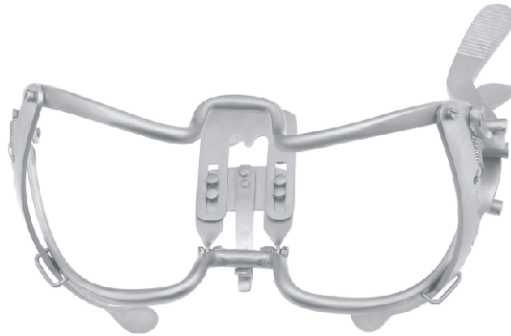

**Negus Chest Support for Mouth Gag**

Catalog #	Size
PRO-22-058-00	20 cm (8")



**Kilner-Doughty Mouth Gag Complete**  
With 3 Tongue Depressors

Catalog #	Size
PRO-22-060-00	Standard



**Kilner-Doughty Mouth Gag**  
Frame Only

Catalog #	Size
PRO-22-061-00	14.5 cm (5 3/4")



**Kilner-Doughty Tongue Depressor**  
Fenestrated Blade for Suction



Catalog #	Size, Blade Size
PRO-22-063-01	13.5 cm (5 1/4"), 70 x 29 mm
PRO-22-063-02	13.5 cm (5 1/4"), 80 x 34 mm
PRO-22-063-03	13.5 cm (5 1/4"), 85 x 38 mm

**Davis-Boyle Mouth Gag Complete**  
With 5 Tongue Depressors

Catalog #	Size
PRO-22-070-00	Standard



**Davis-Boyle Mouth Gag**  
Frame Only

Catalog #	Size
PRO-22-071-00	Standard



**Davis-Boyle Tongue Depressor**  
With Fixed Suction Tube

Catalog #	Size, Blade Size
PRO-22-073-01	13.5 cm (5 1/4"), 100 x 26 mm
PRO-22-073-02	13.5 cm (5 1/4"), 100 x 26 mm
PRO-22-073-03	13.5 cm (5 1/4"), 100 x 26 mm
PRO-22-073-04	13.5 cm (5 1/4"), 100 x 26 mm





**Davis-Boyle Tongue Depressor**  
With Suction Tube

Catalog #	Size, Blade Size
PRO-22-073-05	13.5 cm (5 ¼"), 30 x 20 mm



**McIvor Mouth Gag Complete**  
With 3 Tongue Depressors

Catalog #	Size
PRO-22-080-00	Standard



**McIvor Mouth Gag**  
Frame Only

Catalog #	Size
PRO-22-081-00	15 cm (6")



**McIvor Tongue Depressor**

Catalog #	Size, Blade Size
PRO-22-083-01	13.5 cm (5 ¼"), 100 x 26 mm
PRO-22-083-02	13.5 cm (5 ¼"), 85 x 25 mm
PRO-22-083-03	13.5 cm (5 ¼"), 75 x 23 mm

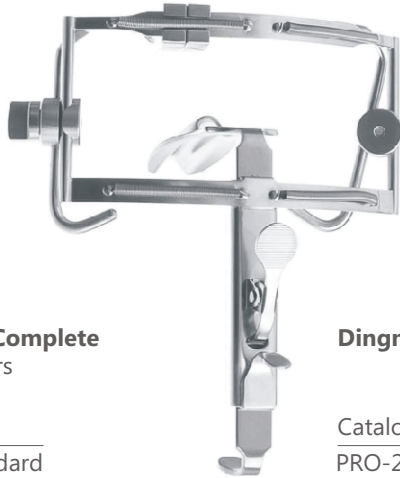

**Dingmann Mouth Gag Complete**  
With 3 Tongue Depressors

Catalog #	Size
PRO-22-090-00	Standard

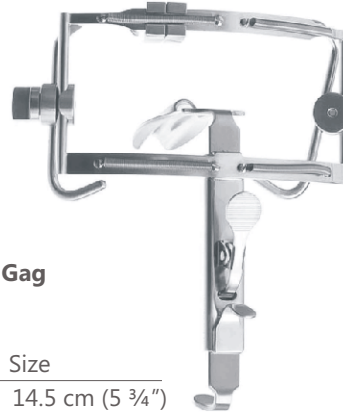

**Dingmann Mouth Gag**

Catalog #	Size
PRO-22-091-00	14.5 cm (5 ¾")



**Dingmann Tongue Depressor**

Catalog #	Size, Blade Size
PRO-22-093-01	13.5 cm (5 ¼"), 65 x 25 mm
PRO-22-093-02	13.5 cm (5 ¼"), 70 x 29 mm
PRO-22-093-03	13.5 cm (5 ¼"), 80 x 32 mm

**Negus Tongue Depressor**

Catalog #	Size, Blade Size
PRO-22-097-01	13.5 cm (5 ¼"), 70 x 20 mm
PRO-22-097-02	13.5 cm (5 ¼"), 80 x 30 mm
PRO-22-097-03	13.5 cm (5 ¼"), 95 x 35 mm





**Draffin Bipod Complete**  
With 2 Draffin Bipod Rod

Catalog #	Size
PRO-22-100-00	Standard

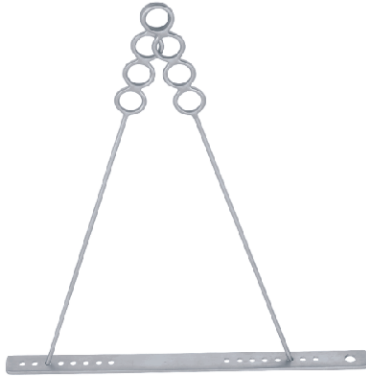

**Maguaran Plate**  
For Holding Draffin Bipod

Catalog #	Size
PRO-22-100-01	40 cm (15 3/4")

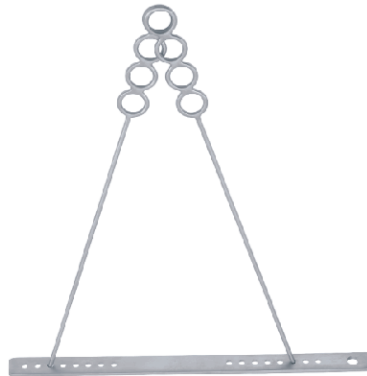

**Draffin Biopod Rod**  
With 4 Rings for Varying Height

Catalog #	Size
PRO-22-100-48	48 cm (19")

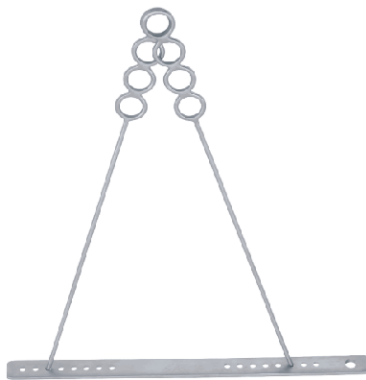

**McKesson Mouth Prop**

Catalog #	Profile
PRO-22-110-01	For Baby
PRO-22-110-02	For Child
PRO-22-110-03	For Adult
PRO-22-110-04	For Adult
PRO-22-110-05	For Edentulous

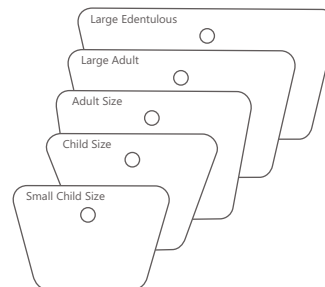
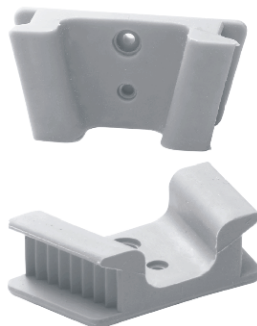



**Martin-Simplex Lip and Cheek Retractor**

Catalog #	Size
PRO-22-121-11	10 cm (4")

**Obwegeser Lip and Cheek Retractor**

Catalog #	Size
PRO-22-123-12	10 cm (4¾")

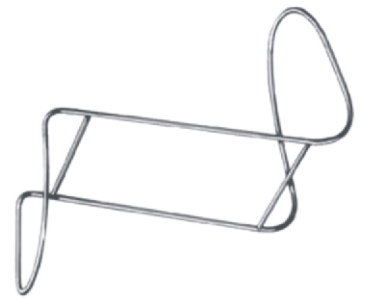

**Bishop Lip and Cheek Retractor**

Catalog #	Size, Blade Width
PRO-22-127-13	13.5 cm (5 ¼"), 27 mm

**Cawood-Minnesota Cheek Retractor**

Catalog #	Size, Blade Width
PRO-22-131-15	15 cm (6"), 20 mm





**Minnesota Cheek Retractor**

Catalog #	Size
PRO-22-135-14	14.5 cm (5 ¾")



**Hartmann Tongue Depressor**

Catalog #	Size, Blade Size
PRO-22-141-15	15 cm (6"), 72 x 23 mm



**Tobold Tongue Depressor**

Catalog #	Size, Blade Size
PRO-22-143-15	15 cm (6"), 88 x 25 mm



**Andrew Tongue Depressor**

Catalog #	Size
PRO-22-145-14	14.5 cm (5 ¾")



**Wieder Tongue Depressor**

Catalog #	Size, Blade Width
PRO-22-147-01	14 cm (5 ½"), 36 mm
PRO-22-147-02	15 cm (6"), 43 mm



**Standard Tongue Depressor**

Catalog #	Size
PRO-22-151-14	14.5 cm (5 ¾")

**Kroenig Tongue Depressor**

Catalog #	Size
PRO-22-153-15	15 cm (6")



**Mayo Tongue Depressor**

Catalog #	Size
PRO-22-155-17	17 cm (6 ¾")

**Bruenings Tongue Depressor**

Catalog #	Size, Blade Width 1 - Blade Width 2
PRO-22-159-19	19 cm (7 ½"), 19 mm - 15 mm



**Colling Tongue Holding Forcep**

Catalog #	Size, Jaw Size
PRO-22-170-17	17 cm (6 ¾"), 24 x 27 mm





**Young Tongue Holding Forcep**

Catalog #	Size
PRO-22-173-17	15 cm (6")

**Henahan Retractor**

Catalog #	Size, Profile
PRO-22-201-01	18 cm (7"), Fig. 1
PRO-22-201-02	18 cm (7"), Fig. 2
PRO-22-201-03	18 cm (7"), Fig. 3

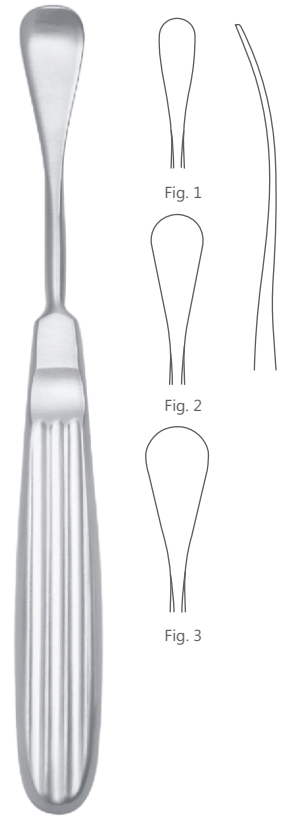

**Sigmoid Notch Extra Oral Retractor**  
Concave Blade Full Bent Tip

Catalog #	Size, Blade Size
PRO-22-251-24	22 cm (8 3/4"), 9.5 mm x 16 mm



**Petri Intra Oral Retractor**  
For LeFort Osteotomies

Catalog #	Size, Blade Width
PRO-22-255-24	23 cm (9"), 25.5 mm





**Bauer Intra Oral Retractor**  
Left

Catalog #	Size
PRO-22-259-21	21 cm (8 ¼")



**Bauer Intra Oral Retractor**  
Right

Catalog #	Size
PRO-22-261-21	21 cm (8 ¼")



**Levasseur-Merrill Intra Oral Retractor**

Catalog #	Size
PRO-22-265-25	25 cm (9 ¾")

**Obwegeser Soft Tissue Retractor**  
Bent Upwards

Catalog #	Size, Blade Size
PRO-22-271-16	24 cm (9 ½"), 5 x 16 mm
PRO-22-271-25	24 cm (9 ½"), 7 x 25 mm
PRO-22-271-35	24 cm (9 ½"), 10 x 35 mm
PRO-22-271-42	24 cm (9 ½"), 10 x 42 mm
PRO-22-271-55	24 cm (9 ½"), 12 x 55 mm
PRO-22-271-70	24 cm (9 ½"), 14 x 70 mm
PRO-22-271-80	24 cm (9 ½"), 16 x 80 mm

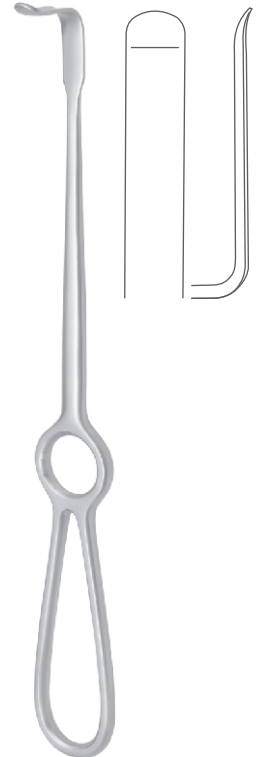

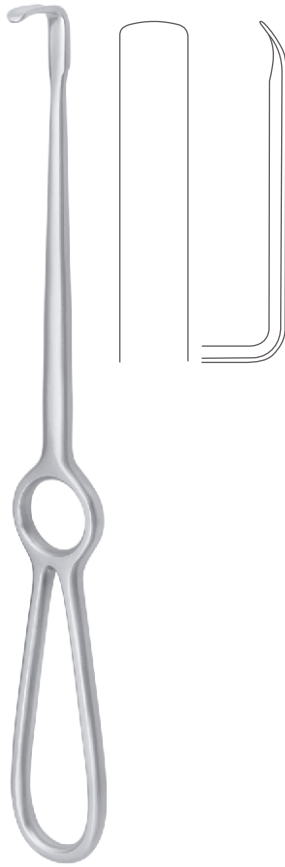

**Obwegeser Soft Tissue Retractor**  
Bent Downwards

Catalog #	Size, Blade Size
PRO-22-273-16	24 cm (9 ½"), 5 x 16 mm
PRO-22-273-25	24 cm (9 ½"), 7 x 25 mm
PRO-22-273-35	24 cm (9 ½"), 10 x 35 mm
PRO-22-273-42	24 cm (9 ½"), 10 x 42 mm
PRO-22-273-55	24 cm (9 ½"), 12 x 55 mm
PRO-22-273-70	24 cm (9 ½"), 14 x 70 mm
PRO-22-273-80	24 cm (9 ½"), 16 x 80 mm

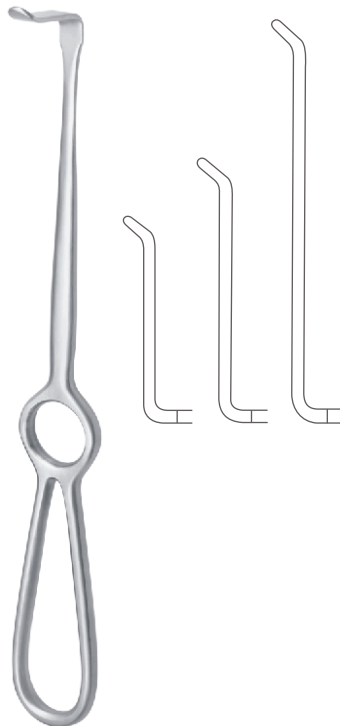

**Obwegeser Soft Tissue Retractor**  
Bent Upwards

Catalog #	Size, Blade Size
PRO-22-275-43	21.5 cm (8 ½"), 11 x 43 mm
PRO-22-275-57	21.5 cm (8 ½"), 11 x 57 mm
PRO-22-275-83	21.5 cm (8 ½"), 16 x 83 mm



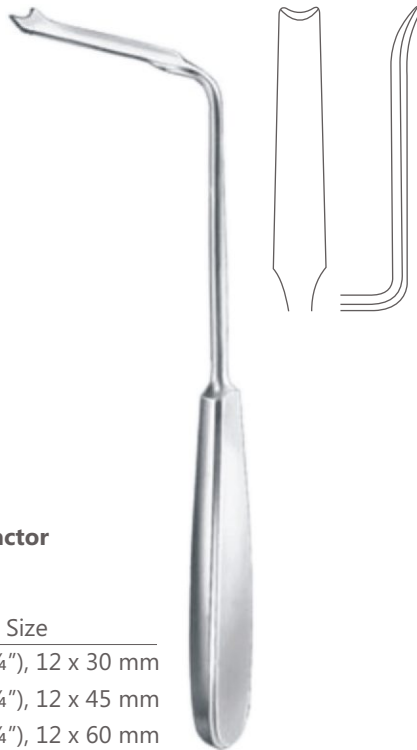

**Obwegeser Mandibular Retractor**

Catalog #	Size, Blade Size
PRO-22-279-30	21 cm (8 ¼"), 12 x 30 mm
PRO-22-279-45	21 cm (8 ¼"), 12 x 45 mm
PRO-22-279-60	21 cm (8 ¼"), 12 x 60 mm

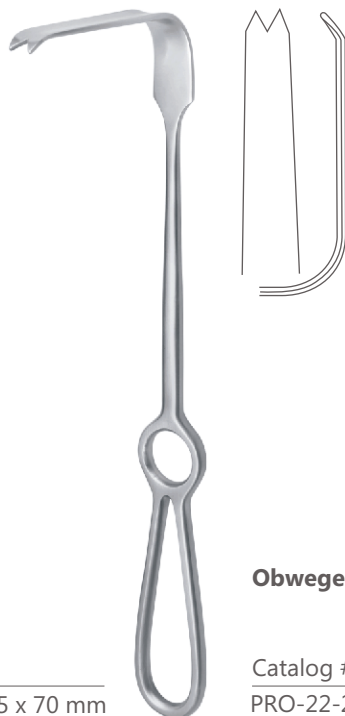

**Obwegeser Ramus Retractor**

Catalog #	Size, Blade Size
PRO-22-281-22	24.5 cm (9 ¾"), 15 x 70 mm

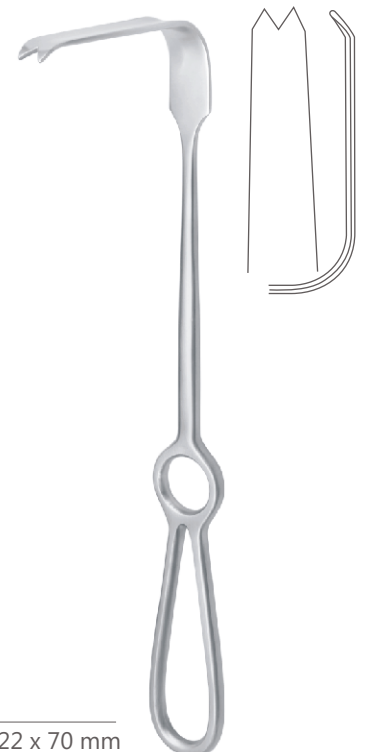

**Obwegeser Ramus Retractor**

Catalog #	Size, Blade Size
PRO-22-283-22	24.5 cm (9 ¾"), 22 x 70 mm



**Obwegeser Ramus Retractor (Nasal Spine Retractor)**

Catalog #	Size, Blade Size
PRO-22-287-22	22 cm (8 ¾"), 45 x 10 mm

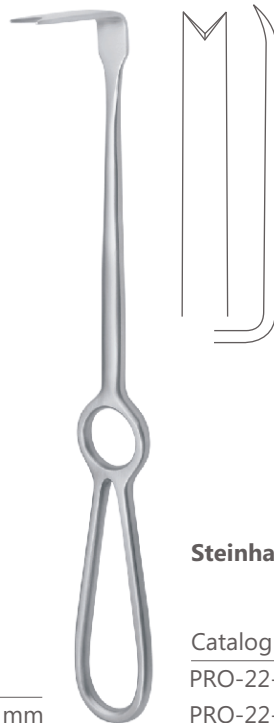

**Obwegeser Ramus Retractor**

Catalog #	Size, Blade Size
PRO-22-289-22	22 cm (8 ¾"), 72 x 10 mm

**Steinhauser Zygomatic Retractor**

Catalog #	Size, Profile
PRO-22-291-01	24 cm (9 ½"), Right
PRO-22-291-02	24 cm (9 ½"), Left

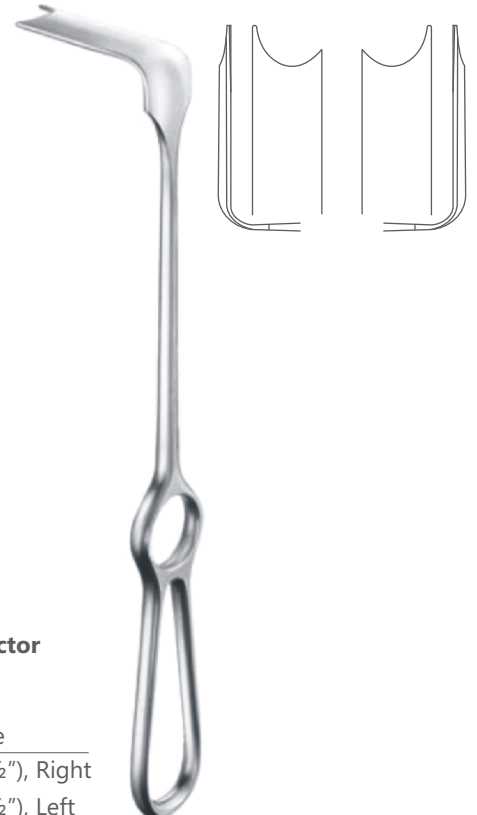



**Obwegeser Chin Retractor**

Catalog #	Size
PRO-22-301-16	16.5 cm (6 1/2")

**Obwegeser Channel Retractor**

Catalog #	Size, Blade Width
PRO-22-305-08	17 cm (6 3/4"), 8 mm
PRO-22-305-10	17 cm (6 3/4"), 10 mm



**Hargis Medial Ramus Retractor**

Catalog #	Size, Profile
PRO-22-315-01	19.5 cm (7 3/4"), Right
PRO-22-315-02	19.5 cm (7 3/4"), Left



**Hargis Mandibular Body Retractor**

Catalog #	Size
PRO-22-319-18	18 cm (7")



**Hargis Anterior Border Stripper**

Catalog #	Size
PRO-22-331-19	19 cm (7 1/2")



**Obwegeser Periosteal Elevator**

Catalog #	Size, Blade Width
PRO-22-361-04	17.5 cm (7"), 4 mm
PRO-22-361-06	17.5 cm (7"), 6 mm
PRO-22-361-07	17.5 cm (7"), 7 mm
PRO-22-361-09	17.5 cm (7"), 9 mm
PRO-22-361-11	17.5 cm (7"), 11 mm

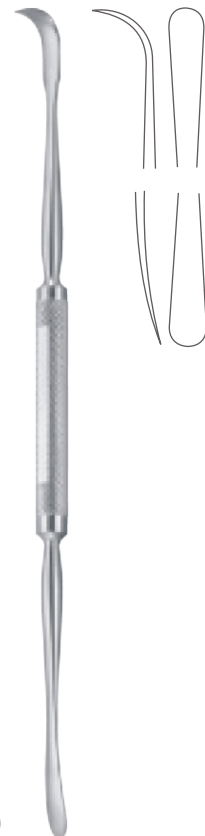

**Obwegeser Elevator  
Fig. 1**

Catalog #	Size
PRO-22-381-21	20.5 cm (8")

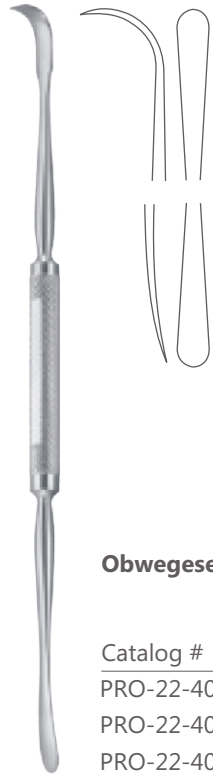

**Obwegeser J-Stripper**

Catalog #	Size, Blade Width
PRO-22-401-05	20.5 cm (8"), 5 mm
PRO-22-401-07	20.5 cm (8"), 7 mm
PRO-22-401-09	20.5 cm (8"), 9 mm

**Obwegeser Elevator**

Fig. 2

Catalog #	Size
PRO-22-383-21	20.5 cm (8")



**Terry Ramus Pusher**

Catalog #	Size
PRO-22-415-24	24 cm (9 1/2")

**Obwegeser Ramus Stripper**

Catalog #	Size, Profile
PRO-22-405-01	17.5 cm (7"), Fig. 1
PRO-22-405-02	17.5 cm (7"), Fig. 2





**Steinhauser Reposition Instrument**

Catalog #	Size
PRO-22-421-18	18 cm (7")

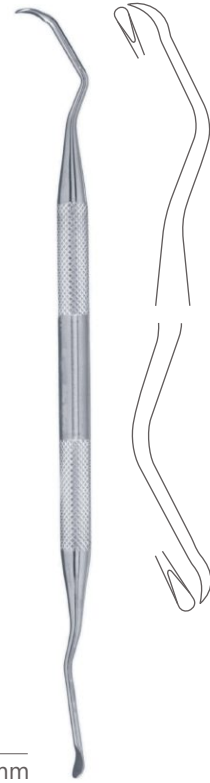

**Tatum Sinus Lift Curette**  
Fig. 1

Catalog #	Size, Blade Width
PRO-22-451-01	18 cm (7"), 2.6 mm - 2.6 mm

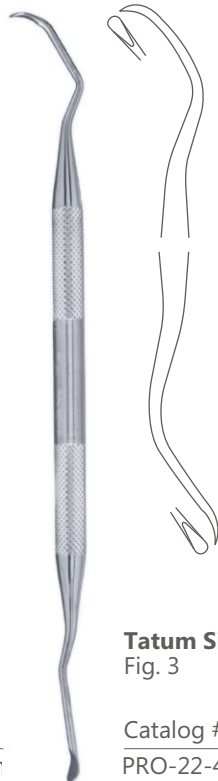

**Tatum Sinus Lift Curette**  
Fig. 2

Catalog #	Size, Blade Width
PRO-22-453-02	17.5 cm (7"), 2.6 mm - 2.6 mm

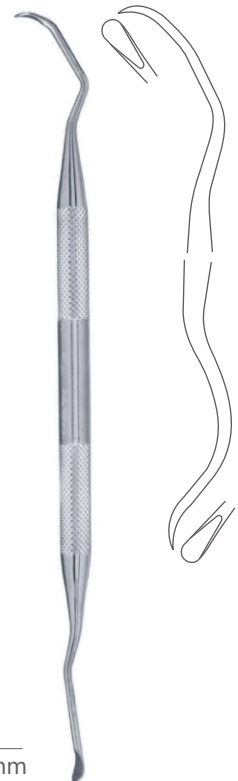

**Tatum Sinus Lift Curette**  
Fig. 3

Catalog #	Size, Blade Width
PRO-22-455-03	18 cm (7"), 4.1 mm - 4.1 mm

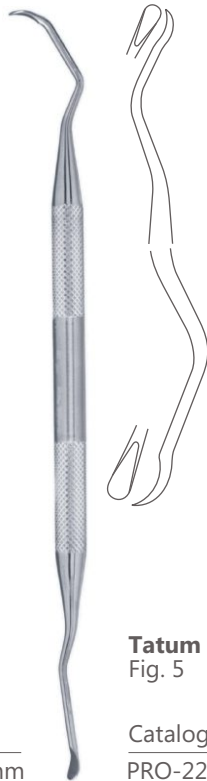

**Tatum Sinus Lift Curette**  
Fig. 4

Catalog #	Size, Blade Width
PRO-22-457-04	18.5 cm (7 ¼"), 4.1 mm - 4.1 mm

**Tatum Sinus Lift Curette**  
Fig. 5

Catalog #	Size, Blade Width
PRO-22-459-05	18.5 cm (7 ¼"), 6.7 mm - 6.7 mm

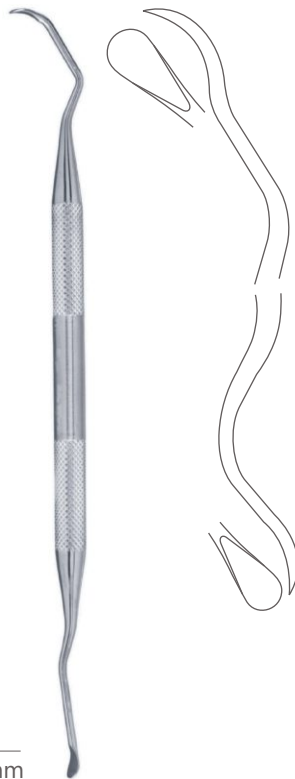
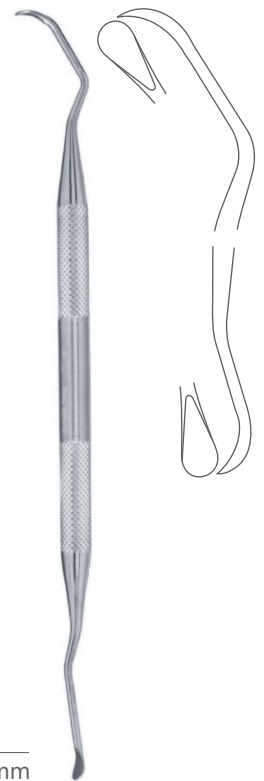

**Tatum Sinus Lift Curette**  
Fig. 6

Catalog #	Size, Blade Width
PRO-22-461-06	19 cm (7 ½"), 6.7 mm - 6.7 mm

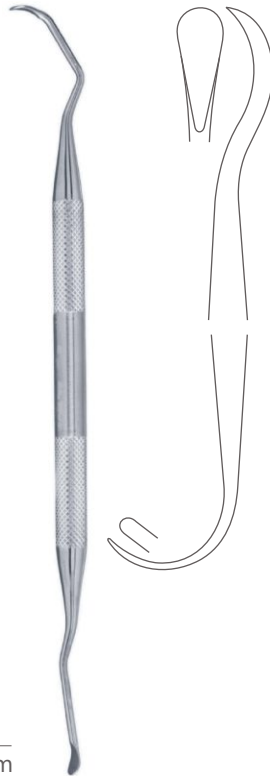

**Tatum Sinus Lift Curette**  
Fig. 7

Catalog #	Size, Blade Width
PRO-22-463-07	16 cm (6 ¼"), 2.8 mm - 6.2 mm

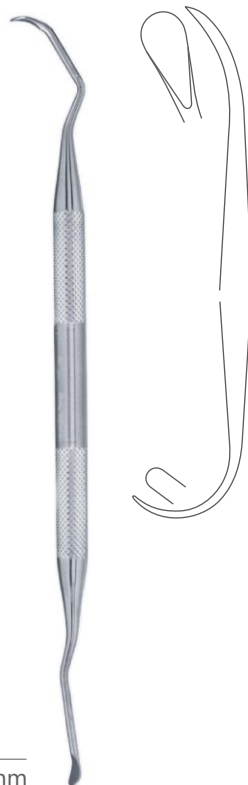

**Tatum Sinus Lift Curette**  
Fig. 8

Catalog #	Size, Blade Width
PRO-22-465-08	16 cm (6 ¼"), 2.8 mm - 6.2 mm



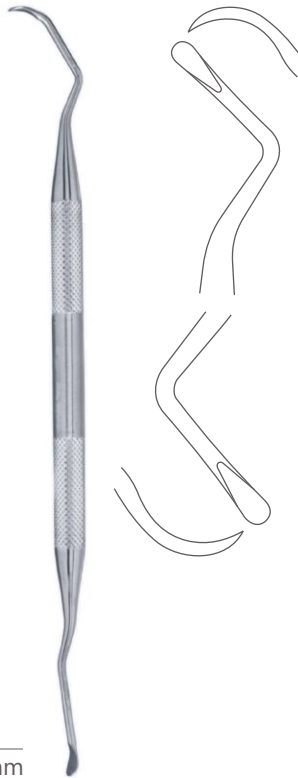

**Tatum Sinus Lift Curette**  
Fig. 9

Catalog #	Size, Blade Width
PRO-22-467-09	15 cm (6"), 3.1 mm - 3.1 mm

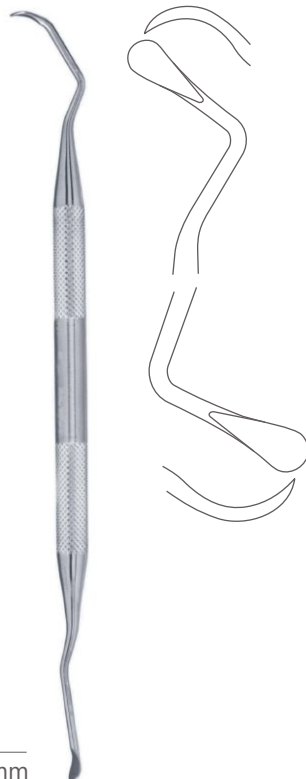

**Tatum Sinus Lift Curette**  
Fig. 10

Catalog #	Size, Blade Width
PRO-22-469-10	17 cm (6 3/4"), 5.6 mm - 5.6 mm



**Obwegeser Maxillary Awl**

Catalog #	Size
PRO-22-501-15	15 cm (6")
PRO-22-501-17	17.5 cm (7")



**Obwegeser Zygomatic Arch Awl**

Catalog #	Size
PRO-22-503-24	24 cm (9 1/2")



**Obwegeser Maxillary Awl**

Catalog #	Size
PRO-22-507-18	18 cm (7")



**Obwegeser Wire Loop Forcep**

Catalog #	Size
PRO-22-540-15	15 cm (6")



**Smith Ramus Separator**

Catalog #	Size
PRO-22-550-20	23.5 cm (9 1/4")

**Smith Sagittal Split Separator**

Catalog #	Size, Profile
PRO-22-554-01	18.5 cm (7 1/4"), Right
PRO-22-554-02	18.5 cm (7 1/4"), Left



**Rowe Disimpaction Forcep**

Catalog #	Size, Profile
PRO-22-570-01	22.5 cm (8 3/4"), Right
PRO-22-570-02	22.5 cm (8 3/4"), Left

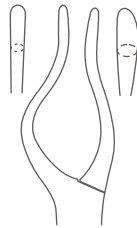



**Gillies Zygoma Elevator**

Catalog #	Size
PRO-22-601-21	20 cm (8")



**Dingman Zygoma Elevator**

Catalog #	Size, Tip Diameter
PRO-22-602-21	21 cm (8 ¼"), Ø 5.0 mm



**Dingman Bone Hook**

Catalog #	Size, Tip Size
PRO-22-613-10	20 cm (8"), 10 mm

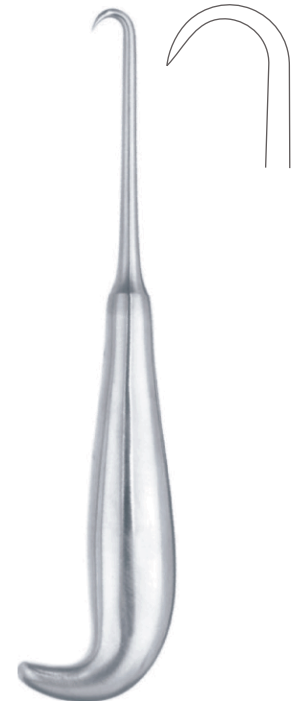

**Dingman Bone Hook**

Catalog #	Size, Tip Size
PRO-22-615-10	20 cm (8"), 20 mm



**Turvey Palatal Expander**

Catalog #	Size
PRO-22-700-17	17 cm (6 3/4")

**Terry Septal Osteotome**

Catalog #	Size
PRO-22-730-19	19 cm (7 1/2")

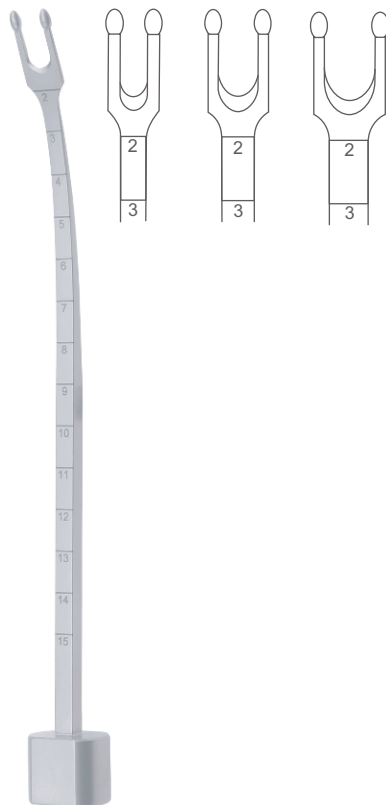

**Obwegeser Septonasal Osteotome**  
Graduated

Catalog #	Size, Blade Width
PRO-22-735-04	18.5 cm (7 1/4"), 4 mm
PRO-22-735-06	18.5 cm (7 1/4"), 6 mm
PRO-22-735-08	18.5 cm (7 1/4"), 8 mm



**FibreGrip™ Obwegeser Wedge Osteotome**

Catalog #	Size, Blade Width
PRO-22-740-08	22 cm (8 ¾"), 8 mm
PRO-22-740-12	22 cm (8 ¾"), 12 mm
PRO-22-747-16	22 cm (8 ¾"), 16 mm

**FibreGrip™ Obwegeser Split Osteotome**

Catalog #	Size, Blade Width
PRO-22-742-08	22 cm (8 ¾"), 8 mm
PRO-22-742-12	22 cm (8 ¾"), 12 mm
PRO-22-742-16	22 cm (8 ¾"), 16 mm
PRO-22-742-20	22 cm (8 ¾"), 20 mm

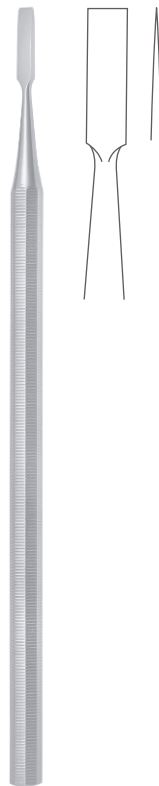

**Obwegeser Osteotome**  
For Alveolar Process

Catalog #	Size, Blade Width
PRO-22-750-03	15 cm (6"), 3 mm
PRO-22-750-04	15 cm (6"), 4 mm
PRO-22-750-06	15 cm (6"), 6 mm