



PRECISION[™]
SURGICAL WORKS

OTOLOGY INSTRUMENTS

Otologie
Otologia
Otologie
Otologia



Hartmann Ear Specula
Set of 3

Catalog #	Size
PRO-23-010-01	Standard



Hartmann Ear Specula
Set of 3

Catalog #	Size
PRO-23-010-02	Standard



Hartmann Ear Specula
Set of 3

Catalog #	Size
PRO-23-010-03	Standard



Hartmann Ear Specula
Set of 3

Catalog #	Size
PRO-23-010-03	Standard



Hartmann Ear Speculum

Catalog #	Size, Diameter, Profile
PRO-23-012-00	3.6 cm (1 ½"), Ø 3.0 mm, Fig. 0
PRO-23-012-01	3.6 cm (1 ½"), Ø 4.0 mm, Fig. 1
PRO-23-012-02	3.6 cm (1 ½"), Ø 5.0 mm, Fig. 2
PRO-23-012-03	3.6 cm (1 ½"), Ø 6.0 mm, Fig. 3
PRO-23-012-04	3.6 cm (1 ½"), Ø 7.0 mm, Fig. 4

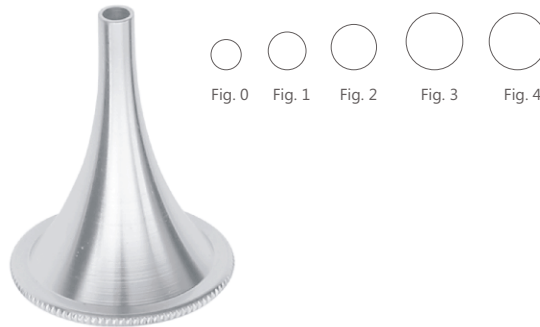

Toynbee Ear Specula

Set of 3

Catalog #	Size
PRO-23-020-01	Standard



Toynbee Ear Speculum

For Adults

Catalog #	Size
PRO-23-022-01	3.6 cm (1 ½"), Ø 4.0 mm, Fig. 1
PRO-23-022-02	3.6 cm (1 ½"), Ø 5.0 mm, Fig. 2
PRO-23-022-03	3.6 cm (1 ½"), Ø 6.0 mm, Fig. 3
PRO-23-022-04	3.6 cm (1 ½"), Ø 7.0 mm, Fig. 4

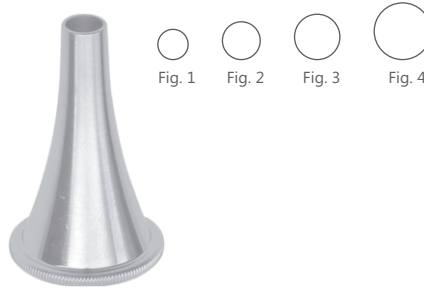

Hartmann Ear Specula (Black)
Set of 3



Catalog #	Size
PRO-23-030-01	Standard

Hartmann Ear Speculum
Black

Catalog #	Size, Profile
PRO-23-032-00	3.6 cm (1 1/2"), Fig. 0
PRO-23-032-01	3.6 cm (1 1/2"), Fig. 1
PRO-23-032-02	3.6 cm (1 1/2"), Fig. 2
PRO-23-032-03	3.6 cm (1 1/2"), Fig. 3
PRO-23-032-04	3.6 cm (1 1/2"), Fig. 4



Zeollner Ear Specula
Set of 6

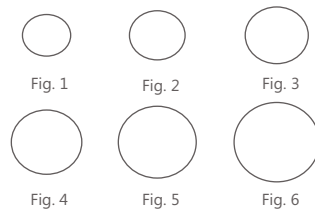

Catalog #	Size
PRO-23-040-01	Standard

Zeollner Ear Speculum
Oval, Black

Catalog #	Size, Tip Size, Profile
PRO-23-042-01	3.8 cm (1 1/2"), 5.5 x 6.5 mm. Fig. 1
PRO-23-042-02	3.8 cm (1 1/2"), 6.5 x 7.5 mm. Fig. 2
PRO-23-042-03	3.8 cm (1 1/2"), 7.5 x 8.5 mm. Fig. 3
PRO-23-042-04	3.8 cm (1 1/2"), 8.5 x 9.5 mm. Fig. 4
PRO-23-042-05	3.8 cm (1 1/2"), 9.5 x 10.5 mm. Fig. 5
PRO-23-042-06	3.8 cm (1 1/2"), 10.5 x 11.5 mm. Fig. 6



Farrior Ear Speculum
Black

Catalog #	Size, Diameter, Profile
PRO-23-052-01	3.6 cm (1 1/2"), Ø 5.5 mm, Fig. 1
PRO-23-052-02	3.6 cm (1 1/2"), Ø 6.5 mm, Fig. 2
PRO-23-052-03	3.6 cm (1 1/2"), Ø 7.5 mm, Fig. 3
PRO-23-052-04	3.6 cm (1 1/2"), Ø 8.5 mm, Fig. 4
PRO-23-052-04	3.6 cm (1 1/2"), Ø 9.5 mm, Fig. 5
PRO-23-052-06	3.6 cm (1 1/2"), Ø 10.5 mm, Fig. 6
PRO-23-052-07	3.6 cm (1 1/2"), Ø 11.5 mm, Fig. 7

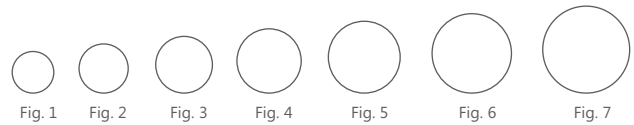

Storage Rack for Ear Specula
For 12 Specula

Catalog #	Size
PRO-23-060-12	Standard

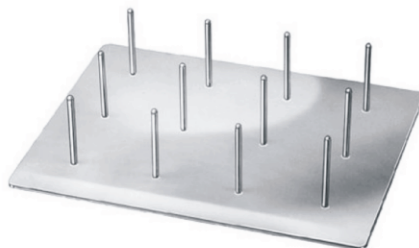

Storage Rack for Ear Specula
For 12 Specula

Catalog #	Diameter
PRO-23-064-02	Ø 2.0 mm
PRO-23-064-04	Ø 3.0 mm
PRO-23-064-06	Ø 4.0 mm

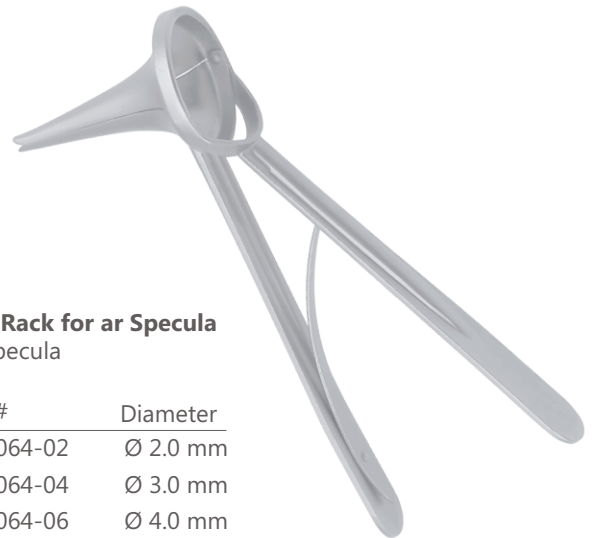

Siegle Otoscope Complete
With 3 Specula



Catalog #	Size
PRO-23-070-00	Standard

Siegle Ear Speculum



Catalog #	Diameter, Profile
PRO-23-072-01	Ø 6.5 mm, Fig. 1
PRO-23-072-02	Ø 7.0 mm, Fig. 2
PRO-23-072-03	Ø 8.0 mm, Fig. 3

Hartmann Tuning Forks
Set of 5



Catalog #	Size
PRO-23-100-10	Standard

Hartmann Tuning Forks
Set of 6



Catalog #	Size
PRO-23-100-20	Standard

Hartmann Tuning Forks
Set of 6



Catalog #	Size
PRO-23-100-30	Standard

Hartmann Tuning Fork

Catalog #	Frequency
PRO-23-102-01	C 128
PRO-23-102-02	C ¹ 256
PRO-23-102-03	C ¹ 512
PRO-23-102-04	C ² 1024
PRO-23-102-05	C ³ 2048
PRO-23-102-06	C ⁴ 4096



Hartmann Tuning Fork (French)

Catalog #	Frequency
PRO-23-104-01	C ² 16
PRO-23-104-02	C ¹ 32
PRO-23-104-03	C 64
PRO-23-104-04	C 128
PRO-23-104-05	C ¹ 256





Tuning Forks
Set of 5

Catalog #	Size
PRO-23-110-00	Standard

Tuning Fork

Catalog #	Frequency
PRO-23-112-02	C 128
PRO-23-112-03	C ¹ 256
PRO-23-112-04	C ² 512
PRO-23-112-05	C ³ 1024
PRO-23-112-06	C ⁴ 2048



Lucae Tuning Fork

Catalog #	Frequency
PRO-23-122-01	C 128
PRO-23-122-02	C ¹ 256
PRO-23-122-03	C ² 512
PRO-23-122-04	C ³ 1024
PRO-23-122-05	C ⁴ 2048
PRO-23-122-06	C ⁵ 4096

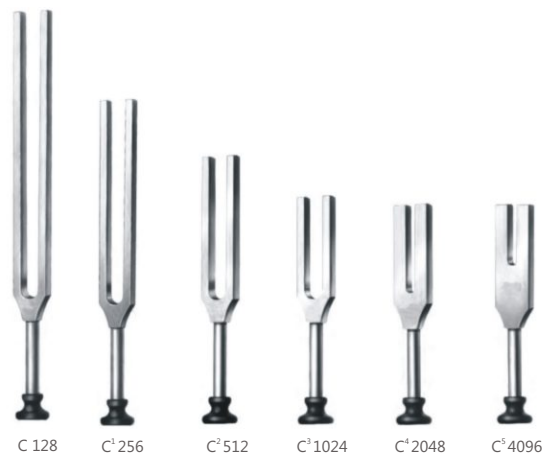

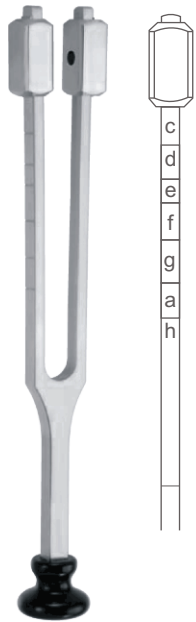

Lucae Tuning Fork
Moveable Up to h

Catalog #	Frequency
PRO-23-126-00	C 128

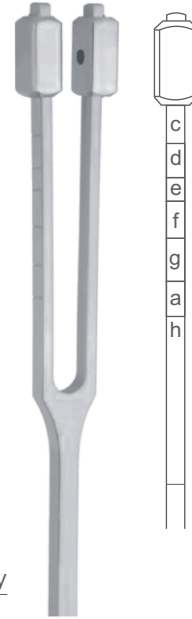

Hartmann Tuning Fork
Moveable up to h

Catalog #	Frequency
PRO-23-128-00	C 128



Hartmann Tuning Fork

Catalog #	Frequency
PRO-23-130-00	C ¹ 256

Rydel-Selfert Tuning Fork
Also for Neurology

Catalog #	Frequency With Dampers, Frequency Without Dampers
PRO-23-134-00	C 64 , C 128





Neuro Tuning Fork
With Hammer, Pinwheel, Brush and Needle

Catalog #	Frequency
PRO-23-136-00	Standard

Koenig Tuning Fork
Moveable Up to g

Catalog #	Frequency
PRO-23-138-00	A 109

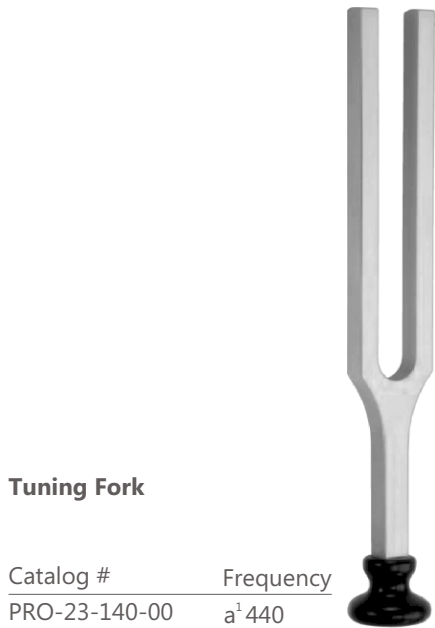
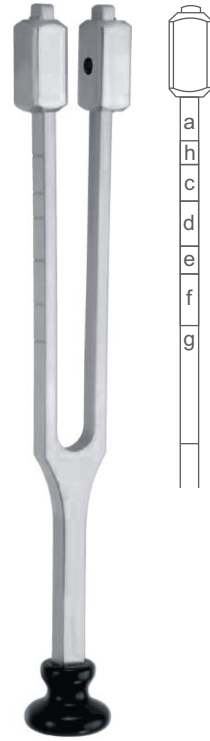

Tuning Fork

Catalog #	Frequency
PRO-23-140-00	a ¹ 440



Hartmann Ear Catheter

Catalog #	Size, Profile
PRO-23-150-01	15 cm (6"), Fig. 1
PRO-23-150-02	15 cm (6"), Fig. 2
PRO-23-150-03	15 cm (6"), Fig. 3



Krausa Polypus Snare
Open Tip

Catalog #	Size
PRO-23-161-18	18.5 cm (7 1/4")



Krausa-Voss Polypus Snare
Close Tip

Catalog #	Size
PRO-23-163-18	18.5 cm (7 1/4")



Lange-Wilde Polypus Snare

Catalog #	Size
PRO-23-165-16	16 cm (6 1/4")

Snare Wire

Catalog #	Size, Diameter
PRO-23-170-30	100 cm (39 1/2"), Ø 0.3 mm
PRO-23-170-40	100 cm (39 1/2"), Ø 0.4 mm

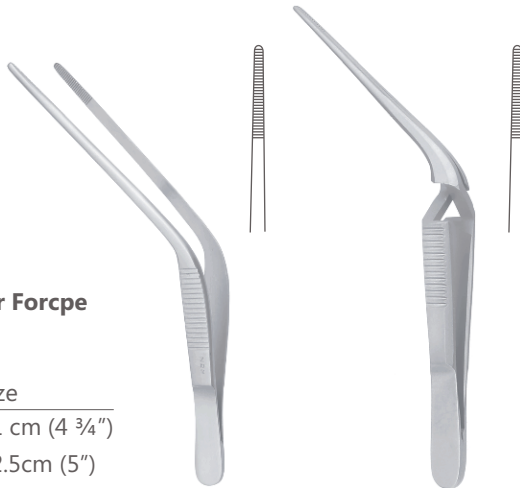

Troeltsch (Wilde) Ear Forceps

Catalog #	Size
PRO-23-201-11	11 cm (4 3/4")
PRO-23-201-13	12.5cm (5")



Troeltsch (Wilde) Ear Forceps

Catalog #	Size
PRO-23-203-11	11 cm (4 3/4")



Troeltsch (Wilde) Ear Forceps
1 x 2 Teeth

Catalog #	Size
PRO-23-205-11	11 cm (4 3/4")



Adson Ear Forceps
Bayonet Shaped

Catalog #	Size
PRO-23-207-18	17.5 cm (7")



Gruenwald (Lucae) Ear Forceps
Bayonet Shaped

Catalog #	Size
PRO-23-211-14	14.5 cm (5 3/4")



Jansen Ear Forcep
Bayonet Shaped

Catalog #	Size
PRO-23-213-16	16 cm (6 ¼")
PRO-23-213-21	21.5 cm (8 ½")



Gruenwald (Lucae) Ear Forcep
1 x 2 Teeth, Bayonet Shaped

Catalog #	Size
PRO-23-215-14	14.5 cm (5 ¾")

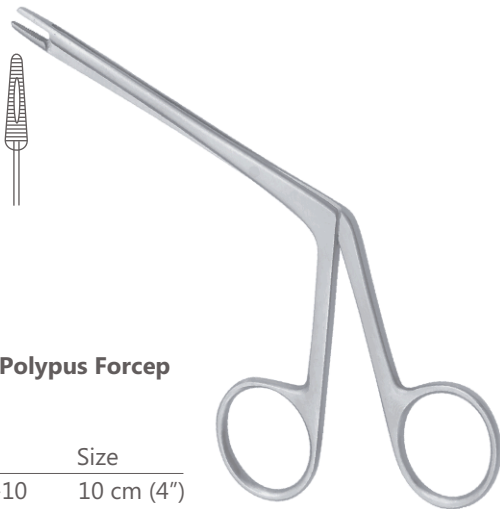

Littauer Ear Polypus Forcep

Catalog #	Size
PRO-23-221-10	10 cm (4")

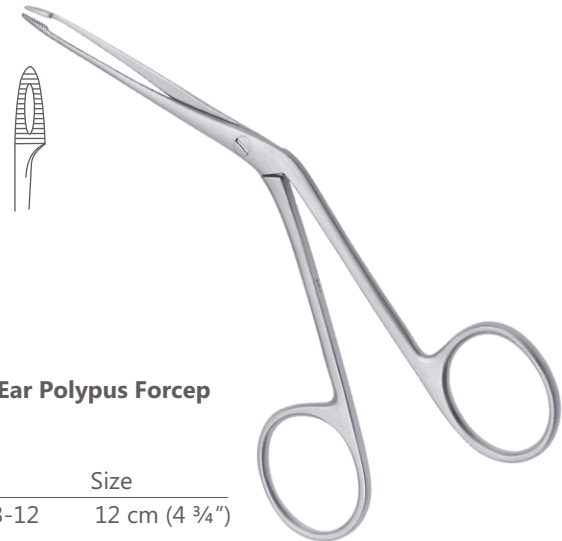

Hartmann Ear Polypus Forcep
Fine Model

Catalog #	Size
PRO-23-223-12	12 cm (4 ¾")

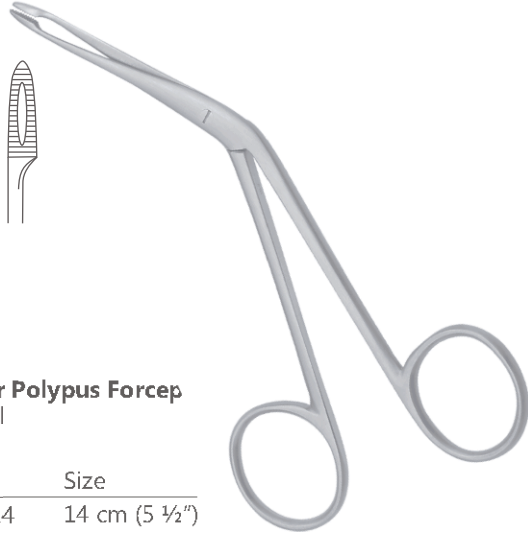

Hartmann Ear Polypus Forcep
Regular Model

Catalog #	Size
PRO-23-225-14	14 cm (5 ½")

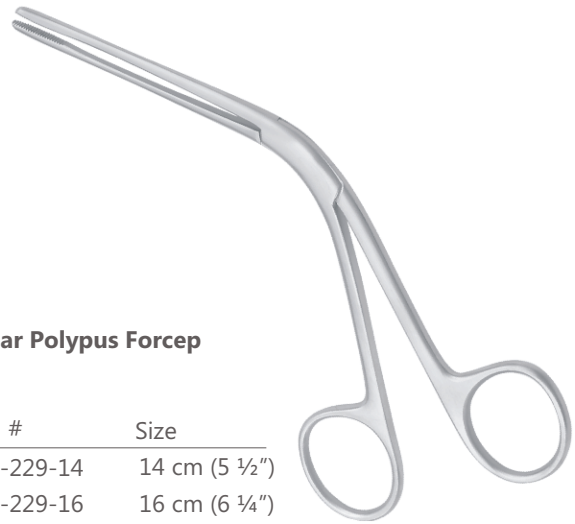

Tilley Ear Polypus Forcep

Catalog #	Size
PRO-23-229-14	14 cm (5 ½")
PRO-23-229-16	16 cm (6 ¼")

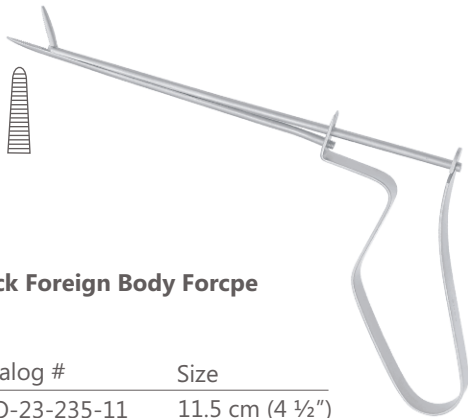

Buck Foreign Body Forcep

Catalog #	Size
PRO-23-235-11	11.5 cm (4 ½")



Quire Foreign Body Forcep

Catalog #	Size
PRO-23-237-10	10.5 cm (4")



Hartmann-Wullstein Alligator Forcep

Catalog #	Size
PRO-23-251-08	8.5 cm (3 1/4")



**Hartmann-Wullstein Alligator Forcep
Cup Shaped**

Catalog #	Size, Diameter
PRO-23-253-08	8.5 cm (3 1/4"), Ø 1.0 mm



Hartmann Alligator Forcep

Catalog #	Size
PRO-23-255-08	8.5 cm (3 1/4")
PRO-23-255-14	14 cm (5 1/2")
PRO-23-255-16	16 cm (6 1/4")

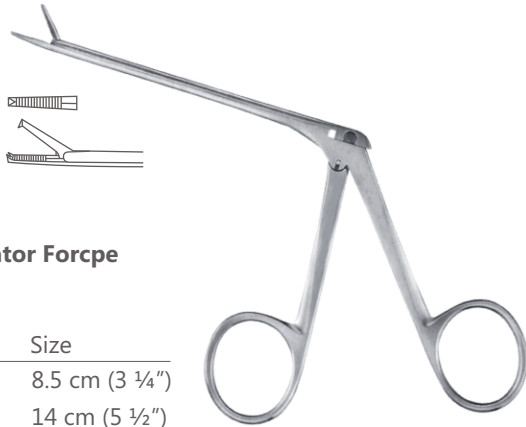

Hartmann Alligator Forcep
1 x 2 Teeth

Catalog #	Size
PRO-23-257-08	8.5 cm (3 1/4")
PRO-23-257-14	14 cm (5 1/2")



Hartmann Alligator Forcep
Cup Shaped

Catalog #	Size
PRO-23-261-20	8.5 cm (3 1/4"), Ø 2.0 mm
PRO-23-261-25	8.5 cm (3 1/4"), Ø 2.5 mm
PRO-23-261-30	8.5 cm (3 1/4"), Ø 3.0 mm



Hartmann Alligator Forcep
Bent Upwards, Cup Shaped

Catalog #	Size, Diameter
PRO-23-263-20	8.5 cm (3 1/4"), Ø 2.0 mm
PRO-23-263-30	8.5 cm (3 1/4"), Ø 3.0 mm



Struempel Alligator Forcep

Catalog #	Size
PRO-23-265-08	8.5 cm (3 1/4")



Hartmann-Weingartner Alligator Forcep

Catalog #	Size
PRO-23-267-08	8.5 cm (3 1/4")



Hartmann-Hoffmar Alligator Punch Forcep

Catalog #	Size
PRO-23-271-08	8.5 cm (3 1/4")



McGee Micro Alligator Forceps
Smooth, Straight

Catalog #	Size, Jaw Size
PRO-23-281-08	8 cm (3"), 4.0 x 0.8 mm



McGee Micro Alligator Forceps
Serrated, Straight

Catalog #	Size, Jaw Size
PRO-23-283-08	8 cm (3"), 4.0 x 0.8 mm



McGee Micro Alligator Forceps
Serrated, Bent Upwards

Catalog #	Size, Jaw Size
PRO-23-285-08	8 cm (3"), 4.0 x 0.8 mm



McGee Micro Alligator Forcep
Serrated, Right

Catalog #	Size, Jaw Size
PRO-23-287-08	8 cm (3"), 4.0 x 0.8 mm

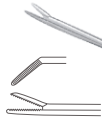

McGee Micro Alligator Forcep
Serrated, Left

Catalog #	Size, Jaw Size
PRO-23-289-08	8 cm (3"), 4.0 x 0.8 mm



Mini-McGee Micro Alligator Forcep
Smooth, Straight

Catalog #	Size, Jaw Size
PRO-23-291-08	8 cm (3"), 3.5 x 0.6 mm



Mini-McGee Micro Alligator Forcep
Serrated, Straight

Catalog #	Size, Jaw Size
PRO-23-293-08	8 cm (3"), 3.5 x 0.6 mm

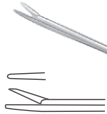

Micro Alligator Forcep
Smooth, Straight

Catalog #	Size, Jaw Size
PRO-23-301-08	8 cm (3"), 4.0 x 0.6 mm

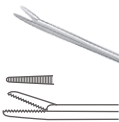

Micro Alligator Forcep
Serrated, Straight

Catalog #	Size, Jaw Size
PRO-23-303-08	8 cm (3"), 4.0 x 0.6 mm



Micro Alligator Forcep
Serrated, Bent Upwards

Catalog #	Size, Jaw Size
PRO-23-305-08	8 cm (3"), 4.0 x 0.6 mm



Micro Alligator Forcep
Serrated, Right

Catalog #	Size, Jaw Size
PRO-23-307-08	8 cm (3"), 4.0 x 0.6 mm



Micro Alligator Forcep
Serrated, Left

Catalog #	Size, Jaw Size
PRO-23-309-08	8 cm (3"), 4.0 x 0.6 mm



Micro Alligator Forcep
Straights, Cup Shaped

Catalog #	Size, Cup Size, Jaw Size
PRO-23-311-08	8 cm (3"), 1.0 x 0.9 mm, 4.0 mm



Micro Alligator Forcep
Bent Upwards, Cup Shaped

Catalog #	Size, Cup Size, Jaw Size
PRO-23-313-08	8 cm (3"), 1.0 x 0.9 mm, 4.0 mm



Micro Alligator Forcep
Right, Cup Shaped

Catalog #	Size, Cup Size, Jaw Size
PRO-23-315-08	8 cm (3"), 1.0 x 0.9 mm, 4.0 mm



Micro Alligator Forcep
Left, Cup Shaped

Catalog #	Size, Cup Size, Jaw Size
PRO-23-317-08	8 cm (3"), 1.0 x 0.9 mm, 4.0 mm



Micro Alligator Forcep
Straight, Cup Shaped

Catalog #	Size, Cup Size, Jaw Size
PRO-23-321-08	8 cm (3"), 0.6 x 0.5 mm, 3.5 mm



Micro Alligator Forceps
Bent Upwards, Cup Shaped

Catalog #	Size, Cup Size, Jaw Size
PRO-23-323-08	8 cm (3"), 0.6 x 0.5 mm, 3.5 mm



Micro Alligator Forceps
Right, Cup Shaped

Catalog #	Size, Cup Size, Jaw Size
PRO-23-325-08	8 cm (3"), 0.6 x 0.5 mm, 3.5 mm



Micro Alligator Forceps
Left, Cup Shaped

Catalog #	Size, Cup Size, Jaw Size
PRO-23-327-08	8 cm (3"), 0.6 x 0.5 mm, 3.5 mm



Bellucci Micro Scissor
Straight, Very Fine

Catalog #	Size, Blade Size
PRO-23-331-08	8 cm (3"), 4.0 x 0.8 mm



Bellucci Micro Scissor
Bent Upwards, Very Fine

Catalog #	Size, Blade Size
PRO-23-333-08	8 cm (3"), 4.0 x 0.8 mm



Bellucci Micro Scissor
Right, Very Fine

Catalog #	Size, Blade Size
PRO-23-335-08	8 cm (3"), 4.0 x 0.8 mm



Bellucci Micro Scissor
Left, Very Fine

Catalog #	Size, Blade Size
PRO-23-337-08	8 cm (3"), 4.0 x 0.8 mm



Wullstein Micro Scissor
Straight

Catalog #	Size, Blade Size
PRO-23-341-08	8 cm (3"), 4.0 x 1.8 mm



Wullstein Micro Scissor
Bent Upwards

Catalog #	Size, Blade Size
PRO-23-343-08	8 cm (3"), 4.0 x 1.8 mm

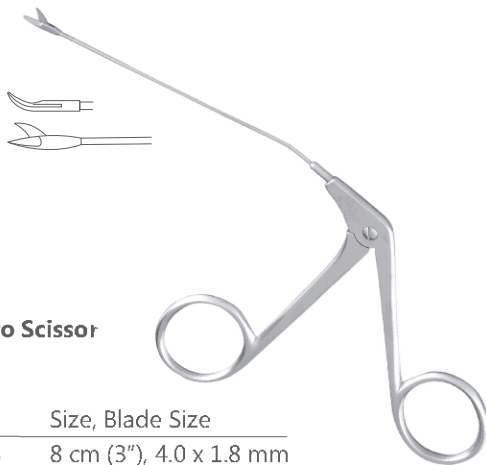

Wullstein Micro Scissor
Right

Catalog #	Size, Blade Size
PRO-23-345-08	8 cm (3"), 4.0 x 1.8 mm



Wullstein Micro Scissor
Left

Catalog #	Size, Blade Size
PRO-23-347-08	8 cm (3"), 4.0 x 1.8 mm

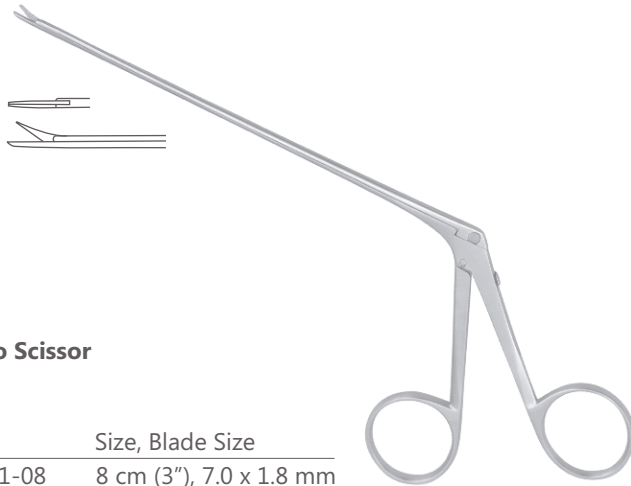

Shea Micro Scissor
Straight

Catalog #	Size, Blade Size
PRO-23-351-08	8 cm (3"), 7.0 x 1.8 mm

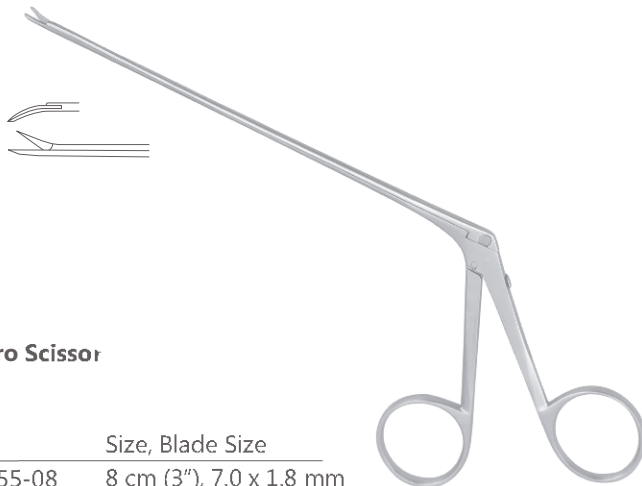

Shea Micro Scissor
Right

Catalog #	Size, Blade Size
PRO-23-355-08	8 cm (3"), 7.0 x 1.8 mm

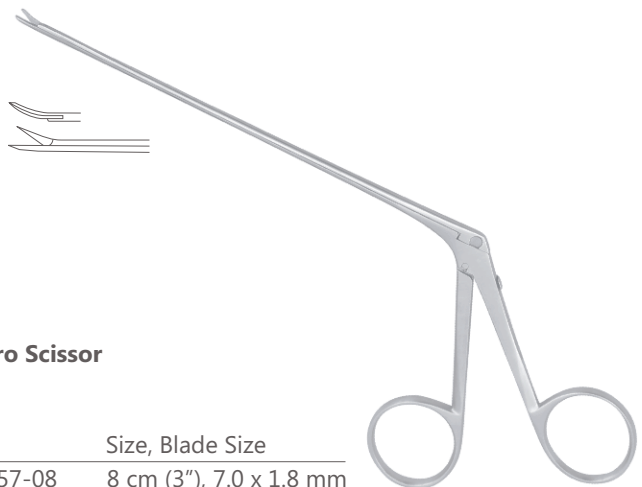

Shea Micro Scissor
Left

Catalog #	Size, Blade Size
PRO-23-357-08	8 cm (3"), 7.0 x 1.8 mm

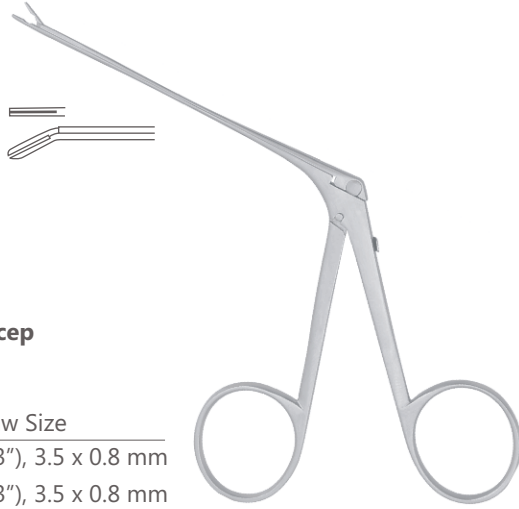

McGee Wire Bending Forcep
Bent Downwards

Catalog #	Size, Jaw Size
PRO-23-361-01	8 cm (3"), 3.5 x 0.8 mm
PRO-23-361-02	8 cm (3"), 3.5 x 0.8 mm

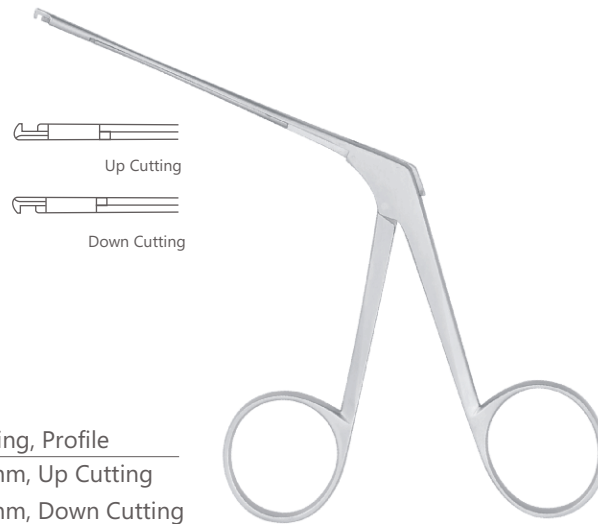

House-Dieter Malleus Nipper

Catalog #	Size, Jaw Opening, Profile
PRO-23-365-01	8 cm (3"), 1.3 mm, Up Cutting
PRO-23-365-02	8 cm (3"), 1.3 mm, Down Cutting

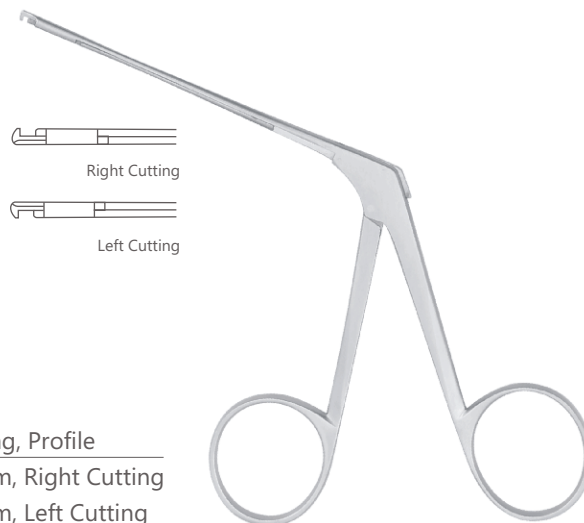

House-Dieter Malleus Nipper

Catalog #	Size, Jaw Opening, Profile
PRO-23-365-03	8 cm (3"), 1.3 mm, Right Cutting
PRO-23-365-04	8 cm (3"), 1.3 mm, Left Cutting



Fuller Introducing Frocep
For Teflon Prosthesis

Catalog #	Size
PRO-23-367-08	8 cm (3")



Schuknecht Rotary Knife

Catalog #	Size
PRO-23-401-01	15 cm (6")
PRO-23-401-02	15 cm (6")

Schuknecht Sickle Knife

Catalog #	Size
PRO-23-403-15	14.5 cm (5 ¾")

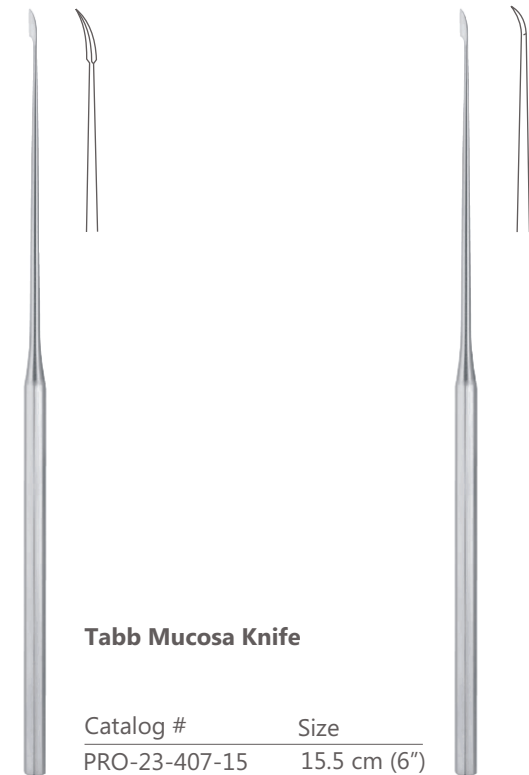

Wullstein Sickle Knife

Catalog #	Size
PRO-23-405-15	15.5 cm (6")

Tabb Mucosa Knife

Catalog #	Size
PRO-23-407-15	15.5 cm (6")



Rosen Circular Cut Knife

Catalog #	Size, Diameter, Profile
PRO-23-421-01	15 cm (6"), Ø 3.0 mm, Fig. 1
PRO-23-421-02	15 cm (6"), Ø 2.8 mm, Fig. 2
PRO-23-421-03	15 cm (6"), Ø 2.6 mm, Fig. 3
PRO-23-421-04	15 cm (6"), Ø 2.0 mm, Fig. 4
PRO-23-421-05	15 cm (6"), Ø 1.6 mm, Fig. 5
PRO-23-421-06	15 cm (6"), Ø 1.4 mm, Fig. 6
PRO-23-421-07	15 cm (6"), Ø 1.0 mm, Fig. 7

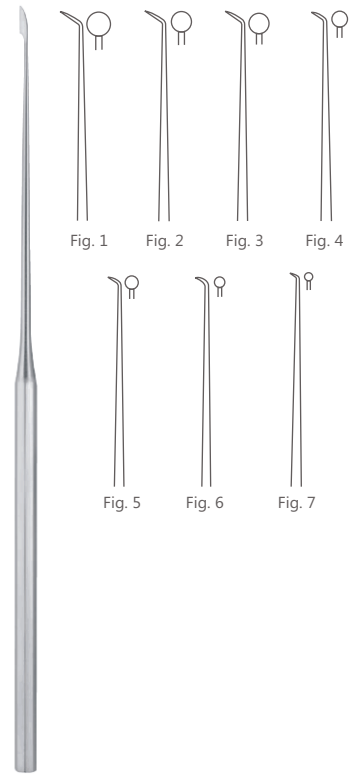

Plester Flap Knife

Catalog #	Size
PRO-23-409-15	15 cm (6")



Barbara Micro Ear Pick

Catalog #	Size
PRO-23-450-16	16 cm (6 ¼")



Barbara Micro Ear Pick Angled

Catalog #	Size
PRO-23-451-16	16 cm (6 ¼")



Rosen Micro Ear Pick

Catalog #	Size
PRO-23-455-16	16 cm (6 ¼")



Barbara Micro Ear Pick

Catalog #	Size
PRO-23-453-16	16 cm (6 ¼")



Barbara Micro Ear Pick
Angled 45°

Catalog #	Size, Tip Size
PRO-23-461-03	16 cm (6 ¼"), 0.3 mm
PRO-23-461-06	16 cm (6 ¼"), 0.6 mm
PRO-23-461-10	16 cm (6 ¼"), 1.0 mm
PRO-23-461-12	16 cm (6 ¼"), 1.2 mm
PRO-23-461-15	16 cm (6 ¼"), 1.5 mm
PRO-23-461-20	16 cm (6 ¼"), 2.0 mm
PRO-23-461-25	16 cm (6 ¼"), 2.5 mm

Barbara Micro Ear Pick
Angled 25°

Catalog #	Size, Tip Size
PRO-23-459-03	16 cm (6 ¼"), 0.3 mm
PRO-23-459-06	16 cm (6 ¼"), 0.6 mm
PRO-23-459-10	16 cm (6 ¼"), 1.0 mm



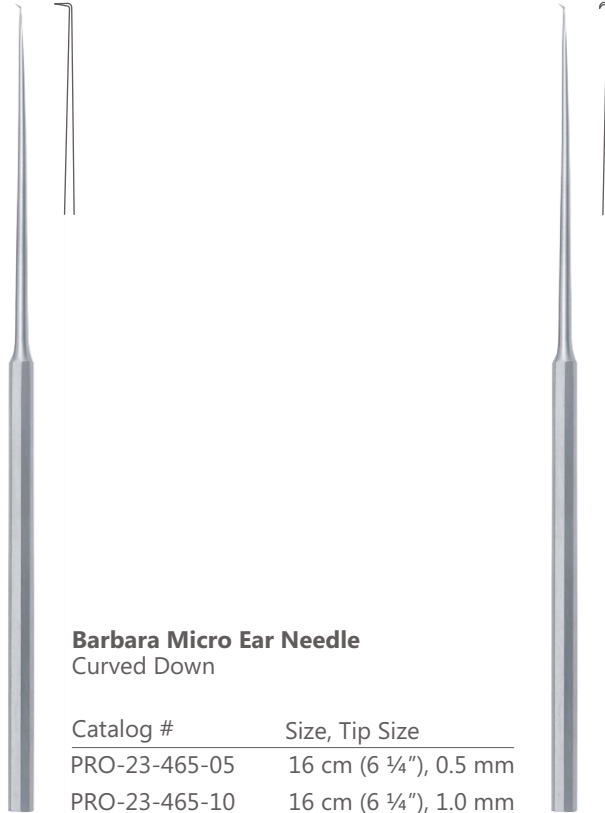

Barbara Micro Ear Pick
Angled 90°

Catalog #	Size, Tip Size
PRO-23-463-03	16 cm (6 ¼"), 0.3 mm
PRO-23-463-06	16 cm (6 ¼"), 0.6 mm
PRO-23-463-10	16 cm (6 ¼"), 1.0 mm
PRO-23-463-12	16 cm (6 ¼"), 1.2 mm
PRO-23-463-15	16 cm (6 ¼"), 1.5 mm
PRO-23-463-20	16 cm (6 ¼"), 2.0 mm
PRO-23-463-25	16 cm (6 ¼"), 2.5 mm

Barbara Micro Ear Needle
Curved Down

Catalog #	Size, Tip Size
PRO-23-465-05	16 cm (6 ¼"), 0.5 mm
PRO-23-465-10	16 cm (6 ¼"), 1.0 mm

Micro Ear Needle
Angled 90°

Catalog #	Size, Tip Size
PRO-23-467-03	15.5 cm (6"), 0.3 mm
PRO-23-467-06	15.5 cm (6"), 0.6 mm
PRO-23-467-10	15.5 cm (6"), 1.0 mm

McGee Micro Ear Needle
For Footplate

Catalog #	Size, Tip Size
PRO-23-473-05	15.5 cm (6"), 0.5 mm
PRO-23-473-10	15.5 cm (6"), 1.0 mm

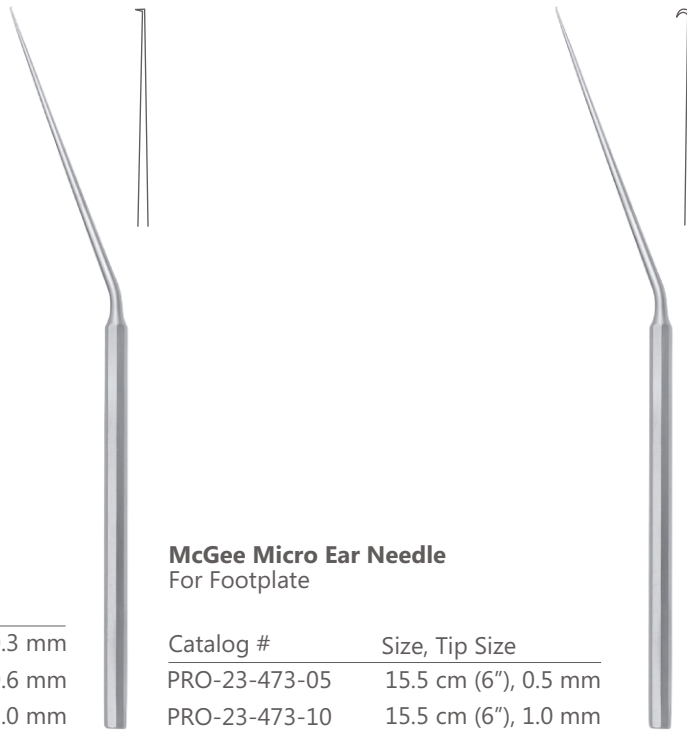



Micro Ear Pick
Angled 25°

Catalog #	Size, Tip Size
PRO-23-481-03	15.5 cm (6"), 0.3 mm
PRO-23-481-06	15.5 cm (6"), 0.6 mm
PRO-23-481-10	15.5 cm (6"), 1.0 mm



Micro Ear Pick
Angled 45°

Catalog #	Size, Tip Size
PRO-23-485-03	15.5 cm (6"), 0.3 mm
PRO-23-485-06	15.5 cm (6"), 0.6 mm
PRO-23-485-10	15.5 cm (6"), 1.0 mm



Micro Ear Needle
Angled 25°

Catalog #	Size, Tip Size
PRO-23-491-03	15.5 cm (6"), 0.3 mm
PRO-23-491-06	15.5 cm (6"), 0.6 mm



Shambaugh Micro Ear Needle
Angled 25°

Catalog #	Size, Tip Size
PRO-23-491-10	15.5 cm (6"), 1.0 mm



Micro Ear Needle
Angled 45°

Catalog #	Size, Tip Size
PRO-23-493-03	15.5 cm (6"), 0.3 mm
PRO-23-493-06	15.5 cm (6"), 0.6 mm

Shambaugh Micro Ear Needle
Angled 45°

Catalog #	Size, Tip Size
PRO-23-493-10	15.5 cm (6"), 1.0 mm

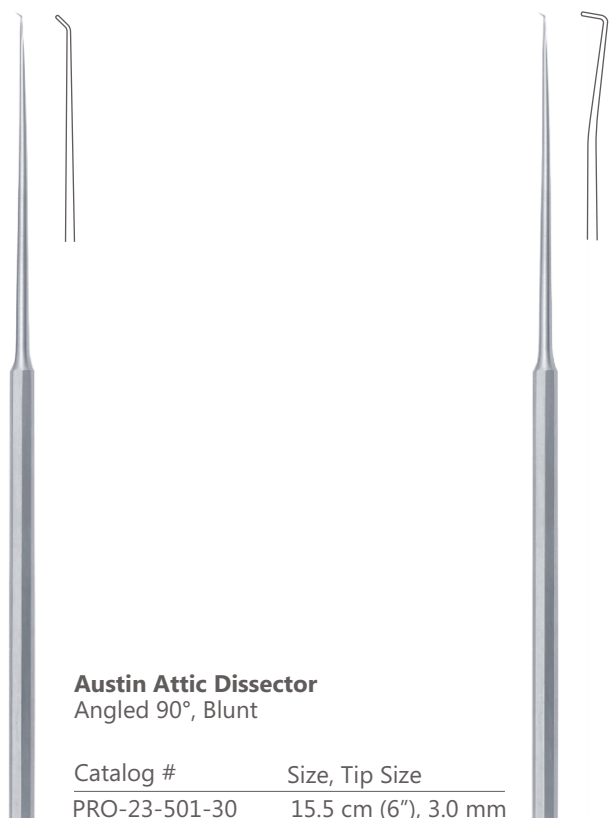

Shea Exploring Hook
Angled 45°, Blunt

Catalog #	Size, Tip Size
PRO-23-497-20	15.5 cm (6"), 2.0 mm

Austin Attic Dissector
Angled 90°, Blunt

Catalog #	Size, Tip Size
PRO-23-501-30	15.5 cm (6"), 3.0 mm



Fisch Micro Dissector

Catalog #	Size, Profile
PRO-23-505-01	15.5 cm (6"), Angled to Right
PRO-23-505-02	15.5 cm (6"), Angled to Left
PRO-23-505-03	15.5 cm (6"), Angled to Right
PRO-23-505-04	15.5 cm (6"), Angled to Left

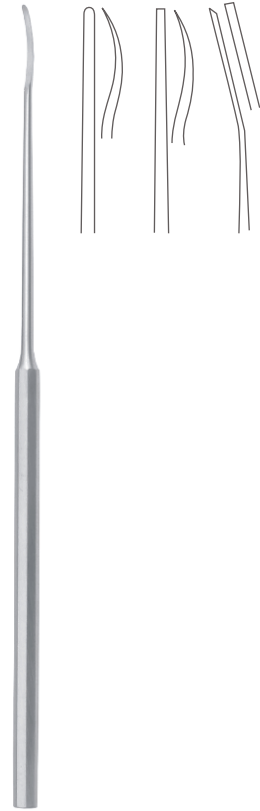

Rosen Micro Ear Periosteal Elevator

Catalog #	Size
PRO-23-509-01	15.5 cm (6")
PRO-23-509-02	15.5 cm (6")
PRO-23-509-03	15.5 cm (6")



Rosen Micro Curette

Catalog #	Size
PRO-23-509-04	15.5 cm (6")

Rosen Micro Dissector

Catalog #	Size
PRO-23-509-05	15.5 cm (6")
PRO-23-509-06	15.5 cm (6")





House Micro Measuring Rod

Catalog #	Size, Tip Size
PRO-23-511-01	15.5 cm (6"), 3.5 mm
PRO-23-511-02	15.5 cm (6"), 4.0 mm
PRO-23-511-03	15.5 cm (6"), 4.5 mm
PRO-23-511-04	15.5 cm (6"), 5.0 mm

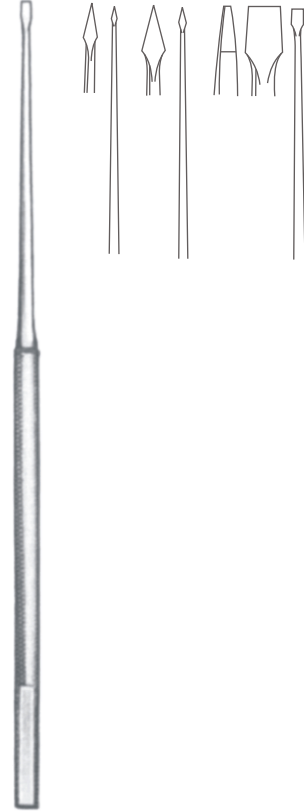

Buckingham Chisel

Catalog #	Size, Tip Size
PRO-23-515-01	18 cm (7"), 0.5 mm
PRO-23-515-02	18 cm (7"), 1.0 mm
PRO-23-515-04	18 cm (7"), 1.5 mm



Dingman Otoprader

Catalog #	Size, Profile
PRO-23-517-01	Standard, Left
PRO-23-517-02	Standard, Right

House Micro Ear Curette

Catalog #	Size, Cup Size 1, Cup Size 2
PRO-23-520-01	14.5 cm (5 3/4"), 1.0 mm, 1.2 mm
PRO-23-520-02	14.5 cm (5 3/4"), 1.5 mm, 1.8 mm
PRO-23-520-03	14.5 cm (5 3/4"), 1.0 mm, 1.2 mm
PRO-23-520-04	14.5 cm (5 3/4"), 1.5 mm, 1.8 mm





Shea Micro Ear Curette

Catalog #	Size
PRO-23-525-14	14.5 cm (5 3/4")



Zoellner Micro Ear Needle
Straight

Catalog #	Size
PRO-23-535-01	Standard

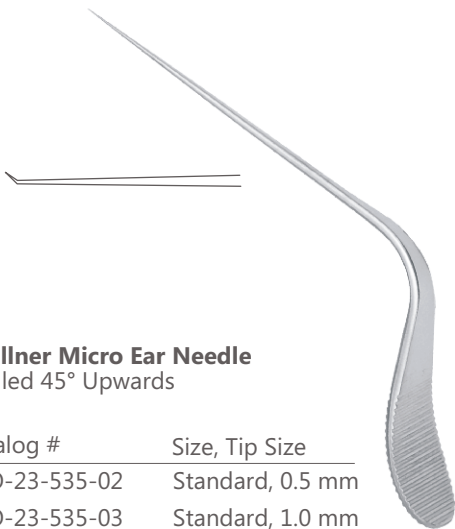

Zoellner Micro Ear Needle
Angled 45° Upwards

Catalog #	Size, Tip Size
PRO-23-535-02	Standard, 0.5 mm
PRO-23-535-03	Standard, 1.0 mm



Zoellner Micro Ear Needle
Angled 45° Downwards

Catalog #	Size, Tip Size
PRO-23-535-04	Standard, 0.5 mm
PRO-23-535-05	Standard, 1.0 mm



Zoellner Micro Ear Needle
Angled 90° Upwards

Catalog #	Size, Tip Size
PRO-23-535-06	Standard, 0.5 mm



Zoellner Micro Ear Needle
Angled 90° Downwards

Catalog #	Size, Tip Size
PRO-23-535-06	Standard, 0.5 mm



Zoellner Micro Ear Needle
For Footplate

Catalog #	Size, Tip Size
PRO-23-535-08	Standard, 1.0 mm
PRO-23-535-09	Standard, 1.0 mm



Zoellner Ear Knife
Angled 90° Upwards

Catalog #	Size
PRO-23-535-10	Standard



Zoellner Ear Knife
Angled 90° Downwards

Catalog #	Size
PRO-23-535-11	Standard



Zoellner Micro Ear Knife
Angled Upwards

Catalog #	Size
PRO-23-535-12	Standard



Zoellner Micro Ear Knife
Angled Downwards

Catalog #	Size
PRO-23-535-13	Standard

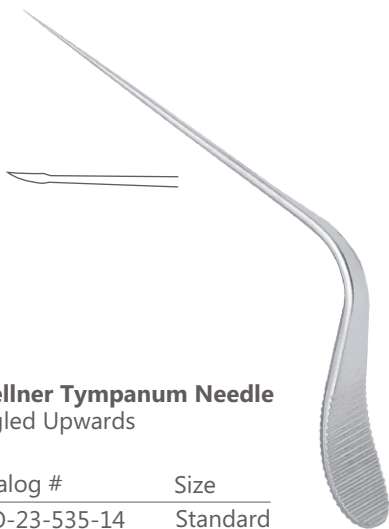

Zoellner Tympanum Needle
Angled Upwards

Catalog #	Size
PRO-23-535-14	Standard

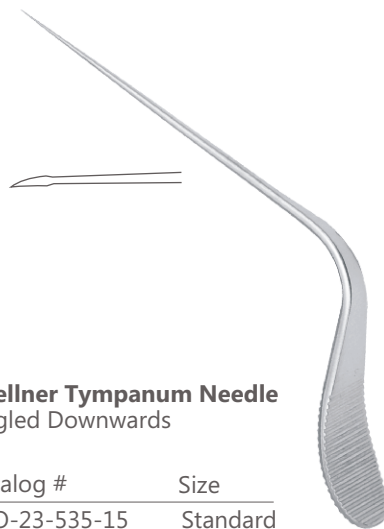

Zoellner Tympanum Needle
Angled Downwards

Catalog #	Size
PRO-23-535-15	Standard

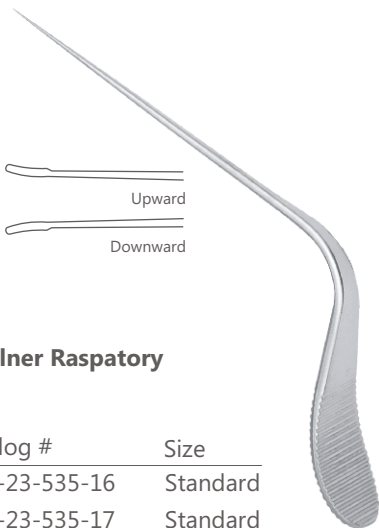

Zoellner Raspatory

Catalog #	Size
PRO-23-535-16	Standard
PRO-23-535-17	Standard

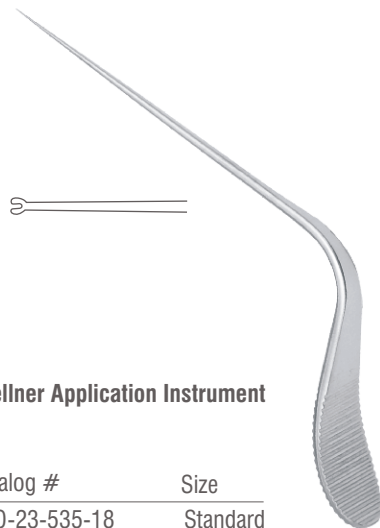

Zoellner Application Instrument

Catalog #	Size
PRO-23-535-18	Standard



Langenbeck Ear Curette
Blunt

Catalog #	Size
PRO-23-551-13	13 cm (5")

Shapleigh Ear Curette

Catalog #	Size, Profile
PRO-23-555-01	15 cm (6"), Fig. 1
PRO-23-555-02	15 cm (6"), Fig. 2



Buck Ear Curette
Straight, Blunt

Catalog #	Size, Profile
PRO-23-570-01	17 cm (6 3/4"), Fig. 000
PRO-23-570-02	17 cm (6 3/4"), Fig. 00
PRO-23-570-10	17 cm (6 3/4"), Fig. 0
PRO-23-570-11	17 cm (6 3/4"), Fig. 1
PRO-23-570-12	17 cm (6 3/4"), Fig. 2
PRO-23-570-13	17 cm (6 3/4"), Fig. 3
PRO-23-570-14	17 cm (6 3/4"), Fig. 4

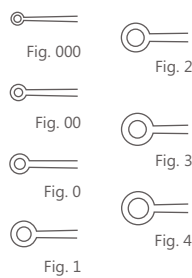

Buck Ear Curette
Angled, Blunt

Catalog #	Size, Profile
PRO-23-571-01	17 cm (6 3/4"), Fig. 000
PRO-23-571-02	17 cm (6 3/4"), Fig. 00
PRO-23-571-10	17 cm (6 3/4"), Fig. 0
PRO-23-571-11	17 cm (6 3/4"), Fig. 1
PRO-23-571-12	17 cm (6 3/4"), Fig. 2
PRO-23-571-13	17 cm (6 3/4"), Fig. 3
PRO-23-571-14	17 cm (6 3/4"), Fig. 4

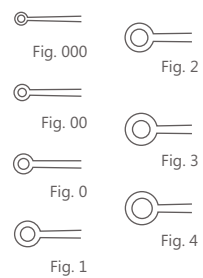
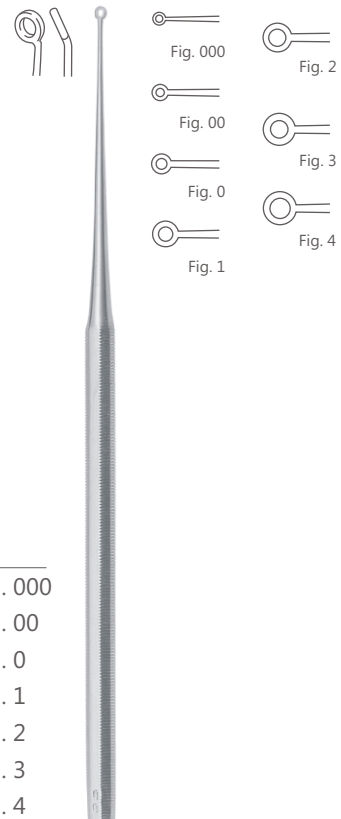

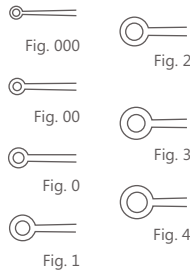

Buck Ear Curette
Straight, Sharp

Catalog #	Size, Profile
PRO-23-572-01	17 cm (6 3/4"), Fig. 000
PRO-23-572-02	17 cm (6 3/4"), Fig. 00
PRO-23-572-10	17 cm (6 3/4"), Fig. 0
PRO-23-572-11	17 cm (6 3/4"), Fig. 1
PRO-23-572-12	17 cm (6 3/4"), Fig. 2
PRO-23-572-13	17 cm (6 3/4"), Fig. 3
PRO-23-572-14	17 cm (6 3/4"), Fig. 4

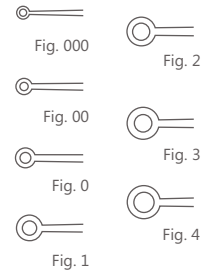

Buck Ear Curette
Angled, Sharp

Catalog #	Size, Profile
PRO-23-573-01	17 cm (6 3/4"), Fig. 000
PRO-23-573-02	17 cm (6 3/4"), Fig. 00
PRO-23-573-10	17 cm (6 3/4"), Fig. 0
PRO-23-573-11	17 cm (6 3/4"), Fig. 1
PRO-23-573-12	17 cm (6 3/4"), Fig. 2
PRO-23-573-13	17 cm (6 3/4"), Fig. 3
PRO-23-573s-14	17 cm (6 3/4"), Fig. 4

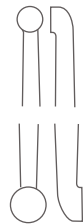

Jansen Ear Scoop
Sharp

Catalog #	Size
PRO-23-576-15	17 cm (6 3/4")



Barth Ear Scoop
Sharp

Catalog #	Size
PRO-23-580-18	18 cm (7")



Lempert Ear Scoop
Sharp

Catalog #	Size, Profile
PRO-23-600-10	21.5 cm (8 ½"), Fig. 0
PRO-23-600-20	21.5 cm (8 ½"), Fig. 00
PRO-23-600-30	21.5 cm (8 ½"), Fig. 000
PRO-23-600-40	21.5 cm (8 ½"), Fig. 0000
PRO-23-600-50	21.5 cm (8 ½"), Fig. 00000



Gross Ear Scoop-Hook
Blunt

Catalog #	Size
PRO-23-583-13	13 cm (5")



FiberGrip™ Lempert Ear Scoop
Sharp

Catalog #	Size, Profile
PRO-23-610-10	21.5 cm (8 ½"), Fig. 0
PRO-23-610-20	21.5 cm (8 ½"), Fig. 00
PRO-23-610-30	21.5 cm (8 ½"), Fig. 000
PRO-23-610-40	21.5 cm (8 ½"), Fig. 0000
PRO-23-610-50	21.5 cm (8 ½"), Fig. 00000



Billeau Ear Loop

Catalog #	Size
PRO-23-660-01	16 cm (6 ¼")
PRO-23-660-02	16 cm (6 ¼")
PRO-23-660-03	16 cm (6 ¼")



Weber-Loch Ear Loop

Catalog #	Size
PRO-23-650-01	16.5 cm (6 ¼")



Lucae Ear Hook

Catalog #	Size, Profile
PRO-23-673-01	14 cm (5 ½"), Small
PRO-23-673-02	14 cm (5 ½"), Medium
PRO-23-673-03	14 cm (5 ½"), Large

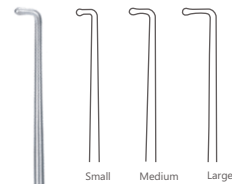

Hartmann Ear Hook
Sharp

Catalog #	Size
PRO-23-671-16	16 cm (6 ¼")





Wagener Ear Hook

Catalog #	Size, Point Size, Profile
PRO-23-675-01	14 cm (5 1/2"), 2 mm, Fig. 1
PRO-23-675-02	14 cm (5 1/2"), 2.5 mm, Fig. 2
PRO-23-675-03	14 cm (5 1/2"), 3 mm, Fig. 3
PRO-23-675-04	14 cm (5 1/2"), 3.5 mm, Fig. 4
PRO-23-675-05	14 cm (5 1/2"), 4 mm, Fig. 5

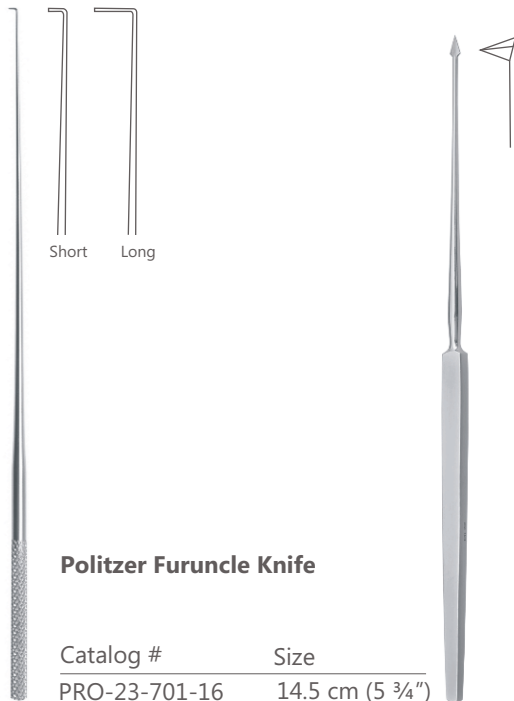

Day Ear Hook

Catalog #	Size, Profile
PRO-23-677-01	17 cm (6 3/4"), Long
PRO-23-677-02	17 cm (6 3/4"), Short

Politzer Furuncle Knife

Catalog #	Size
PRO-23-701-16	14.5 cm (5 3/4")



Politzer Tympanum Needle

Catalog #	Size
PRO-23-704-16	17.5 cm (7")



Catalog #	Size
PRO-23-707-16	15.5 cm (6")



Politzer Tympanum Needle
Needle Horizontal

Catalog #	Size
PRO-23-709-16	16 cm (6 1/4")



Lucae Tympanum Needle

Catalog #	Size
PRO-23-711-16	17.5 cm (7")



Lucae Tympanum Needle

Catalog #	Size
PRO-23-713-16	17.5 cm (7")



Moldnehauser Foreign Body Lever

Catalog #	Size
PRO-23-721-16	15.5 cm (6")



Zaufal Foreign Body Lever

Catalog #	Size
PRO-23-723-16	15 cm (6")



Lempert Periosteal Elevator

Catalog #	Size, Width
PRO-23-727-20	20.5 cm (8"), 6 mm



Lempert Periosteal Elevator

Lempert Periosteal Elevator

Catalog #	Size, Width
PRO-23-729-18	18 cm (7"), 6 mm

Catalog #	Size, Width
PRO-23-731-02	17 cm (6 ¾"), 2 mm
PRO-23-731-03	17 cm (6 ¾"), 3 mm
PRO-23-731-04	17 cm (6 ¾"), 4 mm
PRO-23-731-05	17 cm (6 ¾"), 5 mm

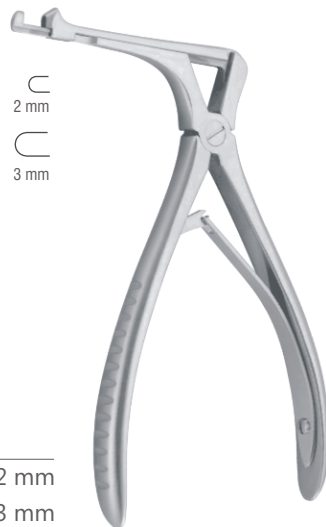

Citelli Mastoid Rongeur

Catalog #	Size, Bite Size
PRO-23-751-02	17 cm (6 ¾"), 2 mm
PRO-23-751-03	17 cm (6 ¾"), 3 mm

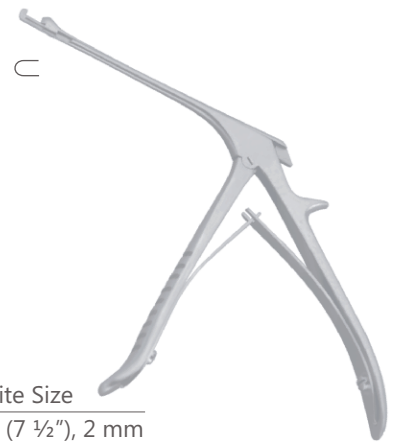

Beyer Mastoid Rongeur

Catalog #	Size, Bite Size
PRO-23-755-19	19 cm (7 ½"), 2 mm



Beyer Mastoid Rongeur

Catalog #	Size, Bite Size
PRO-23-759-14	14 cm (5 1/2"), 1 mm



Ear Syringe Complete
With Protection Disk and 2 Tips

Catalog #	Capacity
PRO-23-800-00	50 ml
PRO-23-802-00	100 ml