



**PRECISION**<sup>™</sup>  
SURGICAL WORKS

## RHINOLOGY INSTRUMENTS

Rhinologie  
Rinología  
Rhinologie  
Rinologia





**Thudichum Nasal Specula**

Set of 3

Catalog #	Size
PRO-25-011-10	Standard

**Thudichum Nasal Specula**

Set of 4

Catalog #	Size
PRO-25-011-20	Standard

**Thudichum Nasal Speculum**



Catalog #	Blade Size, Profile
PRO-25-013-01	12 mm , Fig. 1
PRO-25-013-02	14 mm , Fig. 2
PRO-25-013-03	16.5 mm , Fig. 3
PRO-25-013-04	18.5 mm , Fig. 4
PRO-25-013-05	20.5 mm, Fig. 5
PRO-25-013-06	22 mm, Fig. 6
PRO-25-013-07	23 mm, Fig. 7

**Voltolini Nasal Speculum**



Catalog #	Size, Profile
PRO-25-017-01	Standard, Fig. 1
PRO-25-017-02	Standard, Fig. 2
PRO-25-017-03	Standard, Fig. 3

**Mod. Vienna Nasal Specula**  
Set of 3

Catalog #	Size
PRO-25-021-10	Standard



**Mod. Vienna Nasal Speculum**



Catalog #	Blade Length, Profile
PRO-25-023-01	27 mm, Fig. 1
PRO-25-023-02	31 mm, Fig. 2
PRO-25-023-03	35 mm, Fig. 3



**Hartmann-Halle Nasal Speculum**

Set of 3

Catalog #	Size, Blade Length, Profile
PRO-25-033-01	15.5 cm (6") , 27 mm, Fig. 1
PRO-25-033-02	15.5 cm (6") , 31 mm, Fig. 2
PRO-25-033-03	15.5 cm (6") , 35 mm, Fig. 3



**Martin Nasal Specula**

Catalog #	Size, Blade Length
PRO-25-035-13	13 cm (5") , 17 mm

**Martin Nasal Specula  
Bent Sidewards**

Catalog #	Size, Blade Length
PRO-25-037-13	12.5 cm (5") , 17 mm





**Tieck-Halle Nasal Specula**

Catalog #	Size, Blade Length
PRO-25-041-13	13 cm (5") , 16 mm

**Killian Nasal Speculum**

Catalog #	Size, Blade Length, Profile
PRO-25-053-01	13 cm (5"), 35 mm, Fig. 1
PRO-25-053-02	13 cm (5"), 50 mm, Fig. 2
PRO-25-053-03	13 cm (5"), 75 mm, Fig. 3
PRO-25-053-04	13 cm (5"), 85 mm, Fig. 4



**Cottle Nasal Speculum**

Catalog #	Size, Blade Length, Profile
PRO-25-063-01	13.5 cm (5 ¼"), 35 mm, Fig. 1
PRO-25-063-02	13.5 cm (5 ¼"), 50 mm, Fig. 2
PRO-25-063-03	13.5 cm (5 ¼"), 75 mm, Fig. 3
PRO-25-063-04	14.5 cm (5 ¾"), 85 mm, Fig. 4



**Cottle Nasal Speculum**  
With Screw Fixation

Catalog #	Size, Blade Length, Profile
PRO-25-067-01	13.5 cm (5 ¼"), 35 mm, Fig. 1
PRO-25-067-02	13.5 cm (5 ¼"), 50 mm, Fig. 2
PRO-25-067-03	13.5 cm (5 ¼"), 75 mm, Fig. 3
PRO-25-067-04	14.5 cm (5 ¾"), 85 mm, Fig. 4



**Cottle Nasal Specula**  
Black

Catalog #	Size, Blade Length
PRO-25-073-45	13.5 cm (5 ¼"), 45 mm
PRO-25-073-75	14 cm (5 ½"), 75 mm



**Krause Polypus Snare**

Catalog #	Size, Shaft Diameter
PRO-25-091-26	26 cm (10 ¼"), Ø 3.0 mm



**Krause-Voss Polypus Snare**

Catalog #	Size, Shaft Diameter
PRO-25-093-26	26 cm (10 ¼"), Ø 3.0 mm



**Lange-Wilde Polypus Snare**

Catalog #	Size
PRO-25-095-24	24 cm (9 ½")

**Polypus Wire**  
Bundle with 12 Pieces

Catalog #	Size
PRO-25-097-12	10.5 cm (4"), Ø 0.3





**Troeltsch Nasal Tampon Forcep**

Catalog #	Size
PRO-25-101-15	14.5 cm (5 ¾")



**Troeltsch Nasal Tampon Forcep**

Catalog #	Size
PRO-25-103-18	18 cm (7")



**Gruenwald (Jansen) Nasal Tampon Forcep**

Catalog #	Size
PRO-25-105-21	21.5 cm (8 ½")



**Nasal Tampon Forcep  
Smooth Jaws**

Catalog #	Size
PRO-25-107-16	16 cm (6 ¼")





**Nasal Tampon Forcep**  
1 x 2 Teeth

Catalog #	Size
PRO-25-109-16	16 cm (6 ¼")



**Nasal Tampon Forcep**  
Smooth Jaws

Catalog #	Size
PRO-25-111-18	18.5 cm (7 ¼")



**Nasal Tampon Forcep**  
1 x 2 Teeth

Catalog #	Size
PRO-25-113-20	20 cm (8")

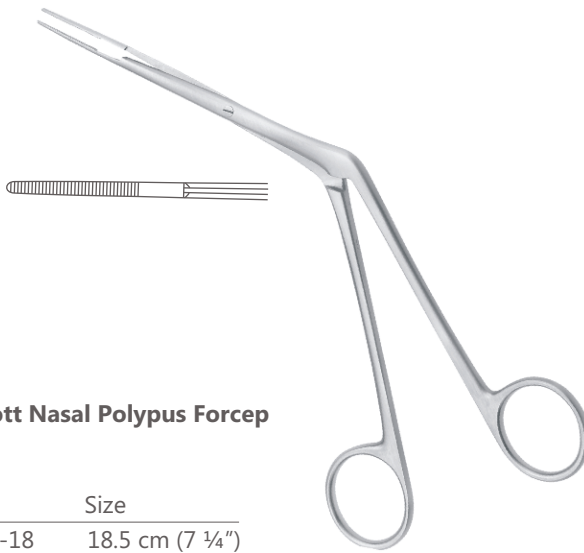

**Westmoacott Nasal Polypus Forcep**

Catalog #	Size
PRO-25-121-18	18.5 cm (7 ¼")

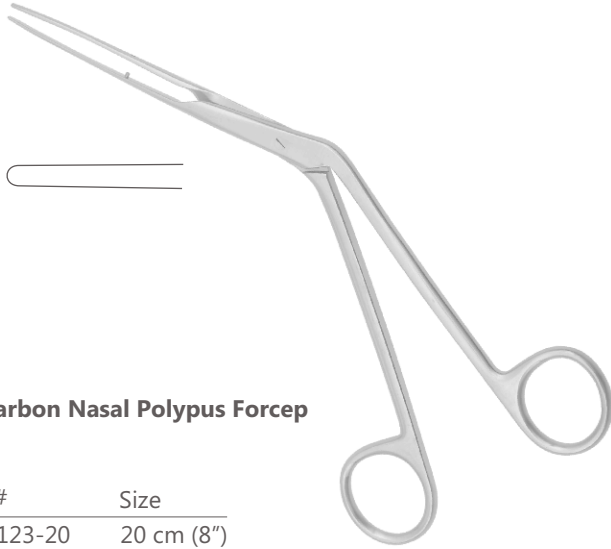

**Lubet-Barbon Nasal Polypus Forcep**

Catalog #	Size
PRO-25-123-20	20 cm (8")

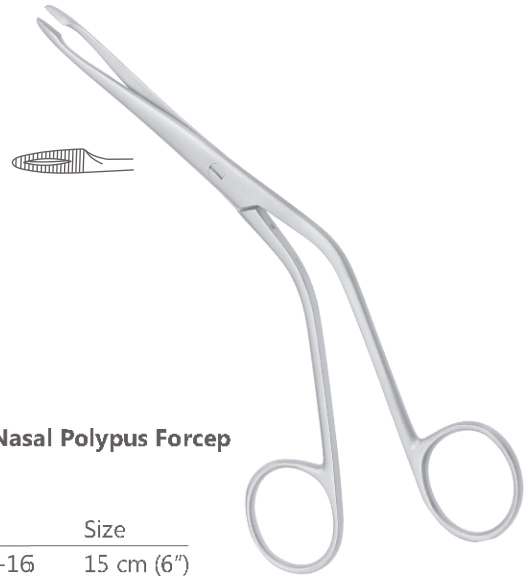

**Hartmann Nasal Polypus Forcep**

Catalog #	Size
PRO-25-127-16	15 cm (6")

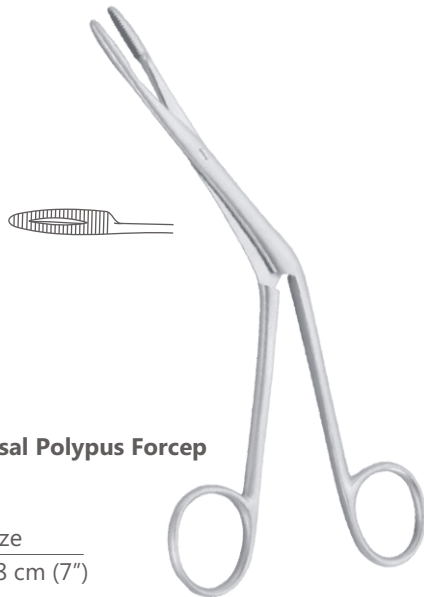

**Heymann-Knight Nasal Polypus Forcep**

Catalog #	Size
PRO-25-129-18	18 cm (7")

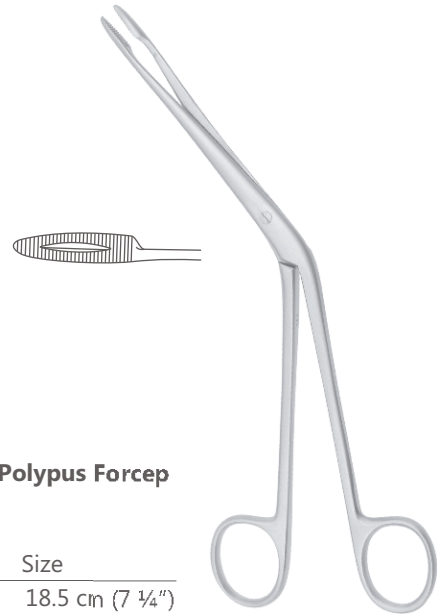

**Hartmann Nasal Polypus Forcep**

Catalog #	Size
PRO-25-131-20	18.5 cm (7 ¼")

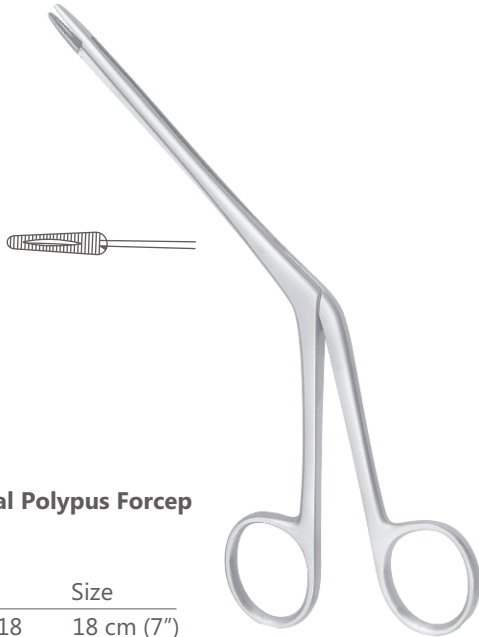

**Littauer Nasal Polypus Forcep**

Catalog #	Size
PRO-25-133-18	18 cm (7")

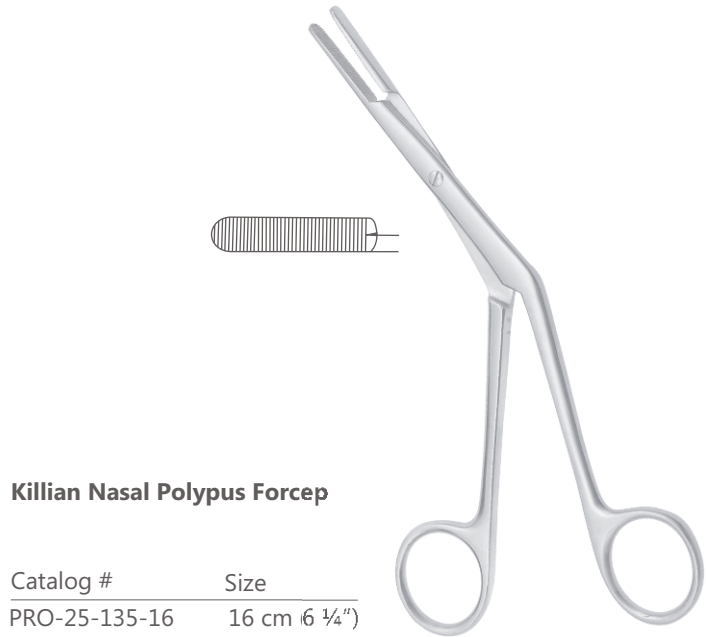

**Killian Nasal Polypus Forcep**

Catalog #	Size
PRO-25-135-16	16 cm (6 ¼")



**Heymann Septum Forcep**

Catalog #	Size, Profile
PRO-25-161-01	18 cm (7"), Fig. 1
PRO-25-161-02	18 cm (7"), Fig. 2
PRO-25-161-03	18 cm (7"), Fig. 3

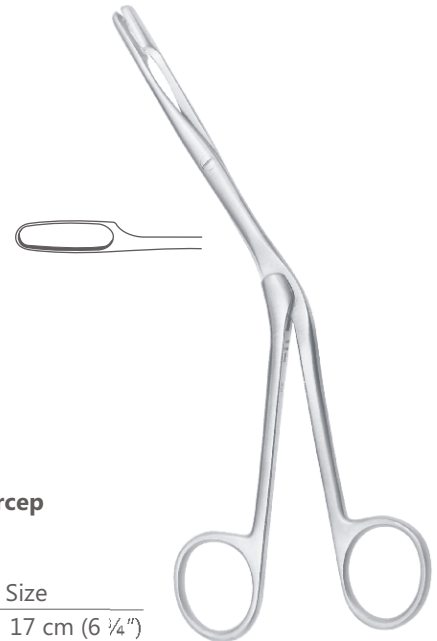

**Knight Septum Forcep**

Catalog #	Size
PRO-25-165-17	17 cm (6 ¾")

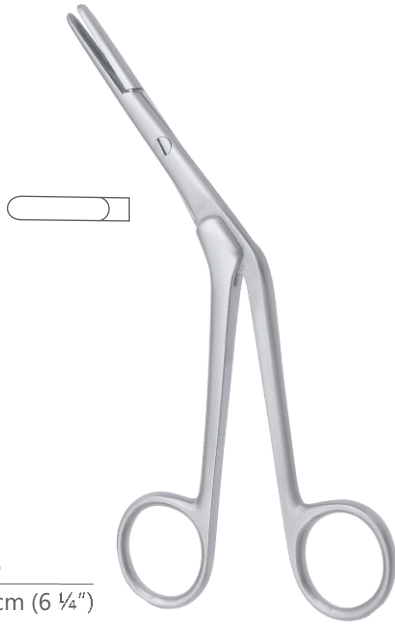

**Craig Septum Forcep**

Catalog #	Size
PRO-25-167-16	16 cm (6 ¼")

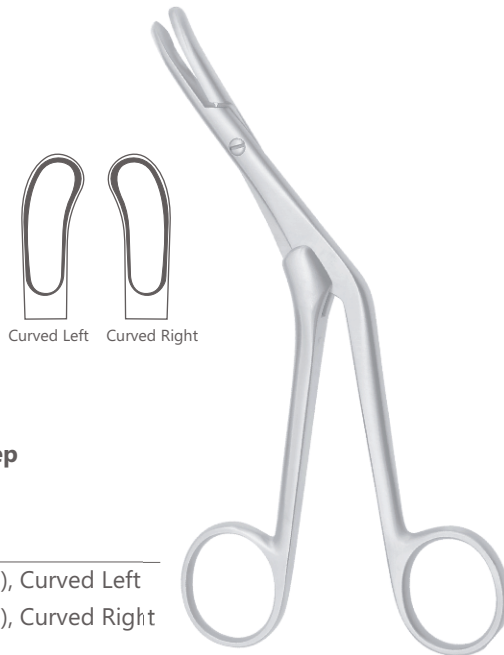

**Craig-Dominick Ethmoid Forcep**

Catalog #	Size, Profile
PRO-25-169-01	16 cm (6 ¼"), Curved Left
PRO-25-169-02	16 cm (6 ¼"), Curved Right

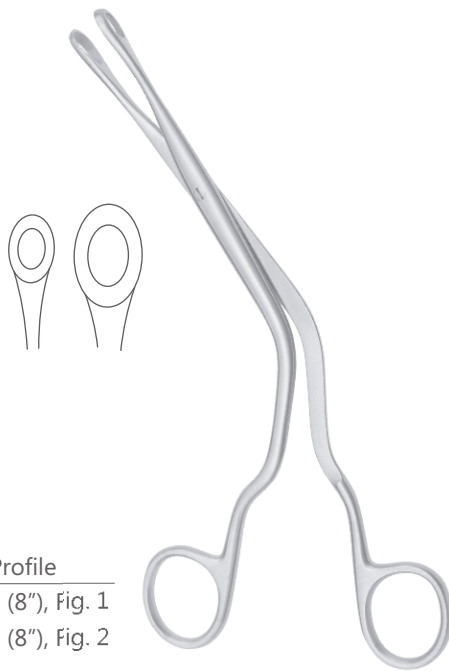

**Luc Ethmoid Forcep**  
Fenestrated

Catalog #	Size, Profile
PRO-25-171-01	20 cm (8"), Fig. 1
PRO-25-171-02	20 cm (8"), Fig. 2

**Luce Thmoid Forcep**

Catalog #	Size, Profile
PRO-25-173-01	20 cm (8"), fig. 1
PRO-25-173-02	20 cm (8"), fig. 2

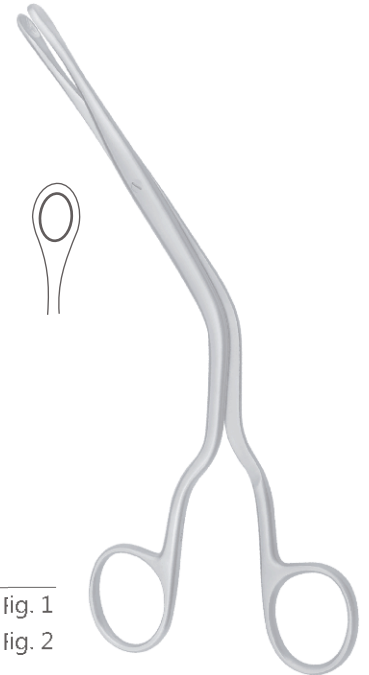

**Bruenings Ethmoid Forcep**

Catalog #	Size, Profile
PRO-25-175-01	16.5 cm (6 1/2"), Fig. 1
PRO-25-175-04	16.5 cm (6 1/2"), Fig. 2
PRO-25-175-05	16.5 cm (6 1/2"), Fig. 3
PRO-25-175-06	16.5 cm (6 1/2"), Fig. 4

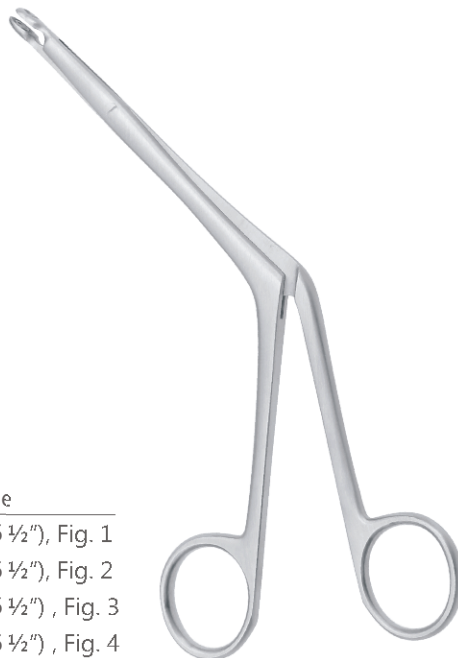

**Takahashi Ethmoid Forcep**  
Straight

Catalog #	Size
PRO-25-181-12	12 cm (4 3/4")





**Takahashi Ethmoid Forcep**  
Bent Upwards

Catalog #	Size
PRO-25-183-12	12 cm (4 ¾")



**Waston-Williams Ethmoid Forcep**

Catalog #	Size
PRO-25-191-19	12 cm (4 ¾")



**Waston-Williams Ethmoid Forcep**

Catalog #	Size
PRO-25-193-19	12 cm (4 ¾")

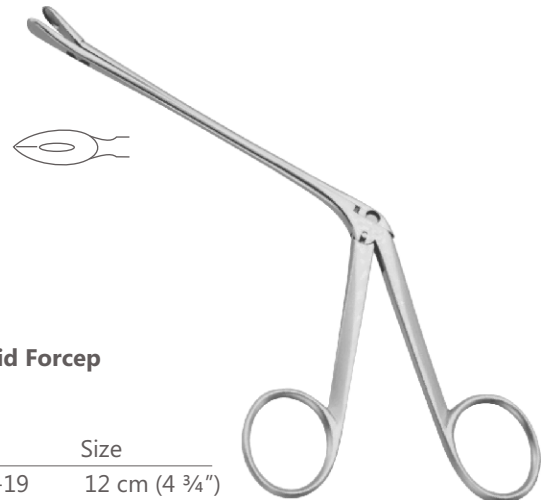

**Weil Ethmoid Forcep**  
With Neck

Catalog #	Size
PRO-25-195-19	12 cm (4 ¾")



**Weil-Blakesley Nasal Cutting Forcep**  
Straight

Catalog #	Size, Bite Size, Profile
PRO-25-201-01	12 cm (4 ¾"), 3.0 mm, Fig. 1
PRO-25-201-02	12 cm (4 ¾"), 3.5 mm, Fig. 2
PRO-25-201-03	12 cm (4 ¾"), 4.5 mm, Fig. 3
PRO-25-201-04	12 cm (4 ¾"), 5.0 mm, Fig. 4
PRO-25-201-05	12 cm (4 ¾"), 5.5 mm, Fig. 5

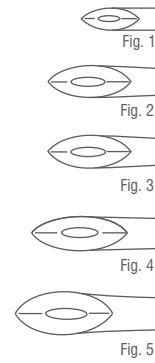

**Weil-Blakesley Nasal Cutting Forcep**  
Angled 45°

Catalog #	Size, Bite Size, Profile
PRO-25-203-01	12 cm (4 ¾"), 3.0 mm, Fig. 1
PRO-25-203-02	12 cm (4 ¾"), 3.5 mm, Fig. 2
PRO-25-203-03	12 cm (4 ¾"), 4.5 mm, Fig. 3
PRO-25-203-04	12 cm (4 ¾"), 5.0 mm, Fig. 4



**Weil-Blakesley Nasal Cutting Forcep**  
Angled 90°

Catalog #	Size, Bite Size, Profile
PRO-25-205-01	12 cm (4 ¾"), 3.0 mm, Fig. 1
PRO-25-205-02	12 cm (4 ¾"), 3.0 mm, Fig. 2
PRO-25-205-03	12 cm (4 ¾"), 4.5 mm, Fig. 3
PRO-25-205-04	12 cm (4 ¾"), 5.0 mm, Fig. 4



**Strucken Nasal Cutting Forcep**

Catalog #	Size, Bite Size, Profile
PRO-25-231-01	12 cm (4 ¾"), 0.9 mm, Fig. 1
PRO-25-231-02	12 cm (4 ¾"), 1.2 mm, Fig. 2



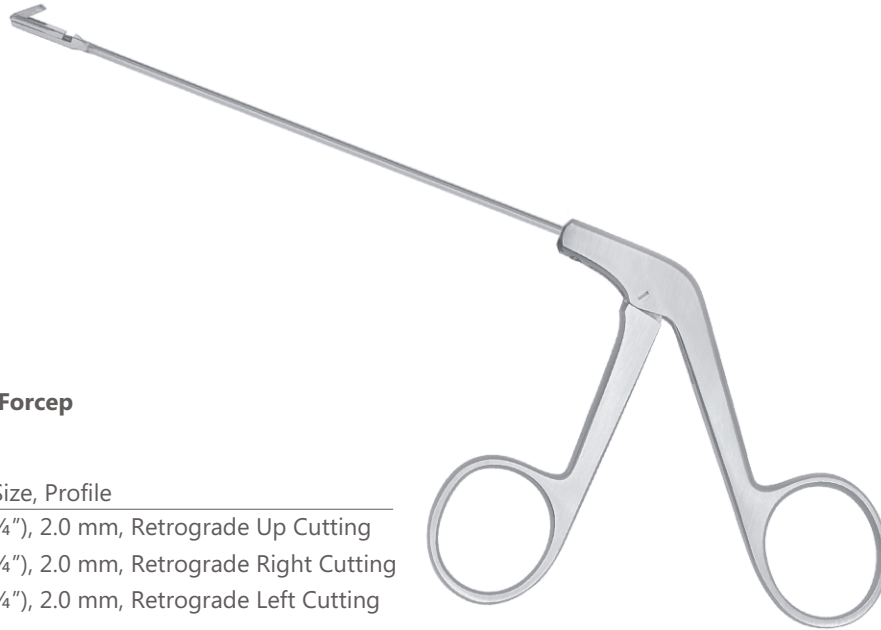

**Stammberger Nasal Cutting Forcep**

Catalog #	Size, Bite Size, Profile
PRO-25-235-01	12 cm (4 ¾"), 2.0 mm, Retrograde Up Cutting
PRO-25-235-02	12 cm (4 ¾"), 2.0 mm, Retrograde Right Cutting
PRO-25-235-03	12 cm (4 ¾"), 2.0 mm, Retrograde Left Cutting



**Hartmann Nasal Cutting Forcep (Conchotome)**

Catalog #	Size, Diameter, Profile
PRO-25-241-01	12 cm (4 ¾"), Ø 5.0 mm, Fig. 1
PRO-25-241-02	12 cm (4 ¾"), Ø 7.0 mm, Fig. 2
PRO-25-241-03	12 cm (4 ¾"), Ø 9.0 mm, Fig. 3
PRO-25-241-04	12 cm (4 ¾"), Ø 11.0 mm, Fig. 4



**Schmeden Nasal Cutting Forcep**

Catalog #	Size, Diameter
PRO-25-245-12	12 cm (4 ¾"), Ø 8.0 mm



**Jensen-Middelton Septum Forcep  
Through Cutting Jaws**

Catalog #	Size
PRO-25-281-19	19 cm (7 ½")

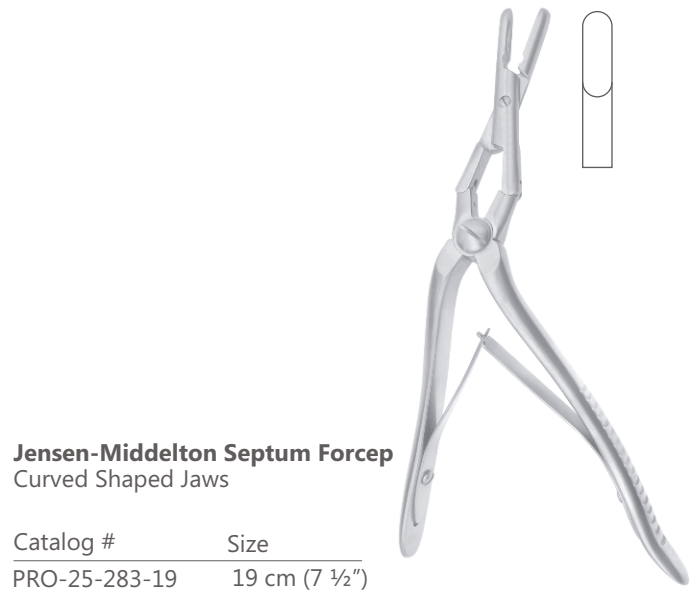

**Jensen-Middelton Septum Forcep  
Curved Shaped Jaws**

Catalog #	Size
PRO-25-283-19	19 cm (7 ½")



**UltraGrip™ TC Rubin Septum Forcep**

Catalog #	Size
PRO-25-291-21	21 cm (8 ¼")

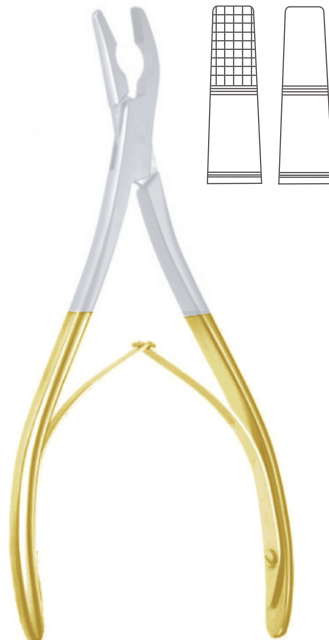

**UltraGrip™ TC Lower Lateral Morseliser**

Catalog #	Size
PRO-25-293-21	19 cm (7 ½")

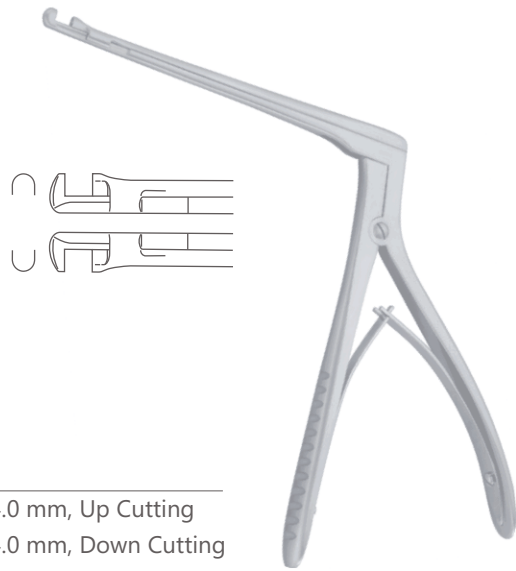

**Hajek Sphenoid Punch**

Catalog #	Size, Bite Size, Profile
PRO-25-301-01	14 cm (5 1/2"), 4.0 mm x 4.0 mm, Up Cutting
PRO-25-301-02	14 cm (5 1/2"), 4.0 mm x 4.0 mm, Down Cutting

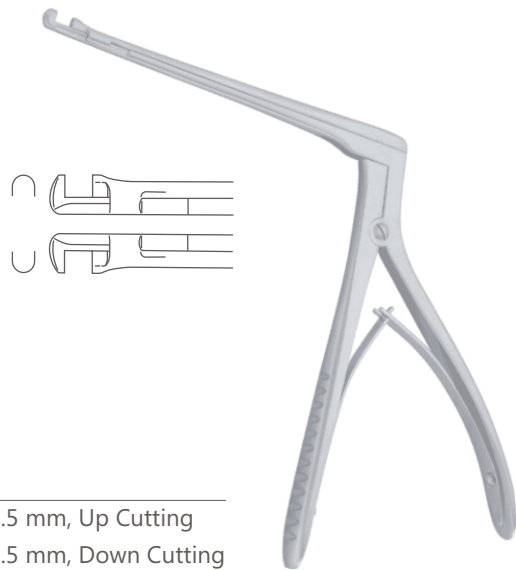

**Hajek-Kofler Sphenoid Punch**

Catalog #	Size, Bite Size, Profile
PRO-25-303-01	14 cm (5 1/2"), 3.5 mm x 3.5 mm, Up Cutting
PRO-25-303-02	14 cm (5 1/2"), 3.5 mm x 3.5 mm, Down Cutting



**Kerrison Sphenoid Punch**  
Up Cutting

Catalog #	Size, Diameter
PRO-25-305-03	14 cm (5 ½"), Ø 3.0 mm x 3.0 mm
PRO-25-305-04	9 cm (3 ½"), Ø 4.0 mm x 4.0 mm
PRO-25-305-05	9 cm (3 ½"), Ø 5.0 mm x 5.0 mm
PRO-25-305-06	9 cm (3 ½"), Ø 6.0 mm x 6.0 mm

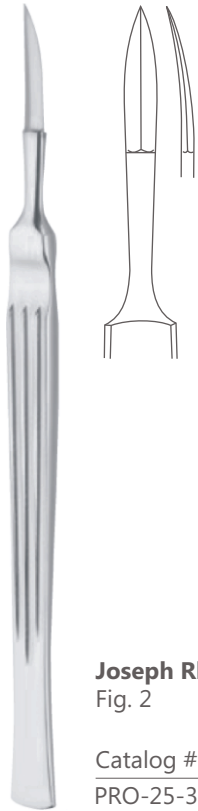

**Joseph Rhinoplastic Knife**  
Fig. 2

Catalog #	Size
PRO-25-351-15	15 cm (6")

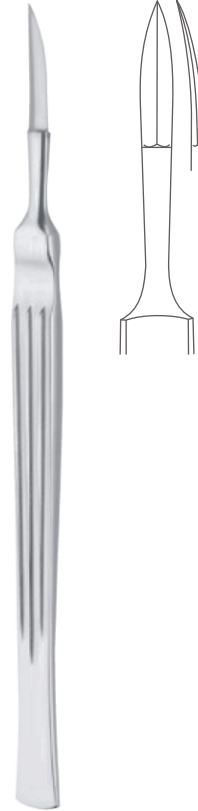

**Joseph Rhinoplastic Knife**  
Fig. 1

Catalog #	Size
PRO-25-350-15	15 cm (6")

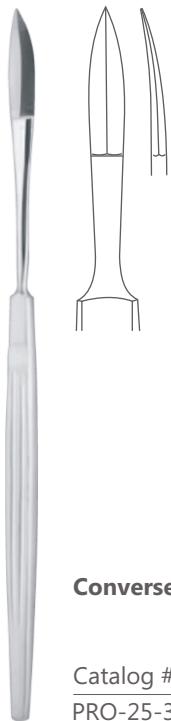

**Fomon Rhinoplastic Knife**

Catalog #	Size
PRO-25-355-15	16.5 cm (6 1/2")



**Converse Rhinoplastic Knife**

Catalog #	Size
PRO-25-361-16	16 cm (6 1/4")



**Joseph Rhinoplastic Knife**

Catalog #	Size
PRO-25-365-15	15 cm (6")

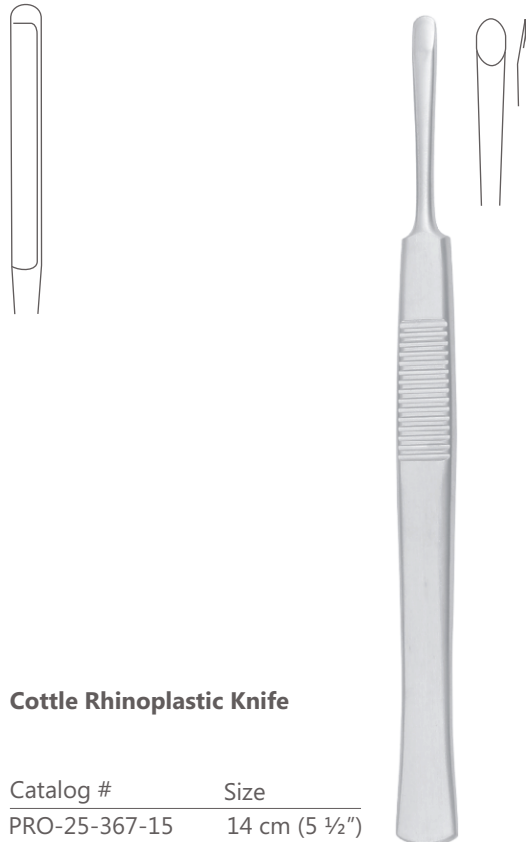

**Cottle Rhinoplastic Knife**

Catalog #	Size
PRO-25-367-15	14 cm (5 ½")



**Freer Mucosa Knife**

Catalog #	Size
PRO-25-369-15	16.5 cm (6 ½")



**Freer Septum Knife**

Catalog #	Size
PRO-25-371-01	18 cm (7")
PRO-25-371-02	18 cm (7")



**Freer Septum Knife**

Catalog #	Size
PRO-25-373-01	18 cm (7")
PRO-25-373-02	19 cm (7 ½")



**Ballanger Swivel Knife**  
Straight

Catalog #	Size, Cutting Edge Size
PRO-25-380-03	21 cm (8 ¼"), 3.0 mm
PRO-25-380-04	21 cm (8 ¼"), 4.0 mm
PRO-25-380-05	21 cm (8 ¼"), 5.0 mm



**Ballanger Swivel Knife**  
Bayonet Shaped

Catalog #	Size, Cutting Edge Size
PRO-25-381-03	20 cm (8"), 3.0 mm
PRO-25-381-04	20 cm (8"), 4.0 mm
PRO-25-381-05	20 cm (8"), 5.0 mm





**McKenty Septum Elevator**

Catalog #	Size, Blade Size
PRO-25-451-04	15 cm (6"), 4.0 mm
PRO-25-451-05	15 cm (6"), 5.0 mm

**Halle Septum Elevator**

Catalog #	Size, Blade Size
PRO-25-455-16	16 cm (6 1/4"), 3.5 mm



**Joseph Septum Elevator**

Catalog #	Size, Blade Size
PRO-25-461-16	16 cm (6 1/4"), 4.0 mm



**Freer Septum Elevator**

Catalog #	Size, Blade Size, Profile
PRO-25-471-19	19 cm (7 1/2"), 5.0 mm, Sharp
PRO-25-473-19	19 cm (7 1/2"), 6.0 mm, Blunt





**Freer Septum Elevator**  
Double Ended, Sharpe/Blunt

Catalog #	Size, Blade Size 1, Blade Size 2
PRO-25-475-18	18.5 cm (7 ¼"), 5.0 mm, 5.0 mm

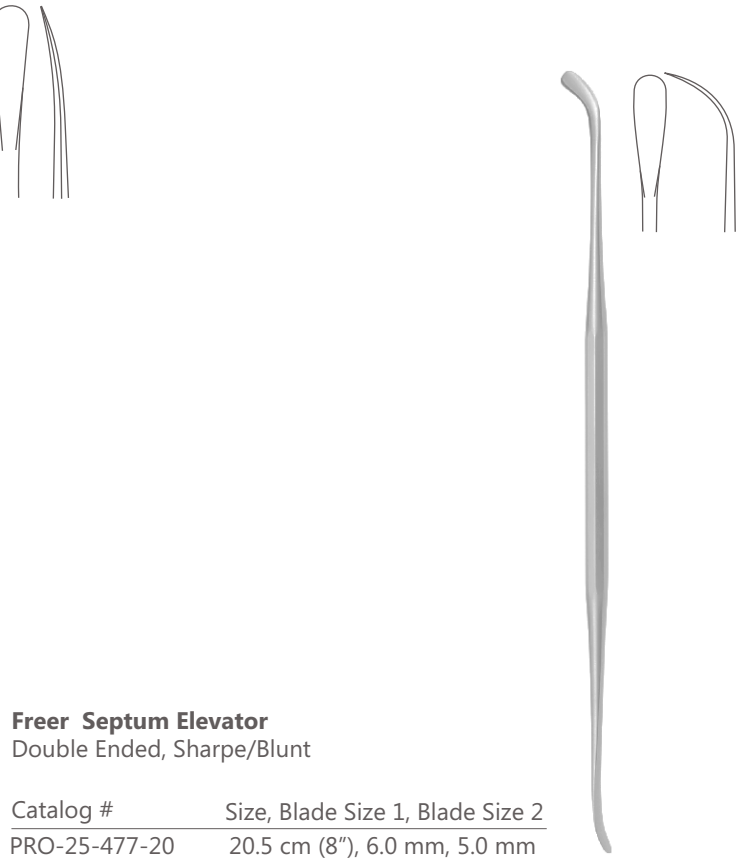

**Freer Septum Elevator**  
Double Ended, Sharpe/Blunt

Catalog #	Size, Blade Size 1, Blade Size 2
PRO-25-477-20	20.5 cm (8"), 6.0 mm, 5.0 mm



**McKenty Septum Elevator**

Catalog #	Size, Blade Size 1, Blade Size 2
PRO-25-479-20	20.5 cm (8"), 4.0 mm, 4.0 mm



**Ballanger-Hajek Septum Elevator**

Catalog #	Size, Blade Size 1, Blade Size 2
PRO-25-482-19	19 cm (7 ½"), 6.0 mm, 6.0 mm

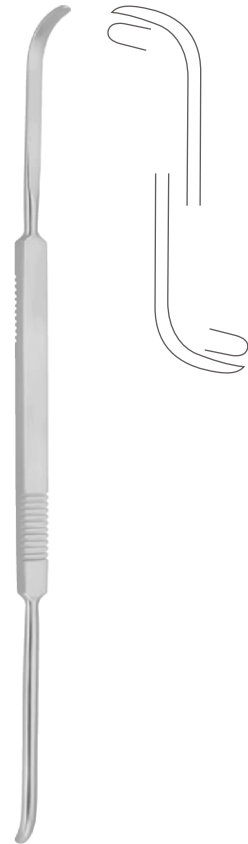

**Cottle Septum Elevator**

Catalog #	Size, Blade Size 1, Blade Size 2
PRO-25-501-23	23.5 cm (9 1/4"), 5.0 mm , 5.0 mm

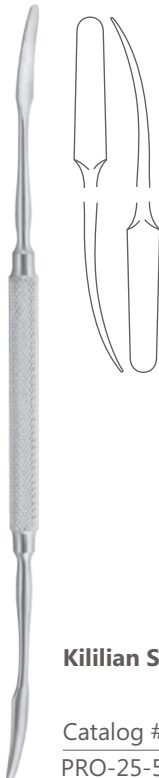

**Kilian Septum Elevator**

Catalog #	Size, Blade Size 1, Blade Size 2
PRO-25-503-18	18 cm (7"), 4.0 mm , 4.0 mm

**Kilian Septum Elevator**

Catalog #	Size, Blade Size 1, Blade Size 2
PRO-25-505-23	23 cm (9"), 4.5 mm , 4.5 mm

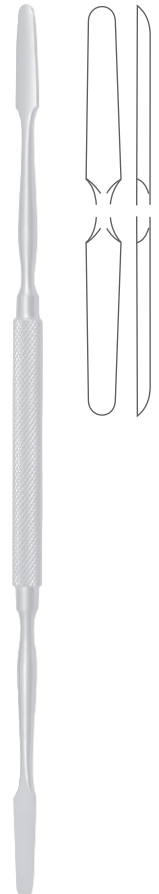

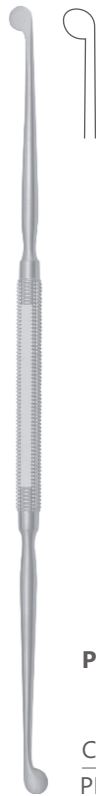

**Pierce Septum Elevator**

Catalog #	Size, Blade Size 1, Blade Size 2
PRO-25-507-21	21.5 cm (8 ½"), 4.0 mm , 4.0 mm

**Pennington Septum Elevator**

Catalog #	Size, Blade Size 1, Blade Size 2
PRO-25-509-21	21.5 cm (8 ½"), 4.0 mm , 4.0 mm

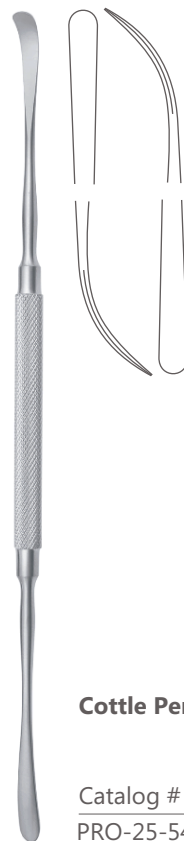
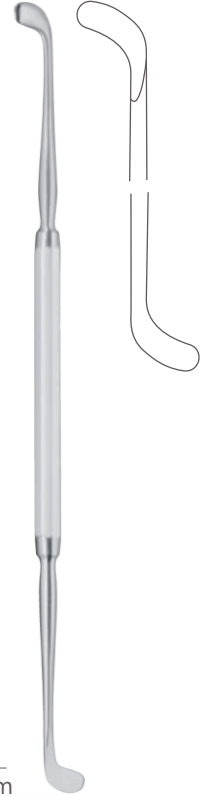

**Roger Periosteal Elevator**

Catalog #	Size, Blade Size 1, Blade Size 2
PRO-25-511-19	19.5 cm (7 ¾"), 4.0 mm , 4.0 mm

**Cottle Periosteal Elevator**

Catalog #	Size, Blade Size 1, Blade Size 2
PRO-25-541-22	23 cm (9"), 3.3 mm , 3.7 mm



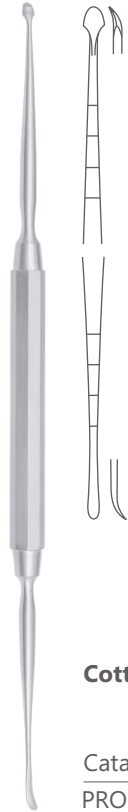

**Masing Periosteal Elevator**

Catalog #	Size, Blade Size 1, Blade Size 2
PRO-25-543-21	19.5 cm (7 3/4"), 3.0 mm , 2.0 mm

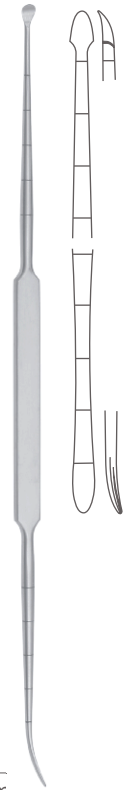

**Cottle Periosteal Elevator**

Catalog #	Size, Blade Size 1, Blade Size 2
PRO-25-545-21	19.5 cm (7 3/4"), 4.5 mm , 4.5 mm



**Howarth Periosteal Elevator**

Catalog #	Size
PRO-25-547-21	21.5 cm (8 1/2")



**Joseph Periosteal Elevator**

Catalog #	Size, Blade Width
PRO-25-551-16	18 cm (7"), 6.0 mm



**Freer Septum Chisel**  
Straight

Catalog #	Size, Blade Width
PRO-25-600-16	16.5 cm (6 1/2"), 4.0 mm



**Freer Septum Chisel**  
Curved

Catalog #	Size, Blade Width
PRO-25-601-16	16.5 cm (6 1/2"), 4.0 mm



**West Septum Chisel**

Catalog #	Size
PRO-25-604-16	16 cm (6 1/4")



**West Septum Gouge**

Catalog #	Size
PRO-25-605-16	16 cm (6 1/4")



**Freer Septum Gouge**

Catalog #	Size, Blade Width
PRO-25-608-16	15 cm (6"), 6.0 mm

**Ballenger Septum Gouge**

Catalog #	Size, Blade Width
PRO-25-610-02	15 cm (6"), 2.0 mm
PRO-25-610-04	15 cm (6"), 4.0 mm
PRO-25-610-06	15 cm (6"), 6.0 mm
PRO-25-610-08	15 cm (6"), 8.0 mm

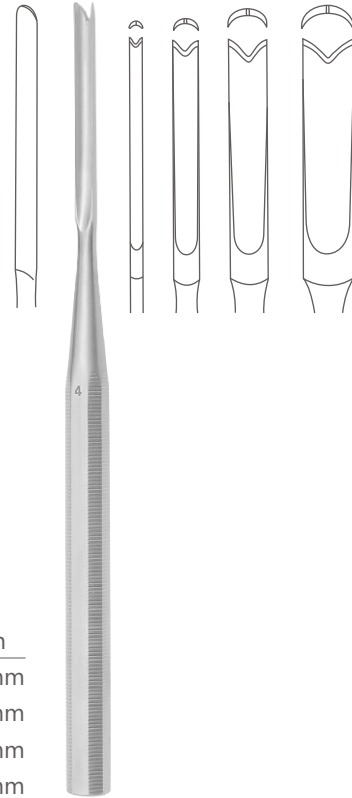

**Killian Septum Gouge**  
Bayonet Shaped

Catalog #	Size, Blade Width
PRO-25-613-16	16 cm (6 ¼"), 8.0 mm

**Killian-Claus Septum Gouge**  
Bayonet Shaped

Catalog #	Size, Blade Width
PRO-25-615-16	16 cm (6 ¼"), 5.0 mm





**Cottle Osteotome**  
Straight

Catalog #	Size, Blade Width
PRO-25-620-04	18.5 cm (7 1/4"), 4.0 mm
PRO-25-620-07	18.5 cm (7 1/4"), 7.0 mm
PRO-25-620-09	18.5 cm (7 1/4"), 9.0 mm
PRO-25-620-12	18.5 cm (7 1/4"), 12.0 mm



**Cottle Osteotome**  
Curved

Catalog #	Size, Blade Width
PRO-25-621-06	18.5 cm (7 1/4"), 6.0 mm

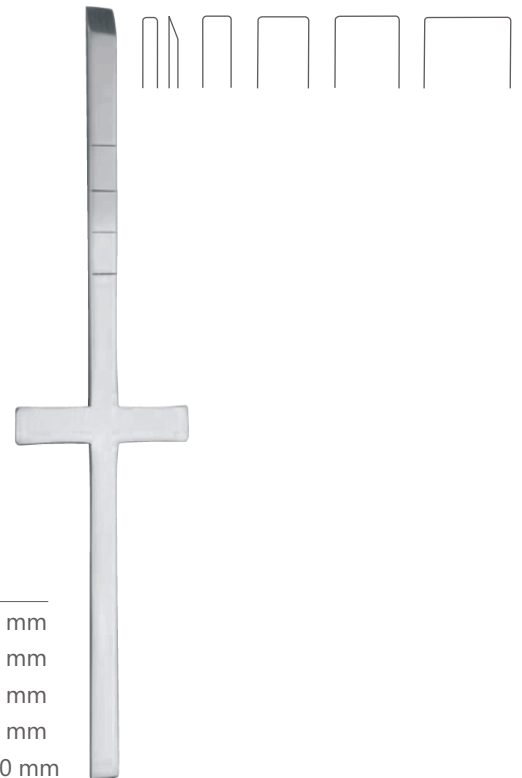

**Cottle Chisel**  
Straight , Cross Handle

Catalog #	Size, Blade Width
PRO-25-626-02	18.5 cm (7 1/4"), 2.0 mm
PRO-25-626-04	18.5 cm (7 1/4"), 4.0 mm
PRO-25-626-07	18.5 cm (7 1/4"), 7.0 mm
PRO-25-626-09	18.5 cm (7 1/4"), 9.0 mm
PRO-25-626-12	18.5 cm (7 1/4"), 12.0 mm



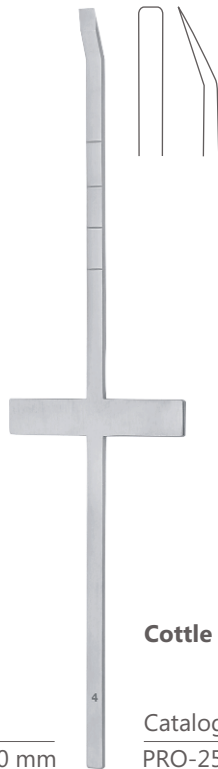

**Cottle Chisel**  
Curved, Cross Handle

Catalog #	Size, Blade Width
PRO-25-627-06	18.5 cm (7 ¼"), 6.0 mm

**Cottle Osteotome**

Catalog #	Size, Blade Width
PRO-25-630-16	18.5 cm (7 ¼"), 16.0 mm



**Cottle Osteotome**  
Cross Handle

Catalog #	Size, Blade Width
PRO-25-632-16	18.5 cm (7 ¼"), 16.0 mm

**Rubin Osteotome**

Catalog #	Size, Blade Width
PRO-25-636-10	18.5 cm (7 ¼"), 10.0 mm
PRO-25-636-12	18.5 cm (7 ¼"), 12.0 mm
PRO-25-636-14	18.5 cm (7 ¼"), 14.0 mm

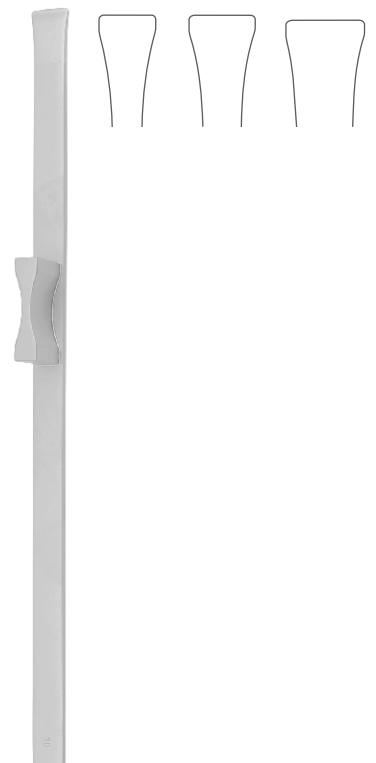



**Walter Chisel**

Catalog #	Size, Blade Width
PRO-25-640-03	9 cm (7 1/2"), 3.0 mm
PRO-25-640-04	9 cm (7 1/2"), 4.5 mm

**Walter Osteotome**

Catalog #	Size, Blade Width
PRO-25-642-03	19 cm (7 1/2"), 3.0 mm
PRO-25-642-04	19 cm (7 1/2"), 4.0 mm
PRO-25-642-07	19 cm (7 1/2"), 7.0 mm
PRO-25-642-09	19 cm (7 1/2"), 9.0 mm
PRO-25-642-12	19 cm (7 1/2"), 12.0 mm



**Fomon Chisel**

Catalog #	Size, Blade Width
PRO-25-648-04	16 cm (6 1/4"), 4.0 mm
PRO-25-648-05	16 cm (6 1/4"), 5.0 mm
PRO-25-648-06	16 cm (6 1/4"), 6.0 mm
PRO-25-648-07	16 cm (6 1/4"), 7.0 mm

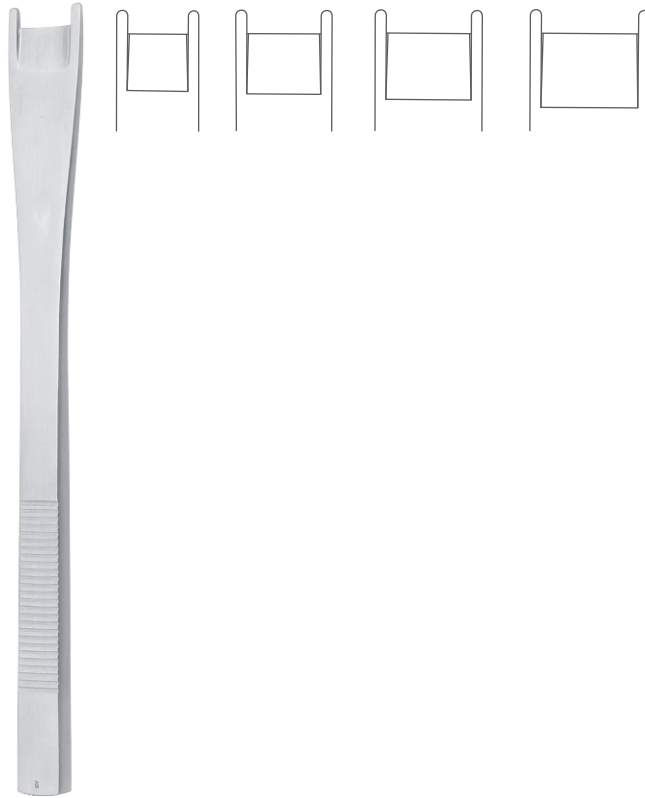

**Cinelli Osteotome**

Catalog #	Size, Blade Width
PRO-25-650-10	16 cm (6 ¼"), 10.0 mm
PRO-25-650-12	16 cm (6 ¼"), 12.0 mm
PRO-25-650-14	16 cm (6 ¼"), 14.0 mm
PRO-25-650-16	16 cm (6 ¼"), 16.0 mm

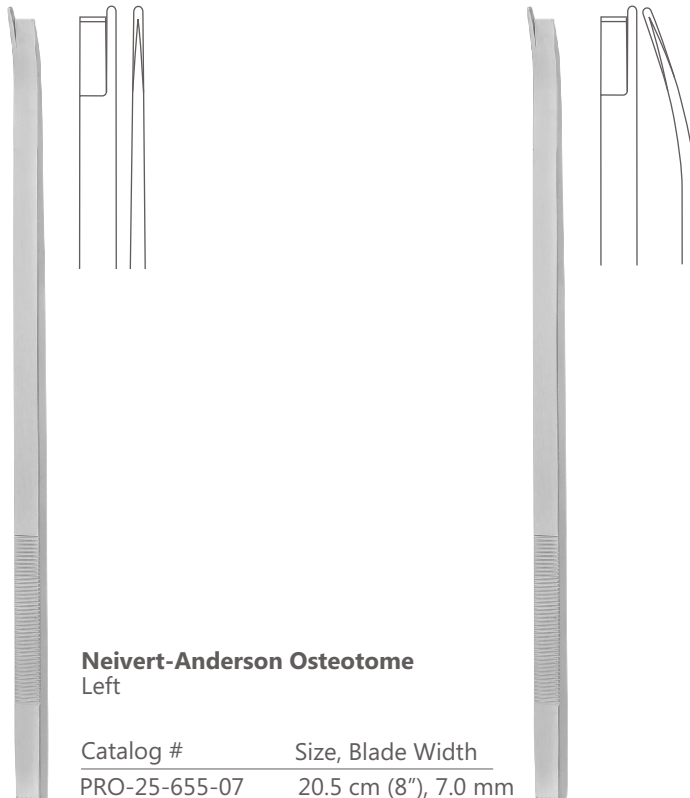

**Neivert-Anderson Osteotome  
Straight**

Catalog #	Size, Blade Width
PRO-25-654-07	20.5 cm (8"), 7.0 mm

**Neivert-Anderson Osteotome  
Left**

Catalog #	Size, Blade Width
PRO-25-655-07	20.5 cm (8"), 7.0 mm

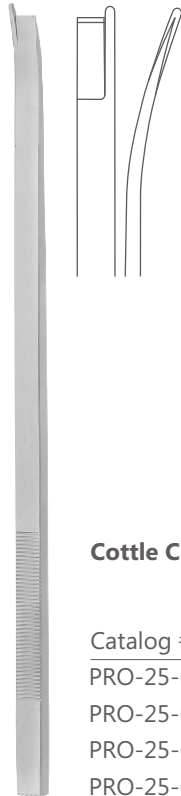

**Cottle Chisel**

Catalog #	Size, Blade Width
PRO-25-660-04	18 cm (7"), 4.0 mm
PRO-25-660-07	18 cm (7"), 7.0 mm
PRO-25-660-09	18 cm (7"), 9.0 mm
PRO-25-660-12	18 cm (7"), 12.0 mm



**Neivert-Anderson Osteotome Right**

Catalog #	Size, Blade Width
PRO-25-657-07	20.5 cm (8"), 7.0 mm



**Sheehan Osteotome**

Catalog #	Size, Blade Width
PRO-25-664-01	15 cm (6"), 1.0 mm
PRO-25-664-02	15 cm (6"), 2.0 mm
PRO-25-664-03	15 cm (6"), 3.0 mm
PRO-25-664-04	15 cm (6"), 4.0 mm
PRO-25-664-05	15 cm (6"), 5.0 mm
PRO-25-664-06	15 cm (6"), 6.0 mm
PRO-25-664-07	15 cm (6"), 7.0 mm
PRO-25-664-08	15 cm (6"), 8.0 mm
PRO-25-664-10	15 cm (6"), 10.0 mm
PRO-25-664-12	15 cm (6"), 12.0 mm

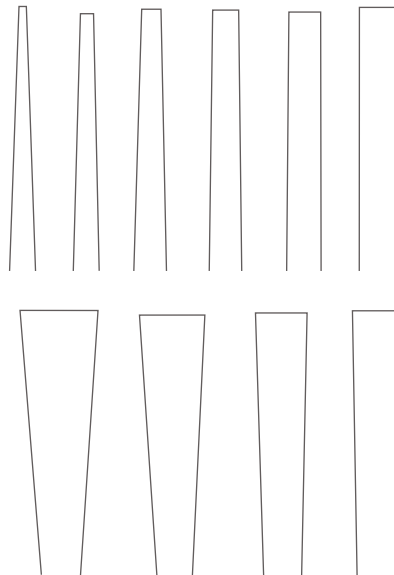



**Silver Chisel**  
Straight

Catalog #	Size, Blade Width
PRO-25-666-05	18 cm (7"), 5.0 mm

**Silver Chisel**  
Right

Catalog #	Size, Blade Width
PRO-25-667-05	18 cm (7"), 5.0 mm



**Silver Chisel**  
Left Curved

Catalog #	Size, Blade Width
PRO-25-669-05	18 cm (7"), 5.0 mm

**Parkes Osteotome**

Catalog #	Size
PRO-25-672-01	16 cm (6 ¼")



**Joseph Nasal Saw**

Catalog #	Size, Profile
PRO-25-691-01	17 cm (6 ¾"), Angled to Left
PRO-25-691-02	17 cm (6 ¾"), Angled to Right

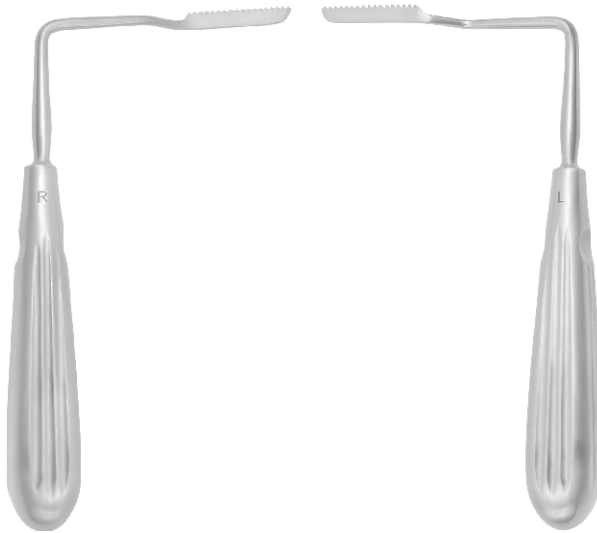

**Joseph Nasal Saw  
Straight**

Catalog #	Size, Working Length
PRO-25-692-19	19 cm (7 ½"), 40.0 mm



**Joseph Nasal Saw  
Bayonet Shaped**

Catalog #	Size, Working Length
PRO-25-693-01	19 cm (7 ½"), 40.0 mm
PRO-25-693-02	19 cm (7 ½"), 40.0 mm



**Cottle Cartilage Crusher**



Catalog #	Size
PRO-25-698-00	Standard

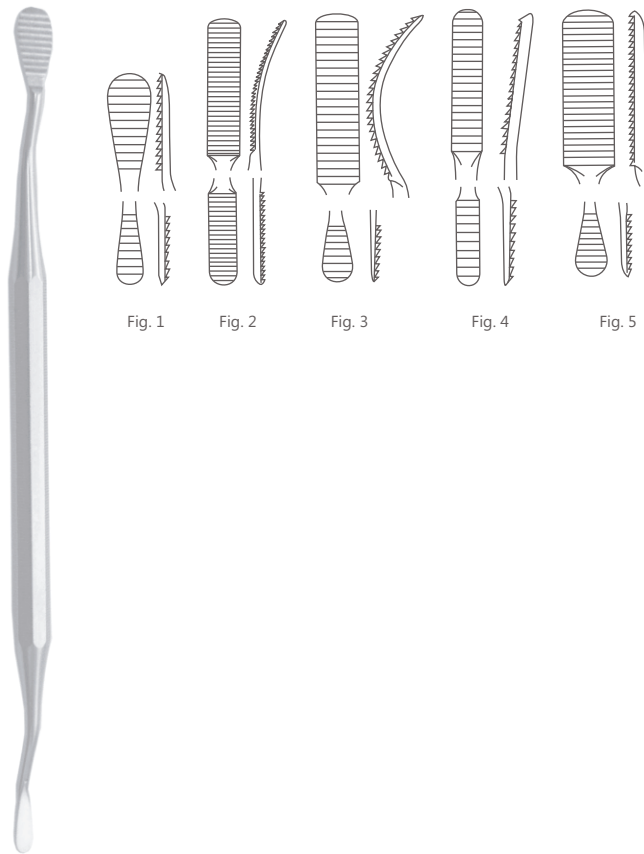

**Miller-Colburn Bone File**  
Drawing Cut

Catalog #	Size, Profile
PRO-25-701-01	18 cm (7"), Fig. 1
PRO-25-701-02	18 cm (7"), Fig. 2
PRO-25-701-03	18 cm (7"), Fig. 3
PRO-25-701-04	18 cm (7"), Fig. 4
PRO-25-701-05	18 cm (7"), Fig. 5

Fig. 1

Fig. 2

Fig. 3

Fig. 4

Fig. 5

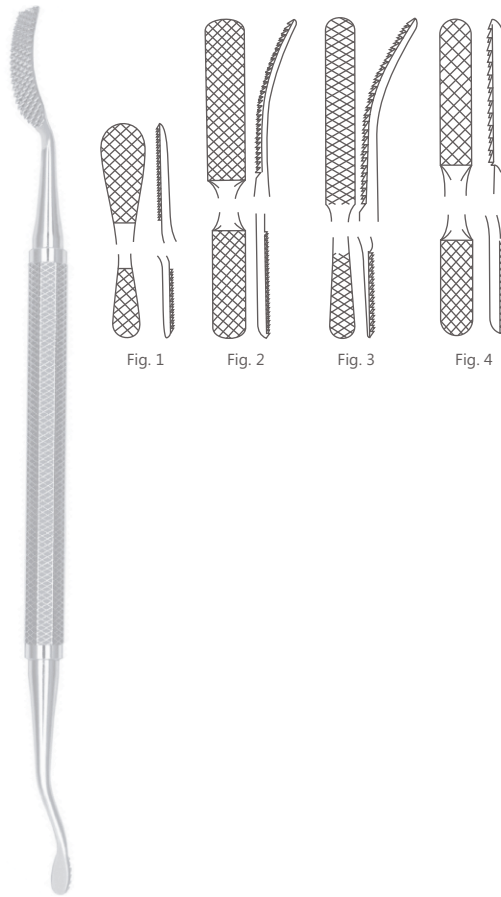

**Miller-Colburn Bone File**  
Cross Cut

Catalog #	Size, Profile
PRO-25-703-01	18 cm (7"), Fig. 1
PRO-25-703-02	18 cm (7"), Fig. 2
PRO-25-703-03	18 cm (7"), Fig. 3
PRO-25-703-04	18 cm (7"), Fig. 4

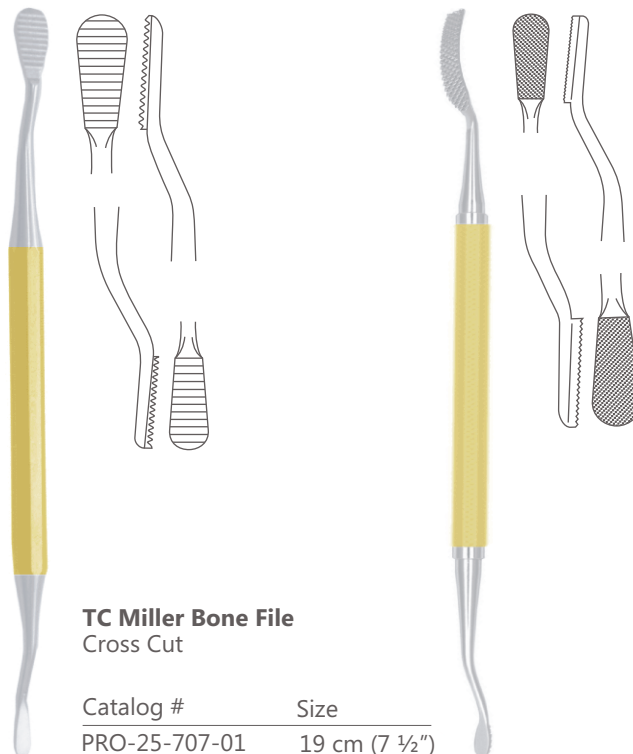

**TC Miller Bone File**  
Drawing Cut

Catalog #	Size
PRO-25-705-01	19 cm (7 1/2")

**TC Miller Bone File**  
Cross Cut

Catalog #	Size
PRO-25-707-01	19 cm (7 1/2")





**Maltz Nasal Rasp**  
Drawing Cut

Catalog #	Size, Cutting Edge
PRO-25-710-18	17.5 cm (7"), 40 x 9 mm

**Maltz Nasal Rasp**

Catalog #	Size, Cutting Edge, Profile
PRO-25-712-01	17 cm (6 3/4"), 34 x 7 mm, Drawing Cut
PRO-25-712-02	17 cm (6 3/4"), 34 x 7 mm, Pushing Cut

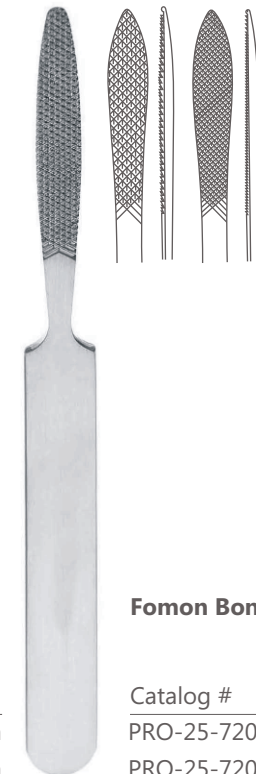

**Joseph Bone File**

Catalog #	Size, Cutting Edge
PRO-25-714-01	16 cm (6 1/4"), 60 x 8 mm
PRO-25-714-02	16 cm (6 1/4"), 45 x 9 mm

**Fomon Bone File**

Catalog #	Size, Cutting Edge
PRO-25-720-01	21 cm (8 1/4"), 30 x 8 mm
PRO-25-720-02	21 cm (8 1/4"), 30 x 8 mm





**Parkes Bone File**  
Drawing Cut

Catalog #	Size, Cutting Edge
PRO-25-722-01	19.5 cm (7 3/4"), 35 x 8 mm
PRO-25-722-02	19.5 cm (7 3/4"), 35 x 10 mm

**Gallaher Antrum Rasp**

Catalog #	Size, Cutting Edge
PRO-25-724-01	17 cm (6 3/4"), 45 x 6 mm
PRO-25-724-02	17 cm (6 3/4"), 45 x 6 mm
PRO-25-724-03	17 cm (6 3/4"), 45 x 6 mm



**Cottle Nasal Rasp**

Catalog #	Size, Cutting Edge
PRO-25-726-21	20.5 cm (8"), 30 x 8 mm

**Aufricht Glabella Rasp**

Catalog #	Size, Cutting Edge, Profile
PRO-25-729-01	21 cm (8 1/4"), 32 x 9 mm, Pushing Cut
PRO-25-729-02	21 cm (8 1/4"), 32 x 9 mm, Drawing Cut

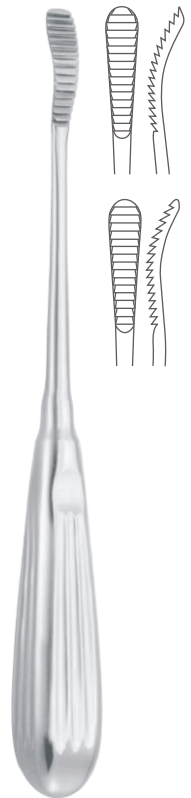



**Lewis Nasal Rasp**  
Drawing Cut

Catalog #	Size, Cutting Edge
PRO-25-732-01	19 cm (7 ½"), 15 x 8 mm
PRO-25-732-02	19 cm (7 ½"), 15 x 8 mm



**Wiener Nasal Rasp**

Catalog #	Size
PRO-25-735-18	18 cm (7")



**Bone File**  
Straight

Catalog #	Size
PRO-25-738-19	19 cm (7 ½")



**Bone File**  
Curved

Catalog #	Size
PRO-25-739-19	19 cm (7 ½")



**TC Maltz Nasal Rasp**

Catalog #	Size
PRO-25-742-01	19.5 cm (7 3/4")
PRO-25-742-02	19.5 cm (7 3/4")
PRO-25-742-03	19.5 cm (7 3/4")
PRO-25-742-04	19.5 cm (7 3/4")
PRO-25-742-05	19.5 cm (7 3/4")
PRO-25-742-06	19.5 cm (7 3/4")
PRO-25-742-07	19.5 cm (7 3/4")
PRO-25-742-08	19.5 cm (7 3/4")
PRO-25-742-09	19.5 cm (7 3/4")
PRO-25-742-10	19.5 cm (7 3/4")

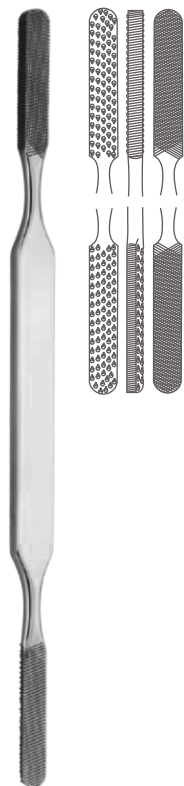

**Fomon Nasal Rasp**

Catalog #	Size, Cutting Edge
PRO-25-744-21	20.5 cm (8"), 30 x 8 mm

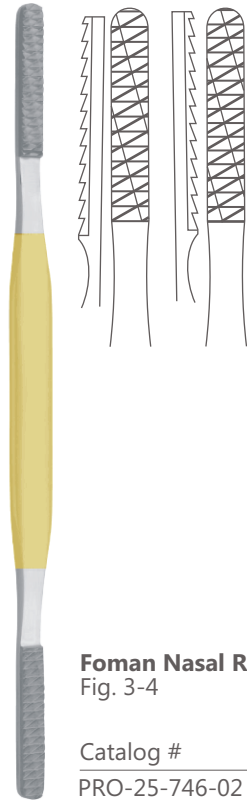

**Foman Nasal Rasp**  
Fig. 1-2

Catalog #	Size, Cutting Edge
PRO-25-746-01	20.5 cm (8"), 30 x 8 mm

**Foman Nasal Rasp**  
Fig. 3-4

Catalog #	Size, Cutting Edge
PRO-25-746-02	20.5 cm (8"), 40 x 7 mm

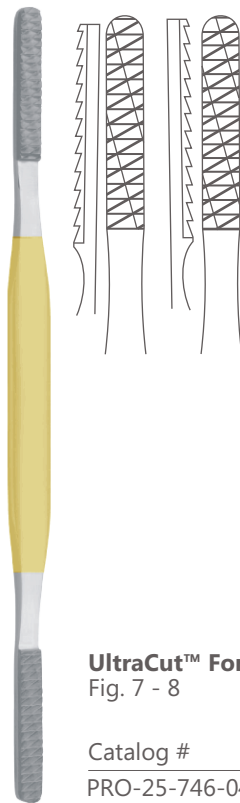
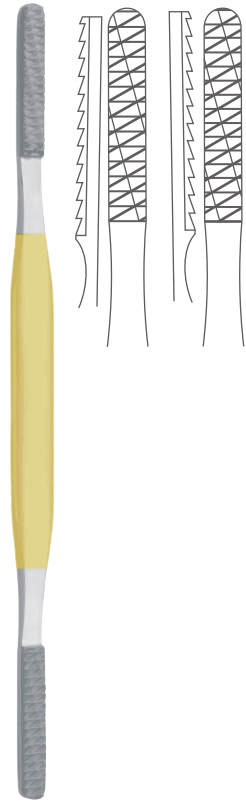

**Foman Nasal Rasp**  
Fig. 5-6

Catalog #	Size, Cutting Edge
PRO-25-746-03	20.5 cm (8"), 40 x 7 mm

**UltraCut™ Foman Nasal Rasp**  
Fig. 7 - 8

Catalog #	Size, Cutting Edge
PRO-25-746-04	20.5 cm (8"), 40 x 7 mm

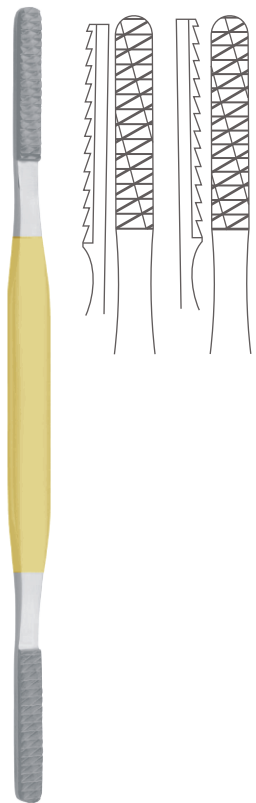

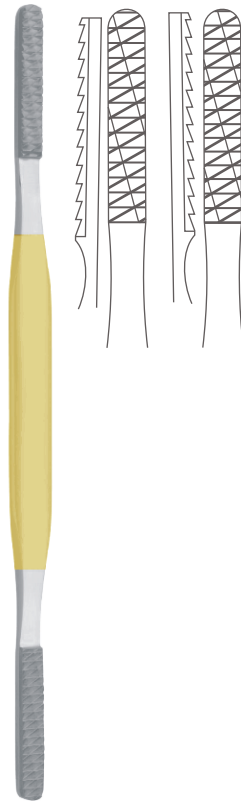

**UltraCut™ Foman Nasal Rasp**

Fig. 9 - 10

Catalog #	Size, Cutting Edge
PRO-25-746-05	20.5 cm (8"), 40 x 7 mm



**Lange Alar Hook**  
Button End

Catalog #	Size
PRO-25-761-22	23 cm (9")

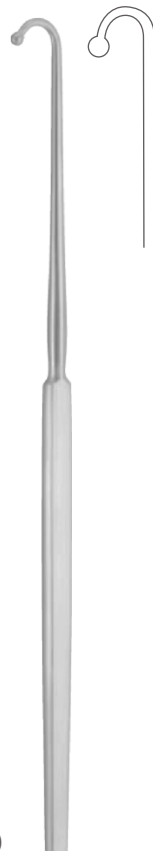

**Fomon Alar Hook**  
Button End

Catalog #	Size
PRO-25-763-17	17 cm (6 ¾")

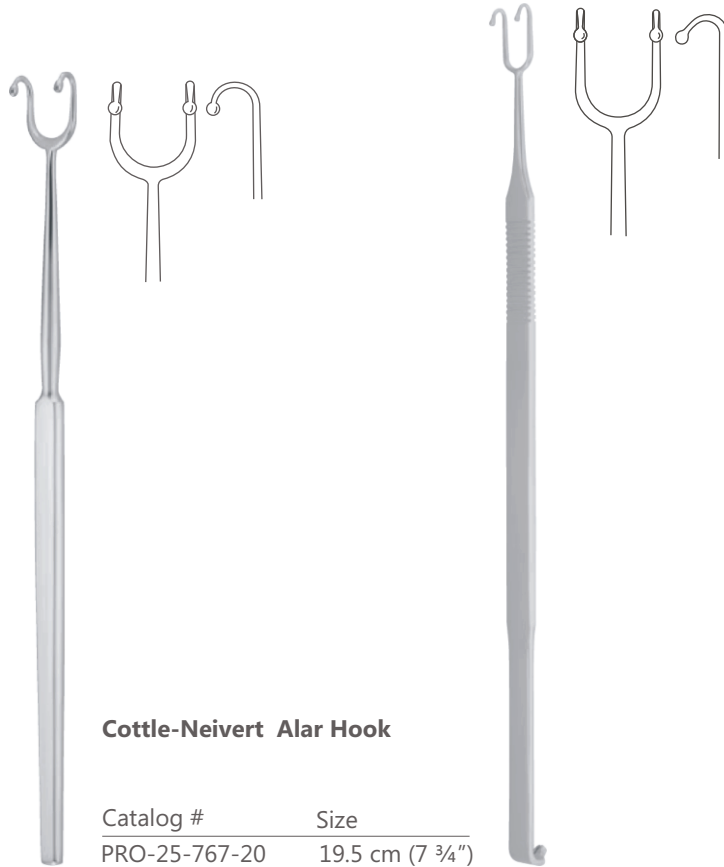

**Fomon Alar Hook**  
Button Ended

Catalog #	Size
PRO-25-765-16	16 cm (6 1/4")

**Cottle-Neivert Alar Hook**

Catalog #	Size
PRO-25-767-20	19.5 cm (7 3/4")

**Cottle Alar Hook**

Catalog #	Size
PRO-25-771-01	14.5 cm (5 3/4"), Sharp
PRO-25-771-02	14.5 cm (5 3/4"), Blunt, Sharp
PRO-25-771-03	14.5 cm (5 3/4"), Sharp, Blunt

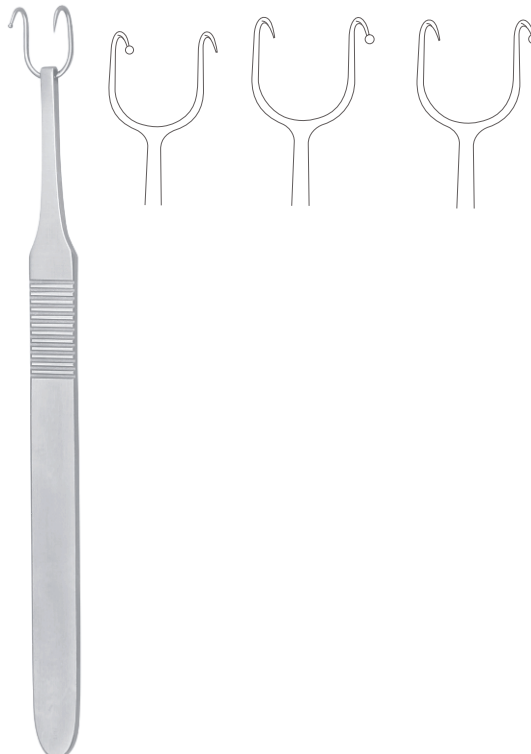



**Converse Nasal Retractor**

Catalog #	Size, Blade Size
PRO-25-781-01	9 cm (3 1/2"), 18 x 9.5 mm
PRO-25-781-02	9 cm (3 1/2"), 28 x 12.5 mm
PRO-25-781-03	9 cm (3 1/2"), 41 x 13.5 mm
PRO-25-781-04	9 cm (3 1/2"), 53 x 13.5 mm

**Aufricht Nasal Retractor**

Catalog #	Size, Blade Size
PRO-25-785-19	19 cm (7 1/2"), 40 x 12 mm

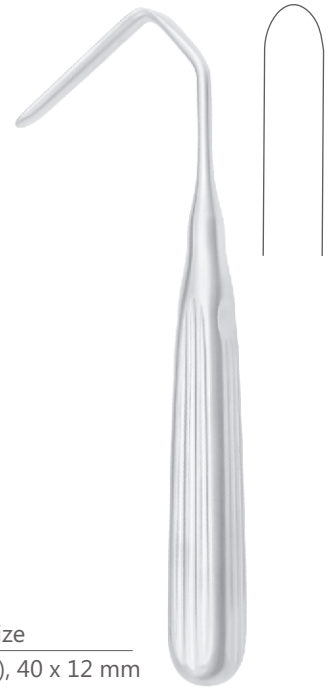

**Converse Nasal Retractor**

Catalog #	Size, Blade Size
PRO-25-787-11	10.5 cm (4"), 44 x 11 mm



**Neivert Nasal Retractor**

Catalog #	Size
PRO-25-789-16	17 cm (6 3/4")

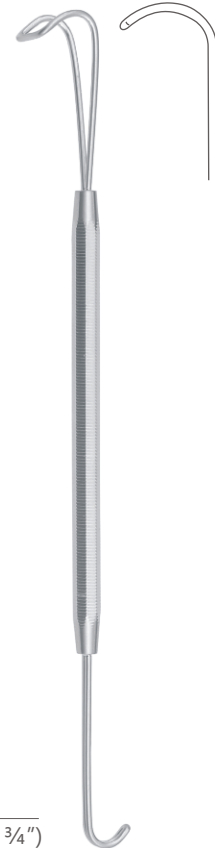





**Cottle Alar Retractor**

Catalog #	Size
PRO-25-791-15	16 cm (6 ¼")



**Aufrecht Nasal Retractor  
Blunt**

Catalog #	Size, Blade Size
PRO-25-793-14	12 cm (4 ¾"), 60 x 6.5 mm



**Kressner Septum Forcep**

Catalog #	Size
PRO-25-801-20	21 cm (8 ¼")

**Cottle-Walsham Septum Straightning Forcep**

Catalog #	Size, Profile
PRO-25-804-01	23 cm (9"), Straight
PRO-25-804-02	23 cm (9"), Left
PRO-25-804-03	23 cm (9"), Right





**Asch Septum Straightning Forcep**

Catalog #	Size
PRO-25-807-23	22.5 cm (8 ¾")

**Aiach Columella Suturing Forcep**

Catalog #	Size, Width
PRO-25-811-15	15.5 cm (6"), 5.0 mm



**Ogura Sking Grasping Forcep**

Catalog #	Size, Width
PRO-25-814-11	11 cm (4 ¼"), 4.0 mm

**Cottle Sking Grasping Forcep**

Catalog #	Size, Width
PRO-25-817-14	14 cm (5 ½"), 1.7 mm



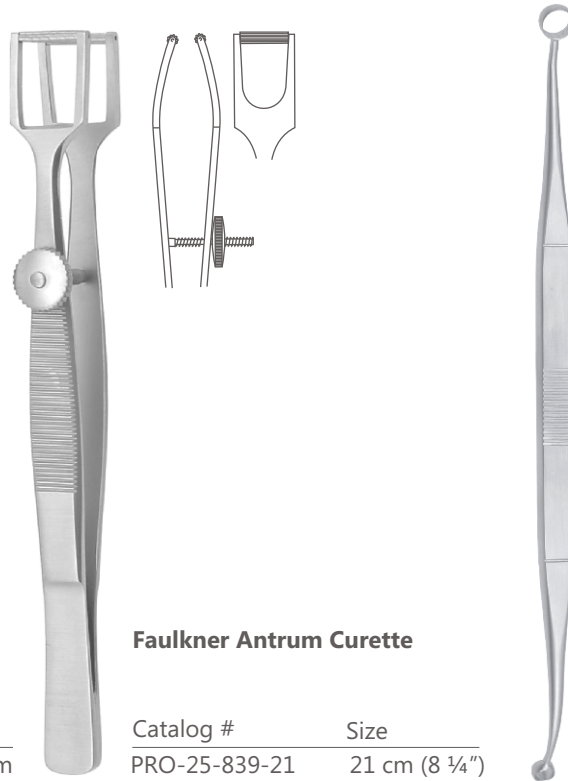

**Cottle Columella Forcep**

Catalog #	Size, Width
PRO-25-820-11	11 cm (4 1/4"), 12.0 mm

**Faulkner Antrum Curette**

Catalog #	Size
PRO-25-839-21	21 cm (8 1/4")



**Coakley Antrum Curette**

Catalog #	Size
PRO-25-841-01	17 cm (6 3/4")
PRO-25-841-02	17 cm (6 3/4")
PRO-25-841-03	17 cm (6 3/4")
PRO-25-841-04	17 cm (6 3/4")
PRO-25-841-05	17 cm (6 3/4")
PRO-25-841-06	17 cm (6 3/4")

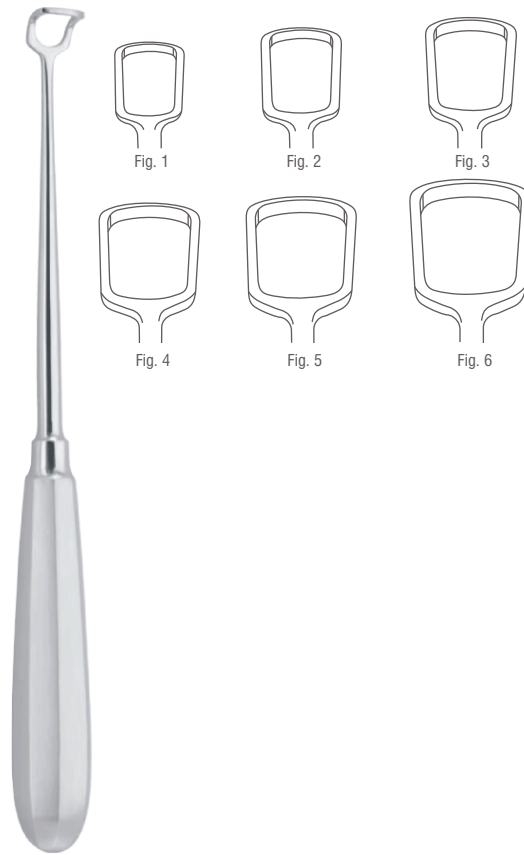

**Beckmann Adenoid Curette**

Catalog #	Size, Width , Profile
PRO-25-851-01	22.5 cm (8 3/4"), 13.0 mm, Fig. 1
PRO-25-851-02	22.5 cm (8 3/4"), 15.0 mm, Fig. 2
PRO-25-851-03	22.5 cm (8 3/4"), 17.0 mm, Fig. 3
PRO-25-851-04	22.5 cm (8 3/4"), 19.0 mm, Fig. 4
PRO-25-851-05	22.5 cm (8 3/4"), 21.0 mm, Fig. 5
PRO-25-851-06	22.5 cm (8 3/4"), 23.0 mm, Fig. 6

**Beckmann Adenoid Curette  
Angled Shaft**

Catalog #	Size, Width, Profile
PRO-25-853-01	22 cm (8 3/4"), 13.0 mm, Fig. 1
PRO-25-853-02	22 cm (8 3/4"), 15.0 mm, Fig. 2
PRO-25-853-03	22 cm (8 3/4"), 17.0 mm, Fig. 3
PRO-25-853-04	22 cm (8 3/4"), 19.0 mm, Fig. 4
PRO-25-853-05	22 cm (8 3/4"), 21.0 mm, Fig. 5
PRO-25-853-06	22 cm (8 3/4"), 23.0 mm, Fig. 6



**Barnhill Adenoid Curette**

Catalog #	Size, Profile
PRO-25-855-01	22 cm (8 3/4"), Fig. 1
PRO-25-855-02	22 cm (8 3/4"), Fig. 2
PRO-25-855-03	22 cm (8 3/4"), Fig. 3
PRO-25-855-04	22 cm (8 3/4"), Fig. 4



**St. Clair Thompson Adenoid Curette**

Catalog #	Size, Profile
PRO-25-857-01	21 cm (8 1/4"), Fig. 1
PRO-25-857-02	21 cm (8 1/4"), Fig. 2
PRO-25-857-03	21 cm (8 1/4"), Fig. 3
PRO-25-857-04	21 cm (8 1/4"), Fig. 4



**LaForce Adenotome**  
With Non-Perforated Blade

Catalog #	Size, Profile
PRO-25-861-01	25 cm (9 3/4"), Fig. 1
PRO-25-861-02	25 cm (9 3/4"), Fig. 2
PRO-25-861-03	25 cm (9 3/4"), Fig. 3



**LaForce Blade**  
Non-Perforated

Catalog #	Size
PRO-25-861-11	Standard
PRO-25-861-12	Standard
PRO-25-861-13	Standard



**LaForce Adenotome**  
With Perforated Blade

Catalog #	Size, Profile
PRO-25-863-01	25 cm (9 3/4"), Fig. 1
PRO-25-863-02	25 cm (9 3/4"), Fig. 2
PRO-25-863-03	25 cm (9 3/4"), Fig. 3



**LaForce Blade**  
Perforated

Catalog #	Size
PRO-25-863-11	Standard
PRO-25-863-12	Standard
PRO-25-863-13	Standard



**Eicken-Killian Irrigation**

Catalog #	Size, Diameter
PRO-25-881-14	14 cm (5 1/2"), Ø 3.0 mm



**Ritter-Halle Frontal Sinus Dilator**

Catalog #	Size, Diameter
PRO-25-891-25	14.5 cm (5 3/4"), Ø 2.5 mm
PRO-25-891-30	14.5 cm (5 3/4"), Ø 3.0 mm
PRO-25-891-40	14.5 cm (5 3/4"), Ø 4.0 mm

