



PRECISION[™]
SURGICAL WORKS

TONSILLECTOMY, LARYNGO-BRONCHOSCOPY

Tonsillektomie, Laryngo-Bronchoskopie
Tonsilectomia, Laringo-Bronchoscopia
Tonsillectomie, Laryngo-Bronchoskopie
Tonsilectomia, Laringo-Bronchoscopia





Fisher Tonsil / Dissector

Catalog #	Size
PRO-24-011-21	21.5 cm (8 ½")

Abraham Tonsil Knife

Catalog #	Size
PRO-24-015-19	19 cm (7 ½")

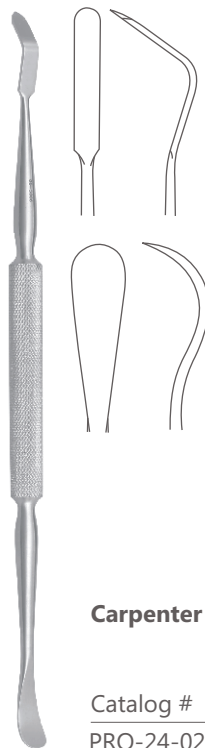

Carpenter Tonsil Knife

Catalog #	Size, Blade Width
PRO-24-021-25	25 cm (9 ¾"), 4.4 mm, 8.8 mm

Carpenter Tonsil Dissector

Catalog #	Size
PRO-24-027-24	24 cm (9 ½")





Hurd Tonsil Dissector / Retractor

Catalog #	Size, Blade Width
PRO-24-031-22	22.5 cm (8 ¾"), 11.0, 14.0 mm

Henke Tonsil Elevator

Catalog #	Size, Blade Width
PRO-24-037-23	22.5 cm (8 ¾"), 10.0, 5.0 mm

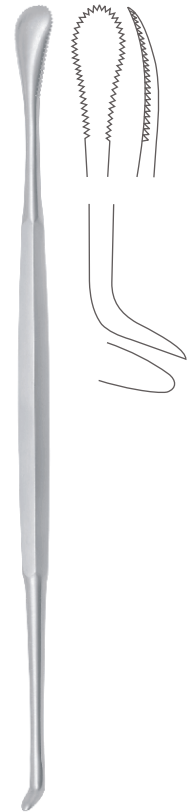

Henke Tonsil Elevator

Catalog #	Size, Blade Width
PRO-24-039-23	22.5 cm (8 ¾"), 16.0, 5.0 mm

Gwynne-Evan Tonsil Elevator

Catalog #	Size
PRO-24-043-22	20 cm (8")





Love Tonsil Retractor

Catalog #	Size, Blade Width
PRO-24-051-18	20 cm (8"), 18 mm
PRO-24-051-20	23 cm (9"), 20 mm
PRO-24-051-22	23 cm (9"), 22 mm

Nager Tonsil Retractor

Catalog #	Size
PRO-24-055-23	23 cm (9")



Hofer Tonsil Retractor

Catalog #	Size
PRO-24-059-24	24 cm (9 ½")

Haslinger Tonsil Retractor

Catalog #	Size
PRO-24-063-17	17 cm (6 ¾")





Luniatschek Gauze Packer

Catalog #	Size, Width
PRO-24-073-19	17.5 cm (7"), 3 mm
PRO-24-073-20	17.5 cm (7"), 2 mm

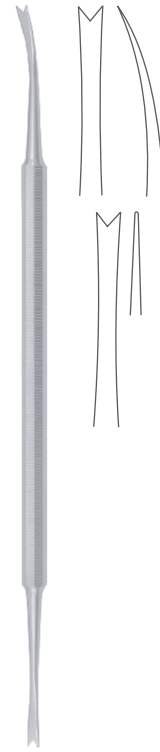

Roeder Tonsil Ligator

Catalog #	Size
PRO-24-065-00	26.5 cm (10 1/2")



White Tonsil Grasping Forcep

Catalog #	Size
PRO-24-101-18	18 cm (7")

**Blohmke Tonsil Grasping Forcep
1 x 2 Teeth**

Catalog #	Size
PRO-24-105-20	20 cm (8")

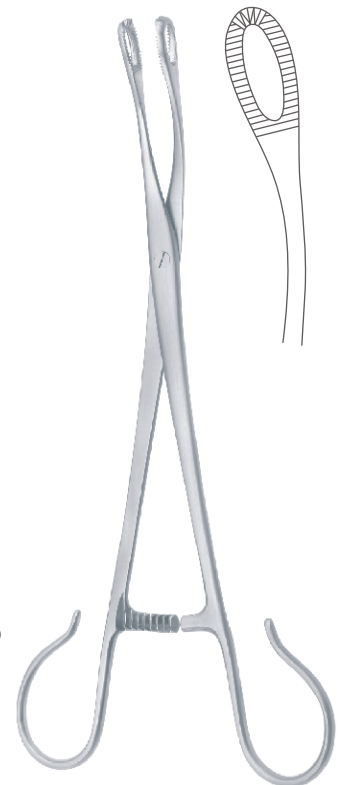

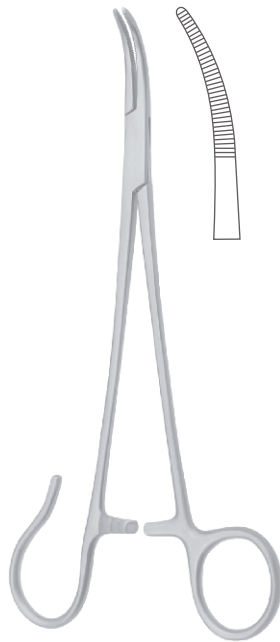

Schnidt Tonsil Forcep

Catalog #	Size
PRO-24-111-19	19 cm (7 ½")

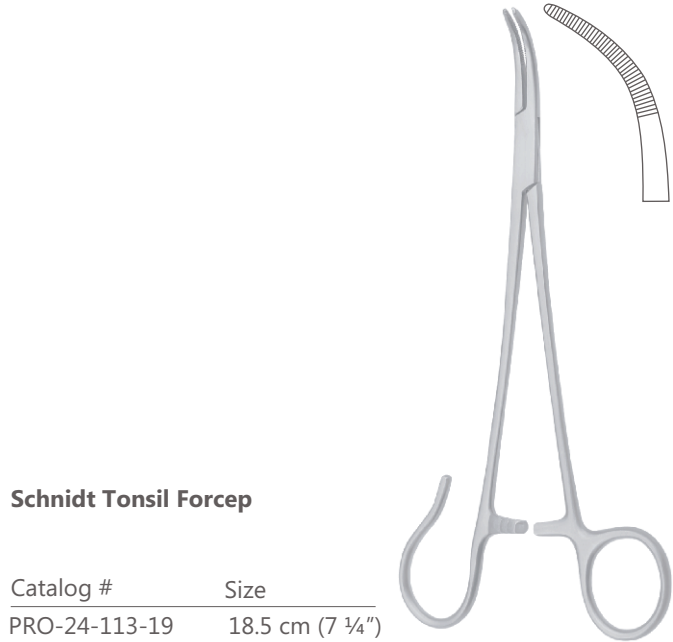

Schnidt Tonsil Forcep

Catalog #	Size
PRO-24-113-19	18.5 cm (7 ¼")

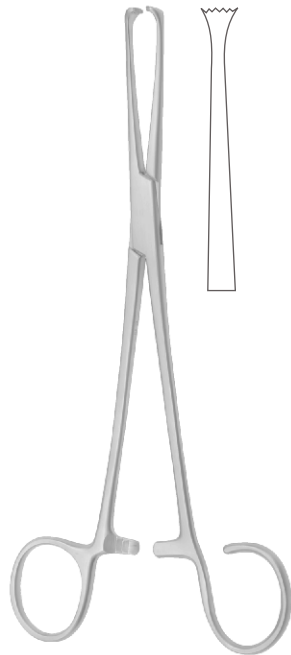

Colver Tonsil Grasping Forcep
Straight

Catalog #	Size
PRO-24-116-19	19 cm (7 ½")

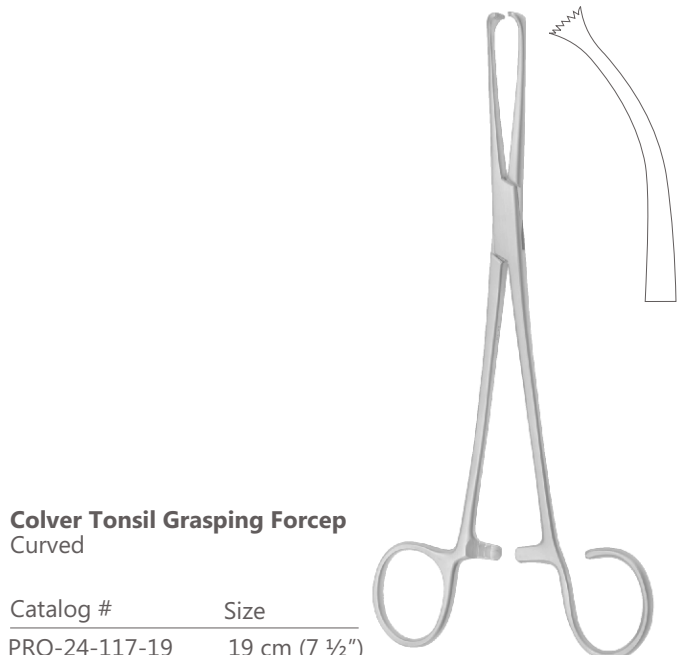

Colver Tonsil Grasping Forcep
Curved

Catalog #	Size
PRO-24-117-19	19 cm (7 ½")



Museux Tonsil Grasping Forcep
Curved

Catalog #	Size
PRO-24-120-20	20 cm (8")



Eves Tonsil Snare
Without Ratchet

Catalog #	Size
PRO-24-150-28	28.5 cm (11 ¼")



Eves Tonsil Snare
With Ratchet

Catalog #	Size
PRO-24-152-28	28.5 cm (11 ¼")



Bruenings Tonsil Snare
With Double Ratchet

Catalog #	Size
PRO-24-156-29	29 cm (11 ½")

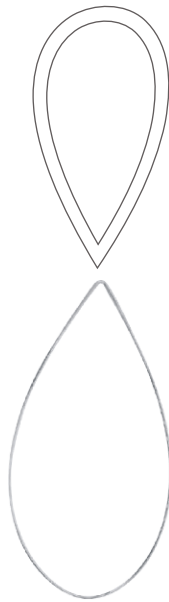

Wire Loop for Tonsil Snare

Pack of 100

Catalog #	Size, Loop Diameter
PRO-24-161-40	Ø 40.0 mm
PRO-24-161-50	Ø 50.0 mm

Snare Wire
Pack of 100

Catalog #	Size, Wire Diameter
PRO-24-163-00	Ø 0.3 mm

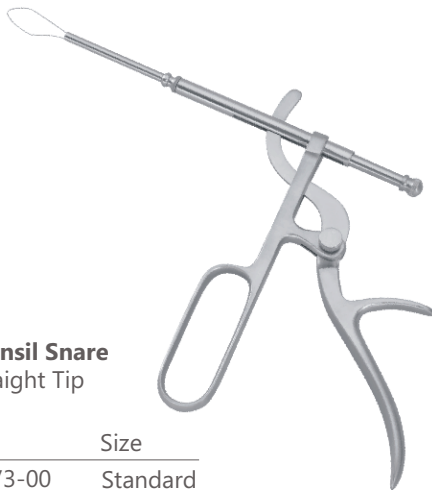

Tyding Tonsil Snare
With 1 Straight Tip

Catalog #	Size
PRO-24-173-00	Standard



Sluder-Ballenger Tonsillectome Completer
With 3 Tip

Catalog #	Size
PRO-24-181-00	Standard



Sluder-Ballenger Tonsillectome Handle Only

Catalog #	Size
PRO-24-181-01	Standard

Sluder-Ballenger Tonsillectome Tip

Catalog #	Size, Profile
PRO-24-183-01	Standard, Fig. 1
PRO-24-183-02	Standard, Fig. 2
PRO-24-183-03	Standard, Fig. 3

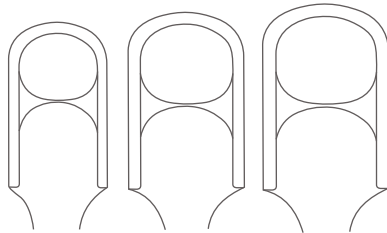

Corwin Tonsil Hemostat

Catalog #	Size
PRO-24-191-14	14 cm (5 1/2")

Hartmann Tonsil Punch Through Cutting

Catalog #	Size, Diameter
PRO-24-201-13	12 cm (4 3/4"), Ø 13.0 mm
PRO-24-201-15	12 cm (4 3/4"), Ø 15.0 mm
PRO-24-201-17	12 cm (4 3/4"), Ø 17.0 mm



Schmeden Tonsil Punch
Through Cutting

Catalog #	Size
PRO-24-213-01	12 cm (4 ¾")
PRO-24-213-02	12 cm (4 ¾")
PRO-24-213-03	12 cm (4 ¾")



Huber Universal Handle

Catalog #	Size
PRO-24-301-01	Standard



Bruenings Interchangeable Tube
Straight

Catalog #	Size
PRO-24-302-20	20 cm (8")
PRO-24-302-30	30 cm (12")
PRO-24-302-40	40 cm (16")



Bruenings Interchangeable Tube
Curved

Catalog #	Size
PRO-24-303-20	20 cm (8")



Fraenkel Broncho-Esophagoscopy Forcep Tip



Catalog #	Size
PRO-24-310-01	Standard

Seiffert Broncho-Esophagoscopy Forcep Tip

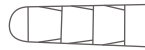

Catalog #	Size
PRO-24-314-01	Standard

Fraenkel Broncho-Esophagoscopy Forcep Tip



Catalog #	Size
PRO-24-318-01	Standard

Scheinmann Broncho-Esophagoscopy Forcep Tip



Catalog #	Size
PRO-24-321-01	Standard

Scheinmann Broncho-Esophagoscopy Forcep Tip



Catalog #	Size
PRO-24-323-01	Standard

Bruenings Broncho-Esophagoscopy Forcep Tip

Catalog #	Size
PRO-24-326-02	Standard
PRO-24-326-03	Standard

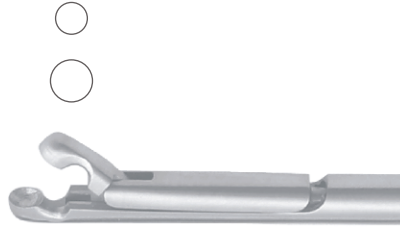

Bruenings Broncho-Esophagoscopy Forcep Tip

Catalog #	Size
PRO-24-328-02	Standard
PRO-24-328-03	Standard



Lange Broncho-Esophagoscopy Forcep Tip

Catalog #	Size
PRO-24-334-01	Standard



Krause Broncho-Esophagoscopy Forcep Tip

Catalog #	Size
PRO-24-338-01	Standard
PRO-24-338-02	Standard

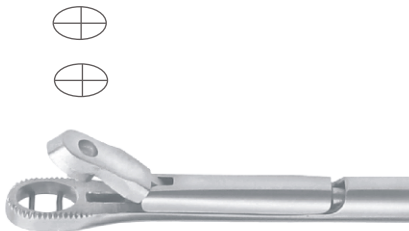

Krause Broncho-Esophagoscopy Forcep Tip

Catalog #	Size
PRO-24-342-01	Standard



Cordes Broncho-Esophagoscopy Forcep Tip

Catalog #	Size
PRO-24-347-01	Standard
PRO-24-347-02	Standard
PRO-24-347-03	Standard
PRO-24-347-04	Standard



Schumacher Broncho-Esophagoscopy Forcep Tip

Catalog #	Size
PRO-24-349-01	Standard



Cordes Broncho-Esophagoscopy Forcep Tip

Catalog #	Size
PRO-24-353-01	Standard
PRO-24-353-02	Standard



Cordes Broncho-Esophagoscopy Forcep Tip

Catalog #	Size
PRO-24-357-01	Standard



Rosenberg Broncho-Esophagoscopy Forcep Tip

Catalog #	Size
PRO-24-367-01	Standard



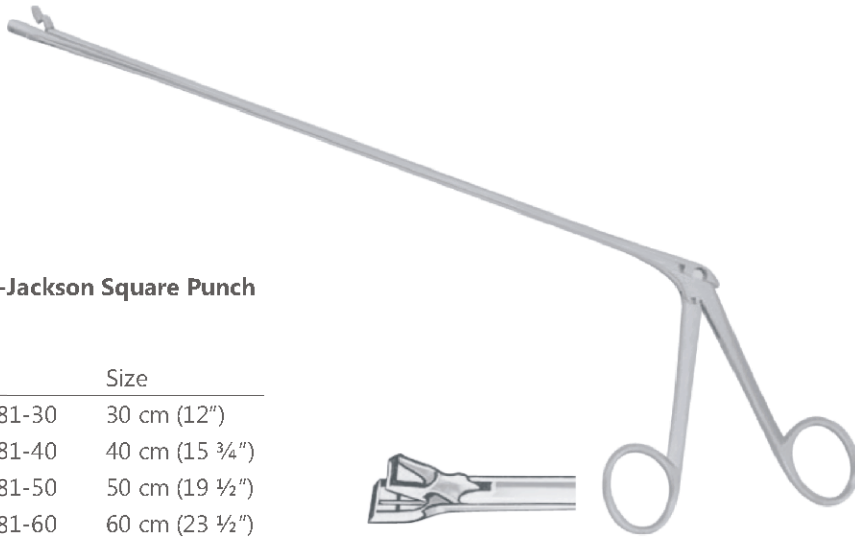

Chevalier-Jackson Square Punch

Catalog #	Size
PRO-24-381-30	30 cm (12")
PRO-24-381-40	40 cm (15 ¾")
PRO-24-381-50	50 cm (19 ½")
PRO-24-381-60	60 cm (23 ½")

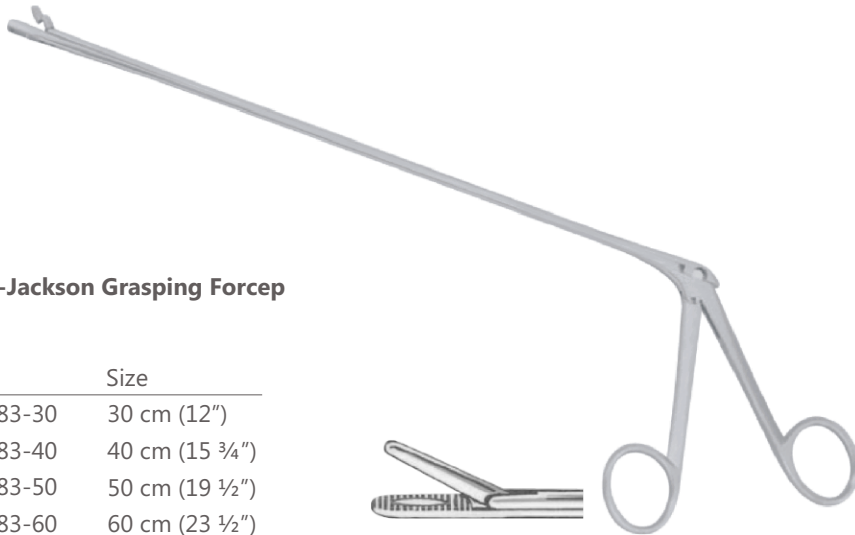

Chevalier-Jackson Grasping Forcep

Catalog #	Size
PRO-24-383-30	30 cm (12")
PRO-24-383-40	40 cm (15 ¾")
PRO-24-383-50	50 cm (19 ½")
PRO-24-383-60	60 cm (23 ½")

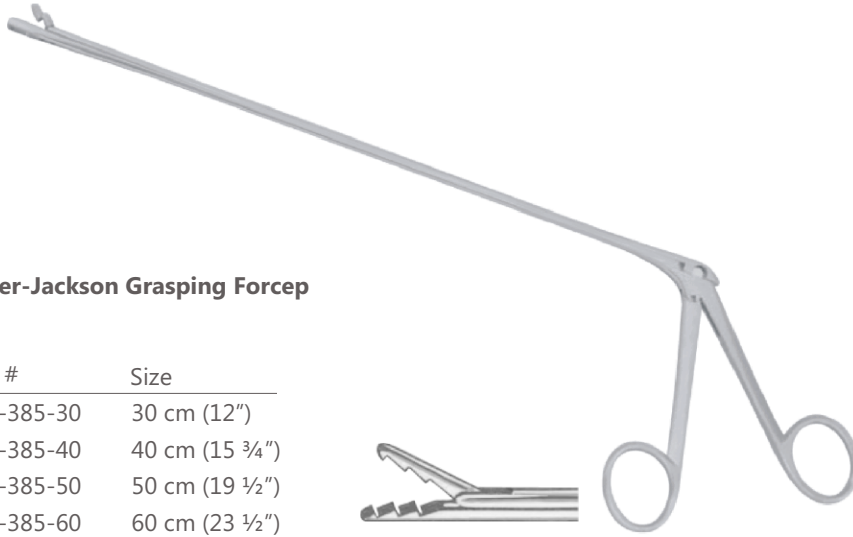

Chevalier-Jackson Grasping Forcep

Catalog #	Size
PRO-24-385-30	30 cm (12")
PRO-24-385-40	40 cm (15 ¾")
PRO-24-385-50	50 cm (19 ½")
PRO-24-385-60	60 cm (23 ½")

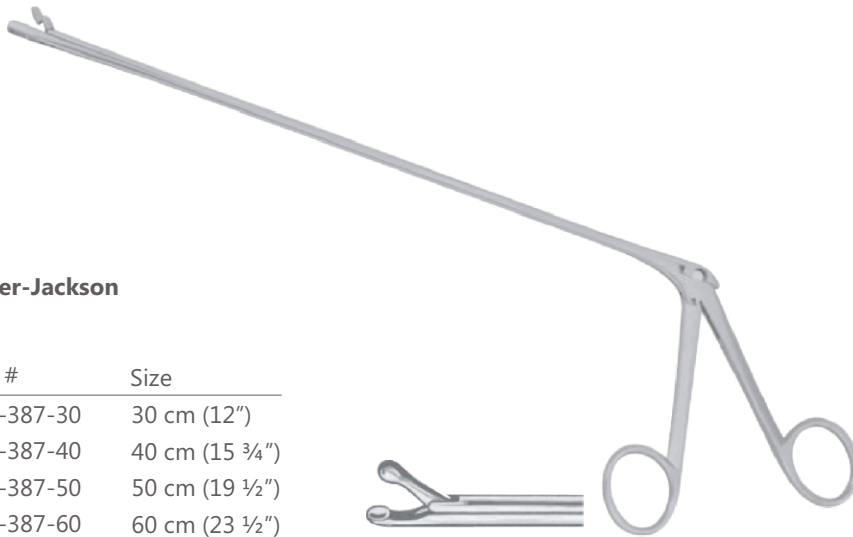

**Chevalier-Jackson
Straight**

Catalog #	Size
PRO-24-387-30	30 cm (12")
PRO-24-387-40	40 cm (15 ¾")
PRO-24-387-50	50 cm (19 ½")
PRO-24-387-60	60 cm (23 ½")

Chevalier-Jackson Basket Punch

Catalog #	Size
PRO-24-389-30	30 cm (12")
PRO-24-389-40	40 cm (15 3/4")
PRO-24-389-50	50 cm (19 1/2")
PRO-24-389-60	60 cm (23 1/2")



Chevalier-Jackson Oval Biopsy Forcep

Catalog #	Size
PRO-24-391-30	30 cm (12")
PRO-24-391-40	40 cm (15 3/4")
PRO-24-391-50	50 cm (19 1/2")
PRO-24-391-60	60 cm (23 1/2")



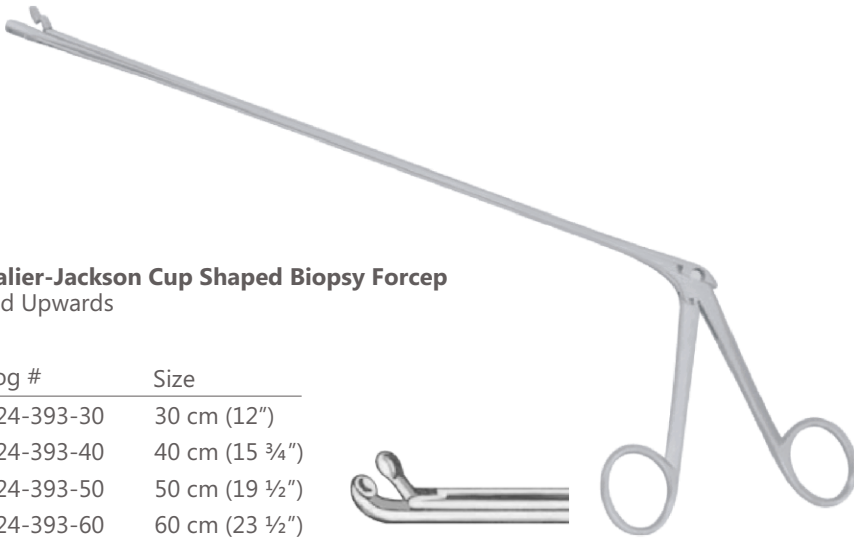

Chevalier-Jackson Cup Shaped Biopsy Forcep
Curved Upwards

Catalog #	Size
PRO-24-393-30	30 cm (12")
PRO-24-393-40	40 cm (15 3/4")
PRO-24-393-50	50 cm (19 1/2")
PRO-24-393-60	60 cm (23 1/2")

Laryngeal Mirror
Rhodium Plated With Fixed Handle

Catalog #	Size, Mirror Diameter, Profile
PRO-24-402-08	18.5 cm (7 1/4"), Ø 8 mm, Fig. 00
PRO-24-402-10	18.5 cm (7 1/4"), Ø 10 mm, Fig. 0
PRO-24-402-12	18.5 cm (7 1/4"), Ø 12 mm, Fig. 1
PRO-24-402-14	18.5 cm (7 1/4"), Ø 14 mm, Fig. 2
PRO-24-402-16	18.5 cm (7 1/4"), Ø 16 mm, Fig. 3
PRO-24-402-18	18.5 cm (7 1/4"), Ø 18 mm, Fig. 4
PRO-24-402-20	18.5 cm (7 1/4"), Ø 20 mm, Fig. 5
PRO-24-402-22	18.5 cm (7 1/4"), Ø 22 mm, Fig. 6
PRO-24-402-24	18.5 cm (7 1/4"), Ø 24 mm, Fig. 7
PRO-24-402-26	18.5 cm (7 1/4"), Ø 26 mm, Fig. 8
PRO-24-402-28	18.5 cm (7 1/4"), Ø 28 mm, Fig. 9
PRO-24-402-30	18.5 cm (7 1/4"), Ø 30 mm, Fig. 10



Laryngeal Mirror

Rhodium Plated Without Handle

Catalog #	Size, Mirror Diameter, Profile
PRO-24-406-08	13.5 cm (5 1/4"), Ø 8 mm, Fig. 00
PRO-24-406-10	13.5 cm (5 1/4"), Ø 10 mm, Fig. 0
PRO-24-406-12	13.5 cm (5 1/4"), Ø 12 mm, Fig. 1
PRO-24-406-14	13.5 cm (5 1/4"), Ø 14 mm, Fig. 2
PRO-24-406-16	13.5 cm (5 1/4"), Ø 16 mm, Fig. 3
PRO-24-406-18	13.5 cm (5 1/4"), Ø 18 mm, Fig. 4
PRO-24-406-20	13.5 cm (5 1/4"), Ø 20 mm, Fig. 5
PRO-24-406-22	13.5 cm (5 1/4"), Ø 22 mm, Fig. 6
PRO-24-406-24	13.5 cm (5 1/4"), Ø 24 mm, Fig. 7
PRO-24-406-26	13.5 cm (5 1/4"), Ø 26 mm, Fig. 8
PRO-24-406-28	13.5 cm (5 1/4"), Ø 28 mm, Fig. 9
PRO-24-406-30	13.5 cm (5 1/4"), Ø 30 mm, Fig. 10



Michel Laryngeal Mirror

With Handle , Moveable Mirror

Catalog #	Size, Mirror Diameter, Profile
PRO-24-413-12	25 cm (9 3/4"), Ø 12 mm, Fig. 1
PRO-24-413-14	25 cm (9 3/4"), Ø 14 mm, Fig. 2
PRO-24-413-16	25 cm (9 3/4"), Ø 16 mm, Fig. 3
PRO-24-413-18	25 cm (9 3/4"), Ø 18 mm, Fig. 4

Laryngeal Mirror Handle

Catalog #	Size
PRO-24-420-10	10 cm (4")

